



USING A COMPUTER WATER QUALITY MODEL TO DERIVE NUMERIC NUTRIENT CRITERIA

LOWER YELLOWSTONE RIVER, MT



SEPTEMBER 2011

PREPARED BY:
Montana Department of Environmental Quality
Water Quality Planning Bureau
1520 E. Sixth Avenue
P.O. Box 200901
Helena, MT 59620-0901



1
2
3
4
5
6
7
8
9
10
11
12
13
14
15
16
17
18
19
20
21
22
23
24
25
26
27
28
29
30
31
32
33
34
35
36
37
38
39
40
41
42
43
44
45
46
47
48

1
2
3
4
5
6
7
8
9
10
11
12
13
14
15
16
17
18
19
20
21
22
23
24
25
26
27
28
29
30
31
32
33
34
35
36
37
38
39
40

USING A COMPUTER WATER QUALITY MODEL TO DERIVE NUMERIC NUTRIENT CRITERIA

LOWER YELLOWSTONE RIVER, MT

WQPBDMSTECH-22

Kyle Flynn, P.H. and Michael Suplee, PhD

Suggested citation: Flynn, K. and M. W. Suplee. 2011. Using a computer water quality model to derive numeric nutrient criteria: Lower Yellowstone River. WQPBDMSTECH-22. Helena, MT: Montana Dept. of Environmental Quality.

Cover photo credits: Montana DEQ; Mark Greytak, MontanaPictures.Net

SEPTEMBER 2011

PREPARED BY:
Montana Department of Environmental Quality
Water Quality Planning Bureau
1520 E. Sixth Avenue
P.O. Box 200901
Helena, MT 59620-0901

1
2
3
4
5
6
7
8

1	CONTENTS	
2		
3	Executive Summary.....	i
4	Acknowledgements.....	vii
5	Acronyms	ix
6	Conversion Factors.....	xiii
7		
8	1.0 Introduction	1-1
9	1.1 Background of Numeric Nutrient Criteria Development in Montana.....	1-1
10	1.2 Mechanistic Models & Montana’s Proposed Large River Approach	1-2
11	1.3 Why Use a Water Quality Model.....	1-3
12	1.4 Large River Definition and Scope.....	1-3
13	1.5 Beneficial Uses of Montana Rivers and How Criteria Protect Them	1-4
14	1.6 Document Outline	1-5
15	2.0 The Problem of Eutrophication.....	2-1
16	2.1 How Eutrophication Affects Large Rivers	2-1
17	2.1.1 Human and Societal Effects	2-1
18	2.1.2 Ecological Impacts.....	2-2
19	2.1.3 Other Considerations	2-3
20	2.2 Factors that Influence Eutrophication in Large Rivers.....	2-3
21	2.2.1 Light.....	2-3
22	2.2.2 Velocity.....	2-5
23	2.2.3 Substrate	2-6
24	2.3 Sources of Nitrogen and Phosphorus to Rivers	2-6
25	2.3.1 Atmospheric Sources	2-6
26	2.3.2 Land-based Sources	2-6
27	3.0 The Control of Eutrophication	3-1
28	3.1 Time-Period for Nutrient Control	3-1
29	3.2 Total Nutrients as Recommended Criteria	3-4
30	3.3 Expected Difficulties with Numeric Nutrient Criteria Development	3-4
31	3.3.1 Concerns with Using Models.....	3-5
32	3.3.2 Longitudinal Variability of Proposed Criteria	3-5
33	3.3.3 Factors that Mitigate Eutrophication.....	3-5
34	3.3.4 Economics	3-5
35	4.0 Criteria Development for the Yellowstone River	4-1
36	4.1 Watershed Description.....	4-1
37	4.2 Lower River Study Area	4-2
38	4.3 Beneficial Uses and Water Quality Standards for the River	4-6
39	4.4 Limits of Criteria Derived in this Study	4-7
40	4.5 Historical Water Quality Summary	4-8
41	5.0 Modeling Strategy.....	5-1
42	5.1 Rationale for the Model DEQ Selected.....	5-1
43	5.2 QUAL2K Description	5-1
44	5.2.1 Conceptual Representation	5-2
45	5.2.2 Temperature Model.....	5-2
46	5.2.3 Constituent Model	5-3
47	5.3 General Data Requirements for QUAL2K	5-5

1	5.4 Assumptions and Limitations.....	5-5
2	5.5 Verification of Model Assumptions	5-6
3	5.6 AlgaeTransect2K (AT2K; a Q2K Cross-section Model)	5-7
4	5.7 Why the Transect Model (AT2K) was Needed.....	5-8
5	6.0 Project Design, Data Collection, and Supporting Studies	6-1
6	6.1 Summary of Field Data Collection to Support Modeling.....	6-1
7	6.2 Data Compilation and Supporting Information	6-1
8	6.2.1 Sources.....	6-1
9	6.2.2 Personal Communications and Supporting Data	6-2
10	6.2.3 Database	6-3
11	6.3 Data Analysis.....	6-6
12	6.4 Outside Studies Useful for Modeling.....	6-7
13	6.5 Other Pertinent Information	6-10
14	6.6 Data Quality, Detection Limits, and Significant Figures.....	6-11
15	7.0 Model Setup and Development.....	7-1
16	7.1 Flow Path (Centerline) Definition	7-1
17	7.2 Streamflow	7-3
18	7.2.1 Surface Water Summary	7-3
19	7.2.2 Groundwater.....	7-9
20	7.2.3 Evaporation.....	7-9
21	7.2.4 Water Balance During Summer 2007	7-9
22	7.3 Hydraulics and Mass Transport	7-13
23	7.3.1 Field Observations of Hydraulic Properties	7-14
24	7.3.2 USGS Rating Measurements	7-15
25	7.3.3 Dye Tracer Time of Travel Study.....	7-16
26	7.3.4 Interpretive Hydraulics	7-17
27	7.4 Atmospheric Model Input.....	7-21
28	7.4.1 Climatic Forcings	7-21
29	7.4.2 Carbon Dioxide and Aerial Deposition.....	7-26
30	7.5 Shade Analysis	7-27
31	7.6 Boundary Condition Data	7-29
32	7.6.1 Inflow Water Chemistry Data	7-29
33	7.6.2 Nutrient Load Estimates to the River.....	7-33
34	7.7 Data Uncertainty.....	7-36
35	8.0 Supporting Information for the Calibration.....	8-1
36	8.1 Sensitivity Analysis.....	8-1
37	8.2 Algal Taxonomy and Composition	8-4
38	8.3 Detached Drifting Filamentous Algae.....	8-5
39	8.4 Stoichiometry of Algae	8-5
40	8.5 Algal Growth Rate Experiments (Light-Dark Bottles)	8-7
41	8.6 Minimum Cell Quota (q_0) Estimates.....	8-11
42	8.7 Algal Nutrient Uptake Estimates	8-12
43	8.8 Reaeration	8-13
44	8.9 Sediment Oxygen Demand (SOD).....	8-14
45	8.10 Light Extinction and Suspended Particles.....	8-15
46	8.11 Settling Velocities	8-20
47	9.0 Model Calibration and Validation	9-2
48	9.1 Approach	9-2

1	9.2 Calibration and Validation Time-Period	9-3
2	9.3 Evaluation Criteria for Calibration and Validation.....	9-3
3	9.4 Data for Calibration	9-4
4	9.5 Water Chemistry Relationships with Model State-variables.....	9-6
5	9.6 Model Configuration and Solution	9-6
6	9.7 Model Calibration	9-7
7	9.7.1 Manual Calibration.....	9-8
8	9.7.2 Autocalibration	9-8
9	9.8. Calibrated Rates for Q2K on the Yellowstone River	9-8
10	10.0 Review of Model Output and Comparison to Field Data.....	10-1
11	10.1 Streamflow Hydrology.....	10-2
12	10.2 Mass Transport, Travel-time, and Reaeration.....	10-3
13	10.3 Water Temperature.....	10-5
14	10.4 Water Chemistry and Diurnal Water Quality Simulations.....	10-6
15	10.4.1 Suspended particles.....	10-7
16	10.4.2 Nutrients	10-9
17	10.4.3 Algae	10-15
18	10.4.4 Oxygen	10-24
19	10.4.5 Carbon.....	10-26
20	10.4.6 Conductivity	10-31
21	11.0 Model Evaluation Beyond the Original Validation.....	11-1
22	11.1 Phycological Evaluation and Growth Rate Changes as Evidenced by Algal Taxa	11-1
23	11.2 Cross-Validation with 2000 USGS data.....	11-2
24	11.3 Results.....	11-4
25	11.3.1 Streamflow Hydrology	11-4
26	11.3.2 Mass Transport	11-5
27	11.3.3 Water temperature.....	11-6
28	11.3.4 Suspended Particles	11-7
29	11.3.5 Nutrients	11-8
30	11.3.6 Algae	11-12
31	11.3.7 Oxygen	11-13
32	11.3.8 Carbon.....	11-14
33	11.3.9 Conductivity	11-16
34	11.4 Some Final Thoughts on the Model.....	11-16
35	12.0 Critical Low-flow Design Conditions for Nutrient Criteria	12-1
36	12.1 Design Flows for Water Quality Modeling Studies.....	12-1
37	12.2 Identifying an Appropriate Design Flow Duration.....	12-1
38	12.2.1 Algal Growth as an Indicator of Time to Nuisance Biomass	12-2
39	12.2.2 Enrichment Studies Detailing Algal Growth Kinetics	12-3
40	12.2.3 Justification of Time to Nuisance Algae Estimate	12-4
41	12.3 Low-flow Frequency Analysis	12-5
42	12.3.1 Seasonal n-day Low-flow Analysis (1968-2009).....	12-6
43	12.3.2 Low-flow Frequency Analysis.....	12-7
44	12.4 Final Design Flow Recommendation	12-9
45	12.5 Design Climate	12-9
46	12.5.1 Climatic Conditions Associated with the 14Q10.....	12-10
47	12.5.2 Typical Meteorological Year.....	12-10
48	12.5.3 Adjustments to the TMY Based on Field Observations.....	12-11

1	12.5.4 Extrapolation of TMY Data to the Other Climatic Regions in the Project.....	12-13
2	12.6 Water Quality Boundary Conditions.....	12-14
3	12.7 Other Boundary Conditions.....	12-16
4	13.0 Water Quality Model Nutrient Additions to Identify Numeric Criteria.....	13-1
5	13.1 Methodology Used to Identify Critical Nutrient Concentrations.....	13-1
6	13.2 Results of Nutrient Addition Simulations.....	13-6
7	13.3 Discussion.....	13-11
8	13.3.1. Nutrient Criteria Based on pH.....	13-12
9	13.3.2. Nutrient Criteria Based on Benthic Algae Biomass.....	13-12
10	13.3.3. Dissolved Oxygen Effects.....	13-14
11	13.3.4. Total Organic Carbon and Disinfection Byproducts.....	13-15
12	13.3.5. Total Dissolved Gas (TDG).....	13-15
13	13.4 Summary.....	13-16
14	14.0 Uncertainty Analysis.....	14-1
15	14.1 Error-Propagation Methods.....	14-1
16	14.2 Monte Carlo Simulation.....	14-1
17	14.3 Estimates of Uncertainty in the Yellowstone River Q2K Model.....	14-2
18	14.4 Uncertainty Propagation.....	14-9
19	14.5 Results.....	14-10
20	15.0 Comparisons with Other Nutrient Criteria Methods.....	15-1
21	15.1 Criteria Recommendations from the Literature.....	15-1
22	15.2 Ecoregional Recommendations from EPA.....	15-2
23	15.3 Historical Nutrient-Algae Relationships on the Yellowstone River.....	15-2
24	15.4 Summary of Findings.....	15-4
25	15.5 Expert Elicitation Regarding Findings.....	15-5
26	16.0 Summary.....	16-1
27	17.0 References.....	17-1
28		
29	Appendix A. Quality Assurance Project Plan (QAPP) and Sampling and Analysis Plan (SAP)	
30	Appendix B. Field data forms	
31	Appendix C. Model input and output files	
32	Appendix D. Peer-review forms	
33		
34		

1 FIGURES

1	
2	
3	Figure 1-1. Montana’s proposed approach for large river numeric nutrient criteria development. 1-2
4	Figure 1-2. Hypothetical example of numeric nutrient criteria for total P in a Montana river. 1-5
5	Figure 2-1. Example of nuisance <i>Cladophora spp.</i> growth in the Yellowstone River (August 2006). 2-2
6	Figure 2-2. Light extinction in a Montana river and its lateral extent. 2-4
7	Figure 2-3. Influence of light attenuation on productivity in a Montana River. 2-5
8	Figure 3-1. Plot of mean daily water temperature against algal growth limiting threshold. 3-2
9	Figure 3-2. Plots of daily photon flux density against algal growth limiting threshold. 3-3
10	Figure 3-3. Streamflow hydrology and the critical period for large river criteria development. 3-4
11	Figure 4-1. Yellowstone River area watershed in Montana, Wyoming, and North Dakota. 4-2
12	Figure 4-2. Lower Yellowstone River study area showing monitoring locations and other features. 4-4
13	Figure 4-3. Representative regions of the lower Yellowstone River project site. 4-5
14	Figure 4-4. Mean daily normals for the lower Yellowstone River. 4-6
15	Figure 5-1. Conceptual representation of Q2K (redrawn from Brown and Barnwell, 2004). 5-2
16	Figure 5-2. Diagram of model kinetics and mass transport processes in Q2K. 5-4
17	Figure 5-3. Typical occurrence of thermal and hydrologic stability in the Yellowstone River. 5-7
18	Figure 5-4. Conceptual representation of the AlgaeTransect2K (AT2K) model. 5-8
19	Figure 6-1. Historical nutrient concentrations in the lower Yellowstone River. 6-6
20	Figure 6-2. Dissolved oxygen data on the Yellowstone River for August 1967, 1976, 2000, and 2007. .. 6-7
21	Figure 6-3. Conditions encountered during the 2000 and 2007 field data collection efforts. 6-9
22	Figure 7-1. Longitudinal profile of the Yellowstone River. 7-3
23	Figure 7-2. Surface water summary for the lower Yellowstone River during 2007. 7-4
24	Figure 7-3. Graphical summary of water exchanges in the Yellowstone River during August 2007. 7-10
25	Figure 7-4. Depth and velocity rating curves derived for the lower Yellowstone River. 7-16
26	Figure 7-5. Estimated variation of Manning’s n with flow for the Yellowstone River. 7-19
27	Figure 7-6. Estimated width, depth, and velocity over 1 km increments in the Yellowstone River. 7-20
28	Figure 7-7. Paired wind rose data for the lower Yellowstone River during 2007. 7-22
29	Figure 7-8. Hourly meteorological data summary for lower Yellowstone River in 2007. 7-23
30	Figure 7-9. Mean repeating day climate inputs for lower Yellowstone River Q2K model. 7-24
31	Figure 7-10. Hourly and repeating day cloud cover data for the lower Yellowstone River. 7-25
32	Figure 7-11. Simulated and observed solar radiation for the lower Yellowstone River. 7-26
33	Figure 7-12. CO ₂ data and nitrogen dry deposition by species for the Yellowstone River. 7-27
34	Figure 7-13. Simulated mean daily shade for the Yellowstone River. 7-28
35	Figure 7-14. Comparative water quality inflow plots for the Yellowstone River. 7-29
36	Figure 7-15. Estimated nitrogen contributions to the lower Yellowstone River during 2007. 7-34
37	Figure 7-16. Estimated phosphorus contributions to the lower Yellowstone River during 2007. 7-35
38	Figure 8-1. Longitudinal sensitivities of selected model rates and forcings for DO and pH. 8-4
39	Figure 8-2. Stoichiometric C:N:P regression relationships for the Yellowstone River. 8-7
40	Figure 8-3. Primary productivity and respiration measurements on the Yellowstone River in 2007. 8-8
41	Figure 8-4. Comparison between zero- and first-order maximum unlimited growth estimates. 8-10
42	Figure 8-5. Estimated maximum biomasses with losses but no nutrient or light limitation. 8-11
43	Figure 8-6. Light extinction coefficients calculated for the Yellowstone River. 8-16
44	Figure 8-7. Monthly mean true color measurements for the lower Yellowstone River (1963-1970). 8-17
45	Figure 8-8. ASTM reference spectra used to evaluate the net absorption coefficient for color. 8-18
46	Figure 8-9. Suspended sediment particle size (mm) in Yellowstone River during low-flow conditions. 8-19
47	Figure 8-10. Optimized partial extinction coefficients for the remaining coefficients ($\alpha_i, \alpha_o, \alpha_p$ & α_{pn}). 8-19

1	Figure 9-1. Model calibration and validation approach for the Yellowstone River.....	9-2
2	Figure 9-2. Example of YSI sonde data from the Yellowstone River in 2007.....	9-5
3	Figure 9-3. Evaluating model runtime requirements for the Yellowstone River.....	9-7
4	Figure 10-1. Simulated and observed streamflow for the Yellowstone River during 2007.....	10-2
5	Figure 10-2. Simulated and observed river widths and depths for the Yellowstone River during 2007.....	10-3
6	Figure 10-3. Verification of travel-times for the Yellowstone River during 2007.....	10-4
7	Figure 10-4. Water temperature simulation for the lower Yellowstone River during 2007.	10-6
8	Figure 10-5. TSS and ISS simulations for the lower Yellowstone River during 2007.	10-8
9	Figure 10-6. Detritus simulation for the lower Yellowstone River during 2007.....	10-9
10	Figure 10-7. Total and organic N simulations for the Yellowstone River during 2007.....	10-10
11	Figure 10-8. Dissolved nitrogen simulations for the Yellowstone River during 2007.....	10-12
12	Figure 10-9. Total and organic phosphorus simulations for the Yellowstone River during 2007.....	10-13
13	Figure 10-10. Soluble phosphorus simulations for the Yellowstone River during 2007.....	10-14
14	Figure 10-11. Nutrient and light limitation factors for the Yellowstone River during 2007.....	10-15
15	Figure 10-13. AT2K simulations of lateral algal distribution in Yellowstone River.	10-18
16	Figure 10-13. AT2K simulations of lateral algal distribution in Yellowstone River.	10-19
17	Figure 10-13. AT2K simulations of lateral algal distribution in Yellowstone River.....	10-20
18	Figure 10-15. Benthic algal biomass lateral simulation reliability.	10-22
19	Figure 10-16. Phytoplankton simulations for the Yellowstone River during 2007.....	10-23
20	Figure 10-17. DO simulations for the lower Yellowstone River during 2007.	10-26
21	Figure 10-18. pH simulations for the Yellowstone River during 2007.....	10-28
22	Figure 10-19. Alkalinity simulations for the lower Yellowstone River during 2007.....	10-28
23	Figure 10-20. CBOD-ultimate and TOC simulations for the Yellowstone River during 2007.....	10-30
24	Figure 10-21. Conductivity simulations for the Yellowstone River during 2007.	10-31
25	Figure 11-1. Simulated and observed streamflow for the Yellowstone River during 2000.....	11-5
26	Figure 11-2. Mass transport indicators for the lower Yellowstone River during 2000.....	11-6
27	Figure 11-3. Temperature simulations for the Yellowstone River during 2000.	11-7
28	Figure 11-4. TSS simulations for the Yellowstone River during 2000.	11-8
29	Figure 11-5. Total and organic N simulations for the Yellowstone River during August 2000.....	11-9
30	Figure 11-6. Nitrogen simulations for the Yellowstone River during August 2000.	11-10
31	Figure 11-7. Phosphorus simulation for the Yellowstone River during August 2000.....	11-11
32	Figure 11-8. Nutrient and light limitation factors for the Yellowstone River during 2000.....	11-12
33	Figure 11-9. Algal simulations for the Yellowstone River during August 2000.....	11-13
34	Figure 11-10. Dissolved oxygen simulations for the Yellowstone River during August 2000.....	11-14
35	Figure 11-11. pH, alkalinity, and TOC simulations for the Yellowstone River during 2000.	11-15
36	Figure 11-12. Simulated and observed conductivity for the Yellowstone River during 2000.	11-16
37	Figure 12-2. Estimated time to nuisance algal biomass under moderately enriched conditions.	12-4
38	Figure 12-3. Period of record used in development of low-flow frequency curves for Miles City.....	12-6
39	Figure 12-4. N-day low-flow analysis for Yellowstone River at Miles City (1968-2008).....	12-7
40	Figure 12-5. Log-Pearson Type III low-flow frequency curve for the Yellowstone River at Miles City....	12-9
41	Figure 12-6. Example TMY air temperature plot for 742300 Miles City Municipal Airport.....	12-11
42	Figure 12-7. Plots of adjusted TMY in comparison with August 2007 field data.....	12-12
43	Figure 12-8. Wind Rose data on the lower Yellowstone River.	12-14
44	Figure 13-1. Example of the iterative procedure required to assign headwater boundary conditions. .	13-5
45	Figure 13-2. Consideration of headwater detritus and phytoplankton concentrations.	13-6
46	Figure 13-3. Example of a water quality endpoint determination.	13-9
47	Figure 13-4. Non-linear response relationship between nutrients and pH.....	13-10
48	Figure 13-5. Non-linear response relationship between nutrients and benthic algae.....	13-11

1 Figure 14-1. Example of Monte Carlo simulation procedure for Yellowstone River. 14-2
2 Figure 14-2. Example point load PDF used in Yellowstone River Monte Carlo Analysis. 14-5
3 Figure 14-3. Example PDF assignment for model rate coefficients on the Yellowstone River..... 14-7
4 Figure 14-4. Estimated model output variance around computed criteria..... 14-10
5 Figure 15-1. Level III ecoregions in relation to water quality criteria recommendations. 15-3
6 Figure 15-2. Relationship between nutrients and benthic biomass on the lower Yellowstone River..... 15-4
7
8

1 TABLES

2		
3	Table 1-1. Large or non-wadeable rivers in Montana.....	1-4
4	Table 2-1. Water quality problems associated with nutrient enrichment.	2-1
5	Table 4-1. Long-term climatic stations on the lower Yellowstone River.	4-6
6	Table 4-2. Active streamflow gaging stations on the Yellowstone River.....	4-6
7	Table 4-3. Water-use classification, beneficial uses, and standards for the lower Yellowstone River.	4-7
8	Table 4-4. Waterbody segments proposed for nutrient criteria development.....	4-8
9	Table 5-1. Model state-variables in Q2K.....	5-3
10	Table 5-2. Verification of steady-state flow requirements for QUAL2K.....	5-6
11	Table 6-1. Data sources used in development of the Yellowstone River nutrient model.	6-2
12	Table 6-2. Main-stem water quality stations on the Yellowstone River with sufficient data.	6-3
13	Table 6-4. Data collection matrix for the DEQ 2007 and USGS 2000 monitoring programs.	6-8
14	Table 6-5. Water chemistry comparisons for the DEQ 2007 and USGS 2000 data programs.	6-9
15	Table 6-6. Summary of water quality data during the 2000 and 2007 field data collection efforts.	6-10
16	Table 7-1. Data sources used in the lower Yellowstone River QUAL2K model development.....	7-1
17	Table 7-2. Aerial photography summary of the lower Yellowstone River.....	7-1
18	Table 7-3. Representative flow path lengths of the lower Yellowstone River.	7-2
19	Table 7-4. Magnitude and probability of seasonal low flow for the Yellowstone River.....	7-5
20	Table 7-5. Instantaneous field measurements completed by Montana DEQ during 2007.	7-5
21	Table 7-6. Sites used in estimation of unmonitored tributaries.....	7-6
22	Table 7-7. Municipal discharges in the lower Yellowstone River study reach during 2007.	7-7
23	Table 7-8. Summary of major irrigation units on the lower Yellowstone River.	7-7
24	Table 7-10. Tabular summary of Yellowstone River water balance for August 2007.....	7-11
25	Table 7-11. Tabular summary of Yellowstone River water balance for September 2007.....	7-12
26	Table 7-12. Locations of natural grade controls on the Yellowstone River.....	7-13
27	Table 7-13. Hydraulic property transects within the lower Yellowstone River study reach.	7-14
28	Table 7-14. USGS gage sites having rating measurement data on the Lower Yellowstone River.	7-15
29	Table 7-15. Rating curve exponents derived for the Lower Yellowstone River.....	7-16
30	Table 7-16. Travel-time data and mean streamflow velocities for the Yellowstone River in 2008.....	7-17
31	Table 7-17. Hourly climatic stations and associated mean daily observations.	7-21
32	Table 7-18. Cloud cover classes and associated conversions.	7-25
33	Table 7-19. Dry deposition by nitrogen species estimated for lower Yellowstone River.....	7-27
34	Table 7-20. Riparian landcover types and associated attributes used to estimate shade.	7-28
35	Table 7-21. Unmeasured tributary water quality data summary (1973-2007).	7-32
36	Table 7-22. Irrigation waste-drain water quality data summary (1999-2007).	7-32
37	Table 7-23. Groundwater water quality data summary for the Yellowstone River.	7-33
38	Table 7-24. Probable error range in sample collection, storage, preservation, and analysis.....	7-36
39	Table 8-1. Model sensitivities of the lower Yellowstone River Q2K model for DO, pH, and algae.	8-2
40	Table 8-2. Model sensitivities of the lower Yellowstone River Q2K model for TN and TP.	8-3
41	Table 8-3. Percent frequency of algae taxa occurrence in the Yellowstone River.	8-5
42	Table 8-4. Maximum unlimited first-order benthic algae growth rates from the literature.....	8-9
43	Table 8-5. Estimated reaeration coefficients for the Yellowstone River during 2007.....	8-14
44	Table 8-6. SOD from the Yellowstone River measured via core incubations.	8-14
45	Table 8-7. SOD and algal coverage estimates for Yellowstone River.	8-15
46	Table 8-8. Final optic coefficients for Yellowstone River Q2K model.....	8-20
47	Table 9-1. Recommended relative or standard errors for water quality model simulations.....	9-4

1 Table 8-2. Data used in calibration and validation of Q2K for the lower Yellowstone River.....9-4

2 Table 9-3. Relationship between Q2K state-variables water chemistry collections.9-6

3 Table 9-4. Light and heat parameters used in the Yellowstone River Q2K model.9-9

4 Table 9-5. C:N:P rate coefficients used in the Yellowstone River Q2K model.9-10

5 Table 9-6. Bottom algae Q2K parameterization for the lower Yellowstone River.9-11

6 Table 9-7. Phytoplankton parameter Q2K parameterization for the lower Yellowstone River.9-12

7 Table 10-1. Statistical summary of Q2K model simulations for Yellowstone River.10-1

8 Table 10-2. Comparison of various travel-time estimates for Lower Yellowstone River.10-5

9 Table 12-2. Comparative summary of 15Q10 low-flow analysis for the Lower Yellowstone River..... 12-8

10 Table 12-3. TMY adjustments based on paired station analysis from August 1- September 21, 2007. 12-12

11 Table 12-4. TMY adjustment factors for climatic regions used in the Q2K model.12-13

12 Table 12-5. Low-flow water quality summary for the Yellowstone River.12-15

13 Table 12-6. Diurnal variation in low-flow water quality.12-16

14 Table 12-7. Low-flow conditions on gaged tributaries to the Yellowstone River..... 12-17

15 Table 13-3. Published equations relating phytoplankton Chl a to TP or TN concentration.13-4

16 Table 13-4. Model simulations to evaluate the relationship between TN and waterbody response.13-7

17 Table 13-5. Model simulations to evaluate the relationship between TP and waterbody response.....13-8

18 Table 13-6. Recommended numeric nutrient criteria for the Yellowstone River.13-11

19 Table 14-1. PDF assignments for headwater boundary conditions of the Yellowstone River.14-3

20 Table 14-2. PDF assignments for point loads on the Yellowstone River.14-4

21 Table 14-3. PDF assignments for diffuse loads on the Yellowstone River.14-6

22 Table 14-4. PDF assignments for rate coefficients for the Yellowstone River..... 14-8

23 Table 15-1. Examples of numeric nutrient criteria in the literature..... 15-1

24 Table 15-2. Level III ecoregion ambient water quality criteria recommendations.....15-2

25 Table 15-3. Summary of outcomes from varying approaches to assess numeric nutrient criteria.....15-5

26 Table 15-4. Expert review panel solicited for input regarding Yellowstone River nutrient criteria.15-5

27

28

EXECUTIVE SUMMARY

The development of numeric nutrient criteria for nitrogen (N) and phosphorus (P) is one of many tasks that the Montana Department of Environmental Quality (DEQ) is working on to support our statewide water quality management objective. The intent of these criteria is to protect waterbodies and their associated beneficial uses from eutrophication. Eutrophication, or the enrichment of waters by nutrients, causes a variety of water quality problems in flowing systems including nuisance algal growth, altered aquatic communities, and undesirable water quality changes that impair beneficial uses.

In the mid 2000s DEQ concluded that successful technical approaches for developing numeric nutrient criteria for wadeable streams and small rivers would not be transferable to large rivers. This was due to a number of reasons including: (1) a lack of reference watersheds (i.e., those with little human influence) that could be used to help derive water quality benchmarks, (2) differences in the physical character of large rivers that make them different from wadeable streams (being deeper and more light limited), and (3) generally poor correlations between nutrients and eutrophication response in the scientific literature. Cross-correlations between ambient nutrient concentrations and a variety of different stressors were further considerations.

DEQ opted instead to develop criteria for large rivers using mechanistic water quality models. Such tools have been used for many decades in water quality management and environmental decision support and have shown great value in effluent loading studies, for example. Because water quality models are deterministic and use well-described mathematical relationships among nutrients, light availability, algal uptake, growth, and nutrient recycling, they can be used to proactively manage and understand the physical environment. More importantly they can assist in translating between nutrient concentrations and Montana's existing water quality standards (e.g., dissolved oxygen, pH, algal biomass, etc.). Beneficial uses that DEQ is required to protect as part of existing water quality standards for large rivers are:

- Public water supplies
- Aquatic life, including fish
- Recreational uses
- Agricultural uses
- Industrial uses

Nutrients had previously been addressed in Montana using narrative criteria. These are qualitative statements that describe the desired condition of a waterbody. They are flexible in that they can be adapted to many potential situations (even unforeseen ones), however, because they lack specificity and are open to varied interpretations, their subjectivity is a concern. Adoption of numeric criteria will eliminate this fault and provide readily measurable limits that are easier to monitor, assess, and regulate. Consequently, the criteria outlined in this document closely reflect the spirit and intent of the narrative criteria, but also provide sufficient detail to be of practical value.

Upon embarking on this work DEQ found that very little had been done to advance the science of large river nutrient criteria in the United States. In fact, from our literature review, this is the first documented case where criteria were derived on a large river using a water quality model. As a result, DEQ first decided that the model as well as the data supporting the model should be of research quality. Such a level of rigor would reduce the number of model assumptions and would enhance the defensibility of the proposed criteria determined via the model.

1
2 DEQ's first task was to select an appropriate water quality model and large river segment to model.
3 Several tools were considered. After weighing the pros and cons of each, DEQ selected the enhanced
4 river quality model QUAL2K (Q2K). Key advantages of Q2K included: (1) the ability to simulate the
5 eutrophication variables of interest (such as dissolved oxygen, pH, total organic carbon, bottom-
6 attached algal growth, phytoplankton, etc.), (2) widespread use and national familiarity with the model,
7 (3) relatively modest data requirements, (4) simplicity in model application and development, (5) very
8 good modeling documentation and user support, and (6) endorsement by the U.S. Environmental
9 Protection Agency (EPA). Q2K was found to have been used extensively for water quality regulation
10 including permitting and compliance, waste-load allocations, and total maximum daily loads (TMDLs)
11 throughout the U.S. and abroad.

12
13 The large river we chose to model was the Yellowstone River. It was selected for three key reasons. First,
14 it is unregulated which lends less-complex modeling scenarios. Second, it is arguably one of the most
15 important rivers in the state due to its proximity to a large proportion of Montana's population, the
16 industrial base found along it, and the river's national and international recognition. Finally, it has
17 transitional water quality characteristics (e.g., sharp changes in turbidity) that help us better understand
18 lotic water quality mechanics. The specific study reach was in the lower part of the river between
19 Forsyth to Glendive, MT. It is 232.9 km (144.7 mi) long and part of the Great Plains ecoregion.

20
21 In 2006, a reconnaissance was completed to confirm that a one-dimensional model such as Q2K was
22 appropriate for use on the Yellowstone River. By evaluating vertical and lateral water quality gradients
23 at several locations along the project reach, we determined that it was aptly sufficient. We also
24 identified a suitable time-frame for data collection and modeling. A period of stability occurs from early
25 August to late September when conditions are approximately steady-state (i.e., water temperature,
26 light, and hydrology are fairly stable). As such, assumptions and limitations implicitly required in the use
27 of the model were achieved.

28
29 We then launched a major data collection effort during the summer of 2007 to support development of
30 the model. River surveys were completed throughout the summer and included continuous monitoring
31 of dissolved oxygen, temperature, conductivity, pH, and chlorophyll *a* (8 sites), water chemistry
32 monitoring (2 times), measurement of bottom-attached (benthic) algae and free-floating algae
33 (phytoplankton), characterization of quality and quantity from incoming tributaries and wastewater
34 facilities, and much more. One sampling episode was completed in August to calibrate the model, and a
35 second was undertaken in September for validation. DEQ also cooperated with the U.S. Geological
36 Survey (USGS) during 2008 on a dye-tracer time of travel study to provide information for the physical
37 structure of the model. Locations were optimized through the monitoring to ensure that the
38 requirements of Q2K were met.

39
40 To our fortune, the data collection took place during a relatively low-flow year. In fact, it was the 7th
41 ranked seasonal low-flow on record, between a 10 to 20 year recurrence-interval. Hence conditions
42 were very close to design requirements for nutrient criteria. Additionally, because eutrophication
43 problems are exacerbated at low flows [such as those used in National Pollutant Discharge Elimination
44 System (NPDES) permits] the timing of the data collection could not have been more ideal. Perhaps
45 most interesting, though, was that despite low-flow conditions we saw no signs of water quality
46 impairment in the river during 2007. It can therefore be inferred that nutrient concentrations higher
47 than 2007 would be necessary to drive nutrient impairment. In 2007 they were $\approx 500 \mu\text{g}$ total nitrogen

1 (TN) L⁻¹ and ≈50 µg total phosphorus (TP) L⁻¹. Assimilative capacity therefore still exists in regard to
2 nutrient loads in the lower Yellowstone River.

3
4 We augmented our data collection program with information from other agencies. For example,
5 climate, bathymetry, and atmospheric information were taken from the National Weather Service, the
6 Yellowstone River Conservation District Council, and EPA. A great deal of related information was
7 obtained from past water quality studies, algal growth experiments, and peer-reviewed literature. In
8 examination of this material we determined that the Yellowstone River, despite being classified as a
9 large river, would likely be strongly influenced by benthic algae. Hence we spent considerable time
10 ensuring that model relationships related to benthic algae were consistent with prior research. We also
11 collaborated on a new module, AlgaeTransect2K (AT2K), which assisted in our assessment of the river.

12
13 AT2K, unlike Q2K, has the ability to simulate lateral benthic algae growth and biomass accrual across a
14 river transect. This gave DEQ the ability to assess the lateral effect of nutrients on large rivers by
15 integrating depth, light, and near-shore channel geomorphology into river management. The
16 importance of such a tool is highlighted by the fact that human use and perception is often inclined
17 toward the near-shore or wadeable regions where beneficial use is first initiated. AT2K is suited best to
18 simulating algal growth that is closely attached to the bottom, like diatoms and short filaments of green
19 algae, whereas its ability to simulate long streamers of attached filamentous algae that exist in the three
20 dimensions of the water column is more limited.

21
22 We then set about developing the Q2K model for the Yellowstone River. Standard scientific and
23 engineering principles were used in construction, calibration, and confirmation of the model. Analysis
24 was completed until acceptable agreement was found between observed and simulated state-variables.
25 Of those available to us, we relied heavily on DO, pH, total nutrients, and benthic-algae. These were
26 some of our best field measurements. Relative error and root mean squared error statistics were
27 quantified to assess model prediction efficiency, and after rigorous testing, we were satisfied with the
28 calibration. It met both the criteria specified in the project's 2006 quality assurance project plan as well
29 as other criteria from the scientific literature. Upon validation however, we found that our calibrated
30 model was not suitable for simulating late-season conditions (i.e., our September data collection event).

31
32 Consequently, we used two additional approaches to explore the differences between the calibration
33 and validation. First, we closely examined the river's biological conditions as indicated by diatom algae
34 which were collected in 2007 as part of the project. Life history and ecological requirements of these
35 producers have been extensively studied and provided an independent means of assessing river
36 conditions. Analysis suggested that the river was different in September than in August for a number of
37 plausible reasons, including differences in diatom communities (a shift from more to less productive
38 taxa), apparent changes of the benthic algae matrix (less *Cladophora* that provide a 3-dimensional
39 environment for diatoms to colonize), and possible temperature and photoperiod-induced senescence.
40 We were able to reproduce these changes in the model by adjustment of benthic algal related growth
41 parameters.

42
43 We also completed a second independent validation of the original calibration (i.e., August 2007) to
44 address any concerns with the initial validation. A data set collected by USGS in August of 2000 (9th
45 lowest seasonal low-flow of the record) was used in this second attempt. Given that their data was from
46 a different set of climatic and nutrient conditions (but similar low-flows), this was a robust test of the
47 model to see if it could simulate a period outside of when the model was calibrated. The model was also
48 extended to a much longer reach (Billings to Sidney, MT) to accommodate additional data. In this

1 instance, the validation was successful and we believe it to be an even more rigorous test than the first
2 given that the calibrated rates cover a much larger spatial area than previously attempted. Hence DEQ is
3 very satisfied with the quality of the final calibrated and validated model.

4
5 DEQ then set about the process of deriving N and P nutrient criteria with the model. This required
6 several initial decisions including: (1) which design flow to use, (2) climatic conditions associated with
7 that design flow, and (3) what (if any) alterations to the model's headwater boundary conditions should
8 be made to account for future changes in upstream water quality (i.e., as the river moves closer to the
9 nutrient criteria over time). To determine the first constraint, we used algal growth rates as an indicator
10 of the response time to reach nuisance algal levels. By assuming that a waterbody will respond
11 biologically before any adverse water column conditions develop (such as DO or pH impairment), an
12 appropriate design flow should be established that will constrain the concentration of nutrients over a
13 duration that will limit such biologically-based excursions. The frequency of the occurrence must also
14 allow for sufficient recovery time, as indicated in EPA guidance.

15
16 By using literature based first-order net specific growth rates, we concluded that algae can reach
17 nuisance levels in approximately 14 days under moderately enriched conditions. Subsequently, we
18 recommend a design flow duration of 14-days (or the seasonal 14Q10) for setting nutrient limits on
19 large rivers. Any nutrient control policy must achieve ambient water quality conditions conducive to this
20 flow. Our recommendation is different than currently provided by EPA (i.e., they suggest a 7-day 10-year
21 low flow [7Q10]), however, we feel it is better suited toward nutrients than toxics for which the 7Q10
22 was originally intended. The proposed design flow is also consistent with widely reported USGS low-flow
23 statistics for streams and rivers throughout the U.S. (including Montana). This will make design for
24 design flows that are easy to identify and apply for future criteria and permitting work. Finally, the 10-
25 year frequency was left unaltered due to prior national precedent thereby leaving ample time for the
26 river to recover after an excursion.

27
28 DEQ then used a typical meteorological year (TMY) as the design climate. These data (developed by the
29 National Renewable Energy Laboratory) provided an unbiased set of conditions for a given location over
30 a long period of time, such as 30 years. We chose the most probable period during which the 14-day
31 seasonal low-flow would occur, which was the third week of August. Since the TMY is an annual event
32 (i.e., it could happen every year), it is well-suited for criteria development work as it does not alter the
33 underlying probability of occurrence (i.e., still a 10-year event). In other words, DEQ did not select a low-
34 flow and then couple it with the worst possible weather scenario. Rather, we selected an appropriate
35 low-flow and then applied it to the expected annual mid-summer climate.

36
37 In parallel with the low-flow data analysis, we also evaluated historical water quality data for said low-
38 flow conditions. Data from the ten lowest 14Q10 low-flow years on record (1988, 1994, 2000, 2001,
39 2002, 2003, 2004, 2005, 2006, and 2007) were available thanks to USGS sampling over the years. Central
40 tendencies of this data were used to estimate water quality conditions and associated loads for our
41 scenario analysis. A similar procedure was done for the point loads (tributaries, WWTPs, etc.). From
42 review of this information nutrient concentrations appeared to be lower than would typically impair
43 water quality. Consequently nutrient standards should be set higher (i.e., have a greater concentration
44 than) existing conditions.

45
46 We then carried out a series of controlled nitrogen and phosphorus additions in Q2K to identify nutrient
47 levels that would impair water quality (e.g., pH, DO, benthic algae levels, etc.). To do this, incremental
48 increases in soluble nutrient concentrations were evaluated in the model until a limiting response was

1 achieved. Two types of model runs were considered, one where soluble nitrogen was in limited supply
2 and soluble phosphorus was unlimited, and the other where phosphorus was limiting and nitrogen was
3 in unlimited supply. Each was necessary since only one nutrient can limit algal growth in the model at
4 any time. Ten different model runs were carried out for each limiting nutrient under different degrees of
5 nutrient limitation where the response for each state-variable of interest was recorded and compared
6 with existing water quality standards.

7
8 Through these model runs it was determined that our upstream boundary condition would inevitably be
9 altered over time as the river approaches the proposed criteria. We estimated these changes using
10 published phytoplankton-nutrient relationships and resolved other related parameters, such as algal
11 detritus and dissolved organic carbon, through iterative adjustment of boundary conditions until
12 longitudinal stability was achieved near the upper end of the model. Total nutrient concentrations were
13 of primary interest in this fine-tuning given their greater correlation with other water quality
14 parameters, ease of monitoring, and EPA expectations.

15
16 Accordingly, we evaluated simulation endpoints such as DO minima, pH flux, benthic algae biomass,
17 total dissolved gas, total organic carbon, etc. The highest total N or P concentration that did not elicit a
18 limiting water quality response was used to determine the effective nutrient criteria (at a point just
19 below where the harmful change occurred). In the upper portion of the study reach (between Forsyth
20 and the Powder River confluence), pH was found to be most limiting and crept increasingly upward until
21 the induced change was greater than Montana's water quality standard of 0.5 units of pH flux at a pH
22 over 9.0 standard units. This threshold is protective of aquatic life and warm water fish and should not
23 be exceeded.

24
25 In the lower river (Powder River confluence to Glendive) benthic algae biomasses were most limiting.
26 Use impairment occurred when the mean biomass of the wadeable region reached a threshold of 150
27 mg m^{-2} , a value known to impact recreational use. Both AT2K and Q2K were crucial in making this
28 determination. Natural turbidity was the main factor in the change in nutrient sensitivity between the
29 upper and lower river; water clarity declined longitudinally due to fine clay particles in suspension which
30 were mainly input from the aptly-named Powder River.

31
32 DEQ is therefore recommending separate numeric nutrient criteria for each reach to divide the river into
33 practical units for water quality management. Suggested criteria for each reach extend somewhat up-
34 and downstream of the modeled area and are:

- 35
36
- 700 $\mu\text{g TN L}^{-1}$ and 90 $\mu\text{g TP L}^{-1}$ from the Big Horn River confluence to Powder River confluence
 - 1,000 $\mu\text{g TN L}^{-1}$ and 140 $\mu\text{g TP L}^{-1}$ from the Powder River confluence to the state-line
- 37
38

39 It should be noted that the specificity of the model to locale and flow and climate make these estimates
40 applicable to the lower Yellowstone River only during late summer peak productivity. High flows, late fall
41 conditions, or any other consideration outside this realm would preclude these recommendations.
42 Readers should also note that two additional Yellowstone River criteria units were identified for future
43 study. These extend from the Wyoming state line (headwaters) to the Laurel public water supply (PWS),
44 and from the Laurel PWS to the Bighorn River. Field data collection has been scheduled for summer
45 2012 for each of these units.

46
47 We quantified prediction error surrounding our criteria estimate through several methods, most notably
48 uncertainty analysis. Monte Carlo simulations were used to evaluate cumulative parameter and load

1 uncertainty, which at the 90% confidence level was quite low. In fact, output variance was unexpectedly
2 small. This is attributed to several factors including our decision to not perturbate nutrient loads in the
3 analysis (i.e., they had already been adjusted in the nutrient addition scenarios), the fact that rate
4 uncertainties are less important to total nutrients than they are to specific soluble nutrient compounds,
5 and finally that Bayesian inference techniques were used to narrow the range of allowable rate
6 distributions from the broader literature array. Consequently, even under worst case conditions we
7 believe the proposed criteria to be 700 ± 13 and $1,000 \pm 37 \mu\text{g TN L}^{-1}$ and 90 ± 2 and $140 \pm 5 \mu\text{g TP L}^{-1}$ in
8 each criteria unit. Values reflect the mean deviation of possible Monte Carlo outcomes.

9
10 Finally, we evaluated our nutrient criteria against other studies from the scientific literature. Overall
11 they compared favorably and, if anything, inclined toward the higher reported concentrations. This was
12 expected given the known extent of depth and light limitation in the river. Likewise, the modeled
13 response exhibited a typical non-linear form. Generally there was an initial phase where water quality
14 changed linearly with each incremental increase in nutrients, an inflection point where this change
15 subsided, and then a less responsive phase where additional nutrients altered water quality only slightly.
16 Consequently, thresholds exist where the river is at first quite sensitive to nutrient pollution and then
17 that sensitivity declines thereafter. Such knowledge will be helpful in proactively managing them to
18 maintain high quality waters.

19
20 Lastly, we will conclude with a few remarks about the effectiveness of using models for criteria
21 development. The greatest benefit encountered in this study was the added ability to directly quantify
22 the relationship between nutrients and eutrophication response using the model. Complex interactions
23 between light, algal assimilation and growth, and nutrient recycling were all much clearer after
24 application of the model than before. Subsequently we were able to use mathematics to determine the
25 nutrient response of the Yellowstone River in a non-subjective and analytical way. Several noteworthy
26 things were identified specific to large rivers and models.

27
28 First, the eutrophication response is reach-specific and can be buffered through a number of
29 mechanisms. In the Yellowstone River, longitudinal changes in turbidity and depth were most important
30 and required multiple criteria to address localized factors. Second, lateral variation in biological
31 response was important and localized regions of high productivity necessitate that nutrient
32 management plans protect not only the water column, but also specific regions of the river amenable to
33 recreation. Finally, without modeling, this understanding would be difficult if not impossible to
34 understand. Consequently, we feel there is good merit for the use of modeling tools in future large river
35 criteria applications. We owe a great deal of our understanding of the Yellowstone River's patterns to
36 the model, and recommend models as a suitable alternative for other States or Tribes to use for
37 developing numeric nutrient standards.

1 **ACKNOWLEDGEMENTS**

2
3 Recognition should be given to the citizens and taxpayers of Montana. Without their commitment to
4 water quality, this endeavor would not have been possible. The Nutrient Work Group should also be
5 thanked. They were a diverse group of stakeholders who afforded us a resonant sounding board for
6 critical project review. Many DEQ staff contributed to the project. Included were (in alphabetical order):
7 Mark Bostrom, Bob Bukantis, Jonathan Drygas, Erik Makus, Al Nixon, Michael Pipp, Rosie Sada, Mike
8 Stermitz, and Andy Welch. Their work is a credit to the agency. Special thanks must also go to Dr. Steve
9 Chapra at Tufts University. His review of modeling work, hours of collaboration, and constructive
10 criticism were a great benefit to the overall integrity of the project. Finally, a number of other
11 organizations also cooperated. They are listed below and their efforts were greatly appreciated:
12

- 13 • Army Corps of Engineers
- 14 • Buffalo Rapids Irrigation District
- 15 • Bureau of Reclamation
- 16 • City of Miles City
- 17 • City of Forsyth
- 18 • USDA Ft. Keogh Agricultural Experiment Station
- 19 • Montana Bureau of Mines and Geology
- 20 • Montana Department of Natural Resources and Conservation
- 21 • Academy of Natural Sciences of Philadelphia
- 22 • U.S. Geological Survey
- 23 • Yellowstone River Technical Advisory Committee of the Yellowstone River Conservation District
24 Council

25
26 Work on this effort was completed cooperatively by the Water Quality Standards and Water Quality
27 Modeling sections of DEQ in support of the Montana water quality standards program.
28
29

1 ACRONYMS

2

Acronym	Definition
7Q10	7-Day 10-Year Low-flow Condition
15Q10	15-Day 10-Year-Lowflow Condition
ACOE	Army Corps of Engineers
AFDM	Ash Free Dry Mass
APT	Airport
ARM	Administrative Rules of Montana
ASABE	American Society of Agriculture and Biological Engineers
ASTM	American Society of Testing and Materials
AT2K	Algae Transect2K
BAL	Benthic Algae
BMP	Best Management Practices
BOD	Biochemical Oxygen Demand
BOR	Bureau of Reclamation
BRGM	Bureau of Reclamation Buffalo Rapids Glendive AgriMet Station
BRID	Buffalo Rapids Irrigation District
BRTM	Bureau of Reclamation Buffalo Rapids Terry AgriMet station
CBOD	Carbonaceous Biochemical Oxygen Demand
CCC	Criteria Continuous Concentrations
CDF	Cumulative Density Functions
CFR	Code of Federal Regulations
CI	Confidence Interval
COV	Coefficient of Variation
C _T	Total Inorganic Carbon
CWA	Clean Water Act
DBP	Disinfection By-products
DEM	Digital Elevation Model
DEQ	Department of Environmental Quality (Montana)
DMR	Discharge Monitoring Report
DNRC	Department of Natural Resources & Conservation
DO	Dissolved Oxygen
DOC	Dissolved Organic Carbon
DS	Downstream
DVT	Diversion
EPA	Environmental Protection Agency (US)
EQIP	Environmental Quality Initiatives Program
ET	Evapotranspiration
EWI	Equal width integrated
FAS	Fishing Access Site
FBOD	Fast CBOD
FWS	Fish & Wildlife Service (US)
GIS	Geographic Information System
GWIC	Groundwater Information Center
ICIC	Integrated Compliance Information System
ICIS	Integrated Compliance Information System

Acronym	Definition
IR	Integrated Report
ISS	Inorganic Suspended Solids
LIDAR	Light Detection and Ranging
MBMG	Montana Bureau of Mines and Geology
MCA	Montana Codes Annotated
MCS	Monte Carlo Simulation
MDOT	Montana Department of Transportation
MDT	Montana Department of Transportation
MPDES	Montana Pollutant Discharge Elimination System
MSU	Montana State University
NAIP	National Agriculture Imagery Program
NAWQA	National Water Quality Assessment Program
NB	Nuisance Biomass
NCDC	National Climatic Data Center
NLCD	National Land Cover Dataset
NPDES	National Pollutant Discharge Elimination System
NPS	Nonpoint Source
NRCS	National Resources Conservation Service
NREL	National Renewable Energy Laboratory
NRIS	Natural Resource Information System (Montana)
NTR	National Toxic Rule
NTU	Nephelometric Turbidity Units
NWIS	National Water Information System
NWS	National Weather Service
PANS	Philadelphia Academy of Natural Sciences
PB	Peak Biomass
PDF	Probability Density Function
PFD	Photon Flux Density
PHYT	Phytoplankton
POC	Particulate Organic Carbon
PORG	Organic Phosphorus
PWS	Public Water System (or Supply)
QA	Quality Assurance
QAPP	Quality Assurance Project Plan
RE	Relative Error
RMSE	Root Mean Squared Error
RWIS	Road Weather Information System
SAP	Sampling and Analysis Plan
SC	Sensitivity Coefficient
SCE	Shuffled-complex Evolution
SIN	Soluble Inorganic Nitrogen
SOD	Sediment Oxygen Demand
SRP	Soluble Reactive Phosphorus
SSC	Suspended Sediment Concentration
STORET	EPA STORage and RETrieval database
SWSTAT	Surface Water Statistics Software
TDG	Total Dissolved Gas

Acronym	Definition
TDS	Total Dissolved Solids
TMDL	Total Maximum Daily Load
TMY	Typical Meteorological Year
TN	Total Nitrogen
T _{NB}	Time to Nuisance Biomass
TOC	Total Organic Carbon
TP	Total Phosphorus
T _{PB}	Time to Peak Biomass
TSS	Total Suspended Solids
USDA	United States Department of Agriculture
USGS	United States Geological Survey
VBA	Visual Basic for Applications
VNRP	Voluntary Nutrient Reduction Program
VSS	Volatile Suspended Solids
WDM	Watershed Data Management
WRS	Water Resource Surveys
WTP	Water Treatment Plant
WWTP	Waste Water Treatment Plant

1

2

1 CONVERSION FACTORS

2

3 Length

4 1 centimeter (cm) = 0.394 inches (in)

5 1 meter (m) = 3.2808 feet (ft)

6 1 mile (mi) = 1.609 kilometer (km)

7

8 Area9 1 square kilometer (km²) = 0.386 mi²10 1 hectare (ha) = 10,000 m²

11

12 Volume13 1 cubic meter (m³) = 35.313 cubic feet (ft³)14 1 cubic meter (m³) = 1,000 liters

15

16 Velocity17 1 meter per second (m s⁻¹) = 3.2808 feet per second (ft s⁻¹)

18

19 Mass

20 1 kilogram (kg) = 2.2046 pounds (lb)

21

22 Concentration23 1 mg L⁻¹ = 1,000 µg L⁻¹

24

25 Heat26 1 langley per day (ly d⁻¹) = 1 cal cm⁻² d⁻¹

27

28 Temperature

29 Degrees Celcius (°C) = 5/9 *(Fahrenheit -32)

30

31

32

1.0 INTRODUCTION

Detailed field studies and associated modeling were conducted on a 232.9 km (144.7 mile) segment of the lower Yellowstone River in eastern Montana, extending from Forsyth to Glendive, MT, to assess the feasibility of developing large river numeric nutrient criteria using a mechanistic water-quality model. Specifically, the one-dimensional QUAL2K model (Q2K) and a new model, AlgaeTransect2K (AT2K), were applied in conjunction with literature based approaches to derive nutrient concentrations capable of attaining and maintaining the river's beneficial uses. Goals and objectives of the study were as follows: (1) to assess whether numeric models are appropriate for numeric nutrient criteria development in large river settings, (2) to establish whether modeled criteria are consistent with other nutrient endpoint techniques, and (3) report our findings such that other States or Tribes can make informed decisions about these techniques for large rivers in their regions. Pending success, the methodology could then be transferred elsewhere.

This document describes the outcome of the above approach for the lower Yellowstone River between Forsyth and Glendive, MT (Waterbody IDs MT42K001_010 and MT42M001_012). Details on the project background, data compilation and assessment, materials and methods, model development, results and discussion, and critical low-flow simulations are described herein.

1.1 Background of Numeric Nutrient Criteria Development in Montana

Eutrophication (i.e., from excess nitrogen and phosphorus enrichment) has been a major water quality problem in the U.S. and abroad for many years (Smith, et al., 1999; EPA, 2000b). This is well illustrated by the fact that the U.S. Environmental Protection Agency (EPA) initiated a national eutrophication survey of streams just shortly after its creation in the early 1970s (Omernik, 1977). Regulatory approaches for the control of water pollution had been in place since 1948 (through the Federal Water Pollution Control Act; Pub. L. No. 80-845, 62 Stat. 1155) (Andreen, 2004), however requirements for nutrients were only later addressed in 1972 through the Federal Water Pollution Control Act (33 U.S.C. §1251 et seq., 40 CFR). Better known as the Clean Water Act (CWA), legislative controls were finally provided that would guard our nation's waters against eutrophication and assure that they remain fishable and swimmable (i.e., encompassing recreation and all other beneficial uses).

The Montana Department of Environmental Quality (DEQ) is the delegated federal authority required to implement and enforce CWA regulations within our state. While there are many CWA provisions (far beyond the scope of this document), this document specifically addresses Section 304(a). As required therein, states must identify ambient water quality criteria recommendations for their waters to limit impairments, including impairments from excess nutrients. DEQ currently uses narrative criteria, which aim to limit nuisance conditions through codified statements that describe a desired condition. More recently, we have been requested to provide numeric quantification of these limits (EPA, 1998). Guidance was given by EPA to implement this mandate (EPA, 2000b), and flexibility was allowed to first outline a proposed approach and schedule. It was accompanied by regionally-based interim criteria (EPA, 2000a) that we feel are much too generalized for large rivers and simply are not defensible.

DEQ first submitted a nutrient criteria development plan to EPA in 2002. Since then, we have made good progress in developing numeric nutrient criteria for wadeable streams and small rivers by integrating stressor-response and reference-based approaches (Suplee, et al., 2007). We are only one of 14 states to have done so (EPA, 2008a). Defensible approaches for large rivers are also necessary, but not well

1 established (Smith and Tran, 2010; Weigel and Robertson, 2007). Consequently, we propose a modeling
 2 approach for large rivers that will benefit future efforts. Our intent is to explore the proposed
 3 methodology, develop criteria if appropriate, and better address the state-wide and national deficiency
 4 in large river numeric nutrient criteria development techniques.

6 **1.2 Mechanistic Models & Montana’s Proposed Large River Approach**

8 Montana’s proposed approach for large river numeric nutrient criteria development is shown in **Figure**
 9 **1-1**. It includes sequentially: (1) identification and selection of an appropriate water quality modeling
 10 tool to use in large river settings, (2) data collection to support this tool, (3) application of the chosen
 11 model to a site-specific river reach, (4) subsequent evaluation of critical nutrient concentrations that
 12 impair beneficial uses in the model, (5) model reliability and uncertainty analysis, (6) literature and peer
 13 review of the findings, and (7) criteria establishment.

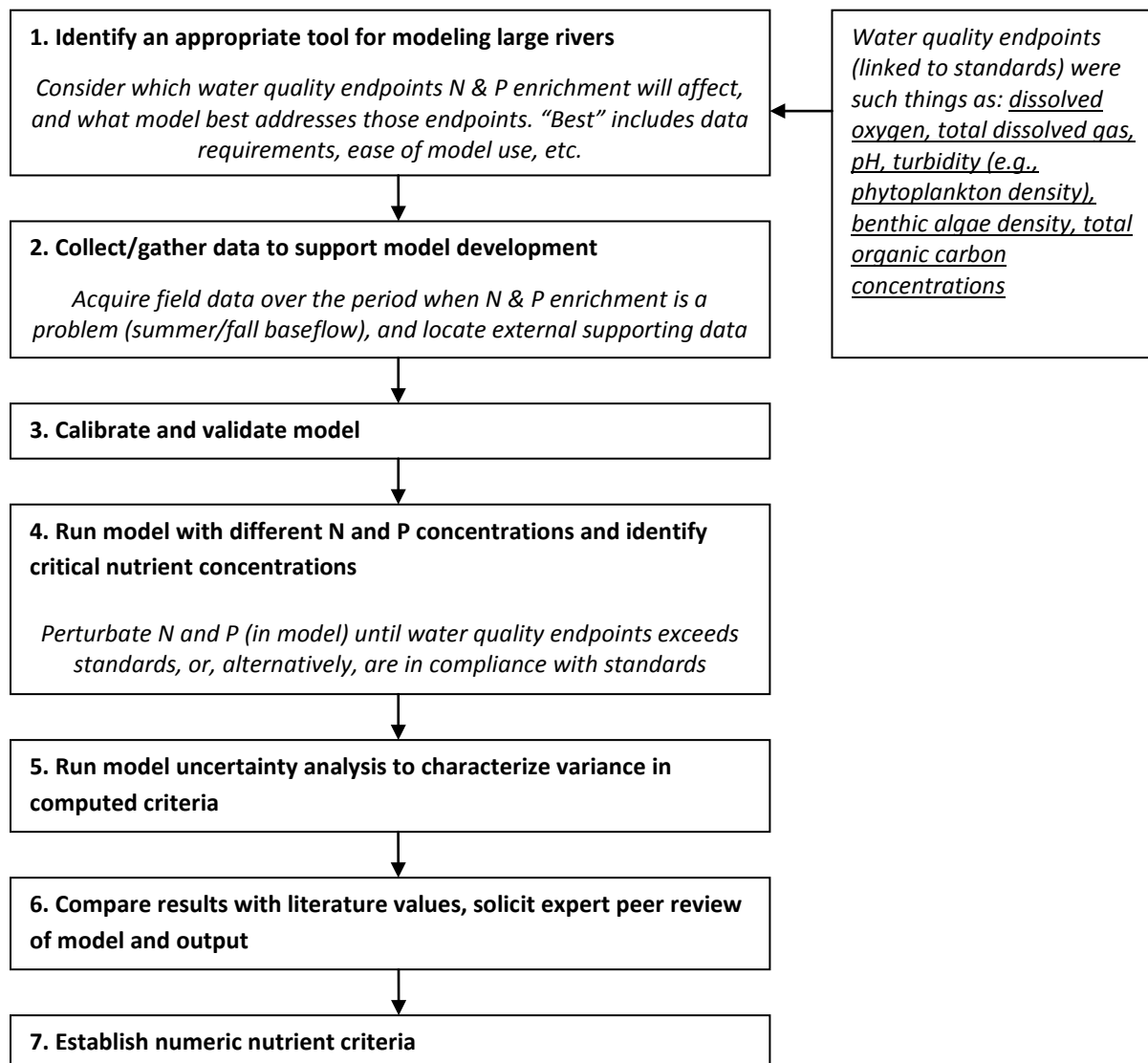

15
16
17 **Figure 1-1. Montana’s proposed approach for large river numeric nutrient criteria development.**

1 Our large river approach is very similar to EPA (2000b), however, it relies heavily on modeling due to a
2 number of limitations inherent in the EPA approach. These include, but are not limited to: lack of
3 suitable populations required for establishing benchmarks via reference-based approaches, poor
4 empirical correlations between ambient nutrient concentrations and algal responses, cross-correlations
5 between different stressors, and limited information on algal and associated biological effects.
6

7 The rationale for model development is not to have a “black box” from which nutrient criteria are
8 mysteriously manufactured. Rather it is to help us more thoroughly understand the linkages between
9 nutrients (cause) and eutrophication (effect), and then relate those responses to beneficial use
10 attainment or non-attainment. Finally we wish to use this knowledge to better complete river water
11 quality management. Our approach therefore is of good intent, robust, and absent of many of the
12 criticisms of the EPA approach identified by others (Hall, et al., 2009).
13

14 **1.3 Why Use a Water Quality Model**

15
16 One might ask why we are proposing a water quality model if other methods already exist to quantify
17 nutrient limits (e.g., empirical approaches). We have already addressed this to some extent, but to
18 reinforce the Department position, other methods are too regionalized or rely too much on scarce
19 reference-river datasets, historical or current impacts of anthropogenic stresses, or poorly transferrable
20 empirical relationships between nutrient concentrations and biota to be practical for water quality
21 management in Montana [similar to that pointed out by Weigel and Robertson (2007)]. Process-based
22 models present a suitable alternative as they use well-established physical relationships between
23 nutrient availability and algal uptake kinetics, other site-specific dependencies such as light, streamflow,
24 temperature, etc., and can be used to elicit tangible relationships between nutrient concentrations and
25 biological or water quality responses. They are well suited to analytical determinations, and are
26 particularly useful in large river settings where complex relationships might otherwise be difficult to
27 ascertain due to confounding environmental factors. Mechanistic models also require less data
28 collection than empirical methods (because the field and laboratory work has already been done to
29 establish the model theoretical construct) and can be used outside of the conditions for which the
30 model was originally developed, making them instructive for deterministic or predictive calculations.
31

32 Consequently, there are numerous advantages of our proposed methodology. Perhaps nearly 85 years
33 of application in water quality management and environmental decision support is justification enough
34 (Chapra, 2003; Thomann, 1998). The fact that many regulatory managers, permit writers, wasteload
35 investigators, and total maximum daily load (TMDL) planners rely on models is further affirmation.
36 Finally and most recently, the role of mechanistic models in criteria development has been detailed in
37 the literature (Carleton, et al., 2005; Carleton, et al., 2009; Reckhow, et al., 2005). Our approach for the
38 Montana water quality standards program is, then, of great benefit for both local and national
39 audiences.
40

41 **1.4 Large River Definition and Scope**

42
43 DEQ defines a large river as one that is unwadeable during the summer and early fall baseflow period.
44 Essentially all rivers in the state that meet this large river definition will be considered for criteria
45 development via modeling. Techniques to distinguish whether a river is wadeable or non-wadeable, as
46 well as what constitutes the baseflow period, have been outlined by Flynn and Suplee (2010). Eight
47 rivers under management by DEQ are non-wadeable (or large) based on the relationship between their

1 wadeability index and baseflow annual discharge¹. These include the Bighorn, Clark Fork, Flathead,
2 Kootenai, Madison, Missouri, South Fork of the Flathead, and Yellowstone rivers (**Table 1-1**).
3

Table 1-1. Large or non-wadeable rivers in Montana.

River Name	Segment Description
Big Horn River	Yellowtail Dam to mouth
Clark Fork River	Bitterroot River to state-line
Flathead River	Origin to mouth
Kootenai River	Libby Dam to state-line
Madison River	Madison Dam to mouth
Missouri River	Origin to state-line
S F Flathead River	Hungry Horse Dam to mouth
Yellowstone River	State-line to state-line

4
5 Since the Yellowstone is the most prominent of these and is non-wadeable from state-line to state-line,
6 it was a good candidate for our water quality model based criteria approach. Its length is a drawback
7 though, as it necessitates that multiple criteria be developed over its extent due to longitudinal changes
8 in eutrophication response (e.g., from shifts in streamflow, temperature, light, etc.). Consequently, we
9 chose to develop criteria on a segment or case-by-case basis. This will be done until either a sufficient
10 understanding of behavioral response of nutrients in large rivers can be understood, or until available
11 data can be pooled such that reasonable conclusions can be made. We consider two segments of the
12 lower Yellowstone River in this work. Further detail on these segments can be found in **Section 4.0**.
13

14 **1.5 Beneficial Uses of Montana Rivers and How Criteria Protect Them**

15
16 Beneficial uses enumerate the societal or ecological characteristics that directly or indirectly contribute
17 to human welfare (17.30.601-17.30.646 (1999); Biggs, 2000b; Stevenson, et al., 1996). In Montana, such
18 uses are defined by the Administrative Rules of Montana (ARM) and for large rivers (use class B-1, B-2,
19 or B-3) include the following activities: (1) drinking, culinary, or food processing purposes (after
20 conventional treatment); (2) bathing, swimming and recreation; (3) propagation of salmonid or non-
21 salmonid fishes (depending on water use class) plus support of other aquatic life, waterfowl, and
22 furbearers; and (4) agricultural and industrial water supply (17.30.601-17.30.646 (1999)). Because rivers
23 must be exploited for societal use (Benke and Cushing, 2005), nutrient criteria (or standards) are the
24 regulatory limits that ensure the waterbody is not harmed beyond acceptable limits.
25

26 A hypothetical example of criteria is presented in **Figure 1-2**. If total phosphorus (TP) concentrations of
27 0.03 mg L⁻¹ are needed to protect recreational uses from nuisance algae (i.e., during the growing
28 season), we see that a criteria exceedance (or excursion) was caused by a waste water treatment plant
29 (WWTP) pulse load during the summer of 1993. The rest of the summer, criteria were met. Simply

¹ Wadeability thresholds were identified from a compilation of 54 different rivers and 157 sites. A baseflow annual discharge of 1,500 ft³ s⁻¹ (42.5 m³ s⁻¹), depth of 3.15 ft (0.96 m), or wadeability index of 7.24 ft² s⁻¹ (0.67 m² s⁻¹) constitutes a non-wadeable river segment.

1 stated, anything below the criteria is protective of the use and anything above it is indicative of
 2 impairment.

3
 4 By default then, criteria then are designed to measure beneficial use attainment. Consequently, they
 5 should be well articulated, good predictors of an anticipated water quality condition, and easy to
 6 measure (Reckhow, et al., 2005). We intend on addressing each of these requirements for the criteria
 7 determination on the Yellowstone River.

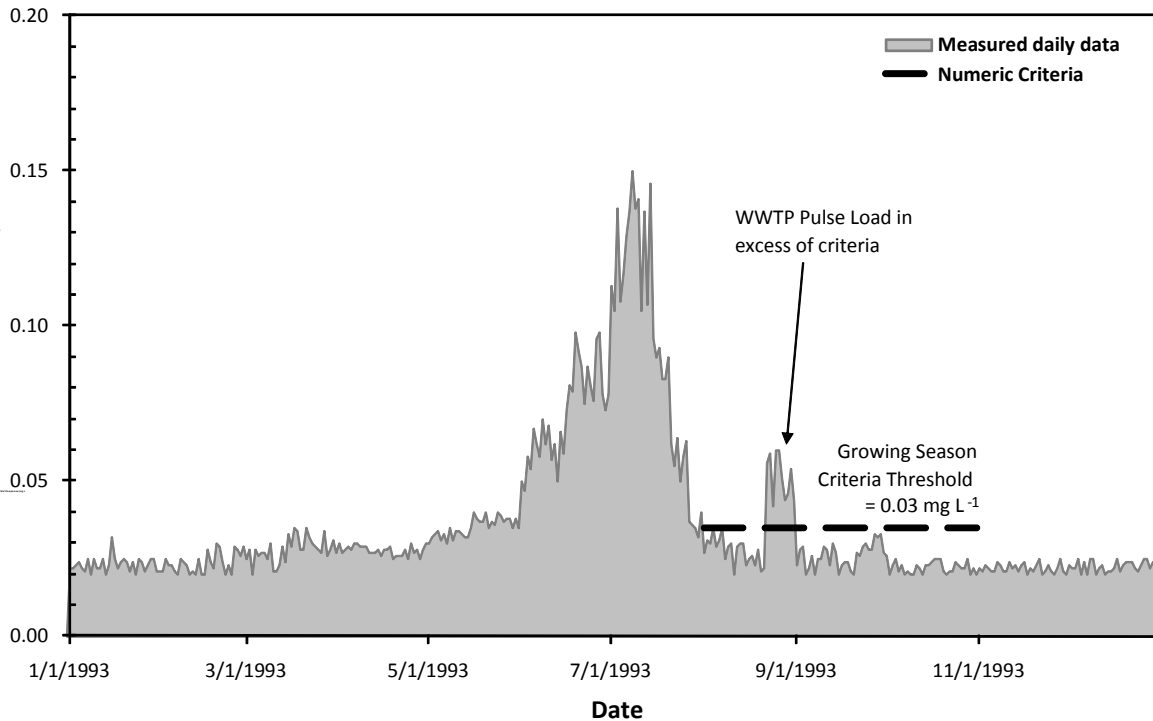

8
 9 **Figure 1-2. Hypothetical example of numeric nutrient criteria for total P in a Montana river.**
 10 Nutrient levels in excess of the proposed criteria are indicative of beneficial use impairment. Concentrations below
 11 the criteria would support their intended uses. This hypothetical example illustrates probable impairment due to a
 12 WWTP pulse load.

14 1.6 Document Outline

15
 16 In the following sections, we build upon the basic details of this chapter. This includes a review of the
 17 science of eutrophication (including topics specific to large rivers) (**Section 2.0**), regulatory approaches
 18 for the control of eutrophication (**Section 3.0**), and then site-specific data compilation and modeling
 19 work specific to the Yellowstone River (**Sections 4.0-15.0**). Because the depth of some of these
 20 discussions will be beyond the interest of the many readers, specific topics applicable to each numbered
 21 box in **Figure 1-1** are provided below:

- 22
- 23 • Box 1 (identification of an appropriate model): **Section 5.0**
- 24 • Box 2 (data collection and literature review to support modeling): **Sections 6.0, 7.0**
- 25 • Box 3 (model calibration and validation): **Sections 8.0, 9.0, 10.0, 11.0**
- 26 • Box 4 (model nutrient-addition scenarios): **Sections 12.0, 13.0**
- 27 • Box 5 (uncertainty analysis): **Section 14.0**
- 28 • Box 6 (comparisons between the model results and other methods): **Section 15.0**

- 1 • Box 7 (establishment of numeric criteria): **Sections 12.0, 13.0, 14.0, 15.0**

2

3 In other words, for those interested only in criteria development and results, **Sections 12.0, 13.0, 14.0,**
4 **and 15.0** will suffice. However, for those who prefer in-depth technical details about modeling,
5 assumptions, background data and supporting files, and associated documentation, **Sections 5.0, 6.0,**
6 **7.0, 8.0, 9.0, 10.0, and 11.0** should be reviewed. The combined detail of these sections is sufficient such
7 that an independent reviewer who wishes to either reproduce the findings, or conduct critical analysis
8 or review of its contents and conclusions, can do so.

2.0 THE PROBLEM OF EUTROPHICATION

A basic understanding of eutrophication is fundamental to understanding objective of criteria development. We recommend review of **Section 2.0** of Suplee et al., (2008) for a complete summary of eutrophication in Montana’s wadeable streams and small rivers. A more focused review on large rivers is presented here. Other valuable references include Hynes (1966) and Laws (2000).

2.1 How Eutrophication Affects Large Rivers

Eutrophication causes a variety of water quality problems in flowing waters such as nuisance algal growth, altered aquatic communities, and undesirable water-quality changes that impair beneficial uses (Dodds, et al., 1997; Dodds, 2006; Freeman, 1986; Welch, 1992). Elevated algal levels are most notorious (**Figure 2-1**), and the green algae *Cladophora spp.* in particular has benefited from excess nutrients in lotic systems worldwide (Dodds, 1991; Freeman, 1986; Robinson and Hawkes, 1986; Tomlinson, et al., 2010; Whitton, 1970; Wong and Clark, 1975). Many other water quality problems are also associated with eutrophication. Those most commonly experienced are shown in **Table 2-1** (Smith, et al., 1999) and are disruptive to both humans and aquatic inhabitants.

Table 2-1. Water quality problems associated with nutrient enrichment.

Human Impacts ¹	Aquatic impacts ¹
1. Taste and odor problems	1. Harmful diel fluctuations in pH and dissolved oxygen
2. Reduced water clarity	2. Increased algal biomass
3. Blockage of intake screens and filters	3. Changes in species composition of algae
4. Disruption of flocculation and chlorination processes at water treatment plants	4. Macrophyte over-abundance
5. Increased numbers of disinfection by-products (which are carcinogenic)	5. Reduction in habitat for macroinvertebrates and fish
6. Restriction of swimming, boating, and other water-based recreation	6. Increased probability of fish kills
7. Fouling of submerged lines and nets	7. Toxic algae (more common with reservoir influence)
8. Reduced property values and amenity	8. Commercial fishery losses
9. Tourism losses	

¹From Smith, et al., (1999) and Dodds, et al., (2009).

2.1.1 Human and Societal Effects

The human and societal effects of eutrophication are notable. Common drinking water problems include taste and odor problems. Other health related concerns include elevated post-treatment disinfection-by-products (DBP) which are known or suspected carcinogens (these result from increased organic material in the chlorinated drinking water treatment precursor pool) (Palmstrom, et al., 1988; Sadiq and Rodriguez, 2004), and cyanobacterial blooms, which are rare, but are of great concern in that they are toxic to both humans and animals (Vasconcelos, 2006). Studies also indicate that greater accumulation of organochlorine pollutants (e.g., PCBs) occurs in trout populations (Berglund, et al., 1997; Berglund, 2003) when benthic algae density increases. PCBs can be passed up the food chain. Given the prior concerns, the effects of eutrophication are not always trivial or simply a nuisance.

1 Nor is the impact of eutrophication constrained strictly to health or ecology. Dodds, et al., (2009)
2 estimate that societal damages from eutrophication (e.g., reduced property values; loss of recreational
3 amenity; net economic losses for tourism and commercial use; and increased drinking water treatment)
4 total \$2.2 billion annually in the United States. Estimates are comparable to those made by Wilson and
5 Carpenter (1999) and Pretty, et al., (2003). Costs associated with policy response, in-water preventative
6 measures, or best management practices (BMP) are not included in these figures.
7



8
9 **Figure 2-1. Example of nuisance *Cladophora spp.* growth in the Yellowstone River (August 2006).**

10 11 **2.1.2 Ecological Impacts**

12
13 The ecological effect of eutrophication is significant also. Changes in fish population density or size
14 (Wang, et al., 2007), shifts to less sensitive species (Hynes, 1966), and a plethora of other long-term
15 chronic or acute ecological effects including loss of key or sensitive species or changed species
16 composition have all been reported (Pretty, et al., 2003). Altered diurnal DO and pH variation are the
17 most common (Walling and Webb, 1992). If the impact is significant enough (i.e., fluctuations become
18 too severe) fish kills can occur (Welch, 1992).
19

20 Aquatic insect or macroinvertebrate populations are also affected. Taxa shifts are frequently reported in
21 response to increasing enrichment and sensitive macroinvertebrates such as mayflies (*Ephemeroptera*),
22 stoneflies (*Plecoptera*) and caddisflies (*Trichoptera*) tend to prefer clean water with low nutrient
23 concentrations (i.e., without extreme daily DO oscillations) while midge species (chironomids) tend to be
24 abundant in heavy polluted water (Hilsenhoff, 1987; Hynes, 1966; Lenat and Penrose, 1996; Wang, et

1 al., 2007). In such systems, macroinvertebrate density and biomass tend to increase in relation to
2 enrichment, yet sensitive species diminish (Gücker, et al., 2006).

3 4 **2.1.3 Other Considerations**

5
6 Although not encapsulated in previous discussions, it should not go unmentioned that eutrophication
7 and small shifts in trophic status are not always harmful. For example, small increases of N and P have
8 been shown to increase the productivity of fisheries by increasing fish biomass, fish abundance, and
9 growth rates (deBruyn, et al., 2003; Deegan and Peterson, 1992; Harvey, et al., 1998; Perrin, et al.,
10 1987). This is exemplified in very nutrient poor watersheds. The Kootenai River in northwestern
11 Montana is one such example where managers seek to increase productivity through nutrient additions
12 (Holderman, et al., 2009; Hoyle, 2003). Consequently, enrichment only becomes a problem when the
13 effect manifests in an undesirable way relative to the waterbody's beneficial use.

14 15 **2.2 Factors that Influence Eutrophication in Large Rivers**

16
17 A number of environmental factors influence the eutrophication response of large rivers. Primarily these
18 differ from their wadeable counterparts most notably in available light, water depth, and other physical
19 features such as velocity and substrate. These differences are highlighted below.

20 21 **2.2.1 Light**

22
23 Light is a photosynthetic requirement that governs the rate at which algae grow (Hill, 1996). It is far
24 more abundant in wadeable streams than large rivers, which is primarily due to increases in both
25 turbidity and water depth. Factors that influence light remain the same regardless of the setting and
26 include things such as terrestrial vegetation adjacent to the river (i.e. shading from riparian canopy
27 cover), physical water depth, and adsorption and scattering properties of the medium. What sets
28 wadeable and non-wadeable systems apart is the extent of light limitation. Larger rivers tend to be more
29 light-limited than smaller ones.

30
31 To accomplish any meaningful change in algal growth rate, the amount of surface light reduction must
32 be 60% or more (Biggs, 2000a; Quinn, et al., 1997). The extent to which this occurs in one of Montana's
33 large rivers (the Yellowstone) is shown in **Figure 2-2** (top panel). Photosynthetically active radiation
34 (PAR) diminishes very quickly with depth and reaches a growth limiting threshold at approximately 0.5
35 meters. Attenuation is prominent for much of the channel (**Figure 2-2**, bottom panel) which leads us to
36 conclude that light-limitation is a mechanism of primary interest. In this example, much of the bottom
37 region is under strong light limitation whereas the near shore regions have ample light to stimulate algal
38 growth. We define these regions as distinctly separate management zones which take into account the
39 lateral variation of light. The non-wadadeable region encompasses areas of the river where depth
40 precludes significant algal accumulation. The wadeable region reflects the shallow areas of the river
41 where the effect of eutrophication is most significant.

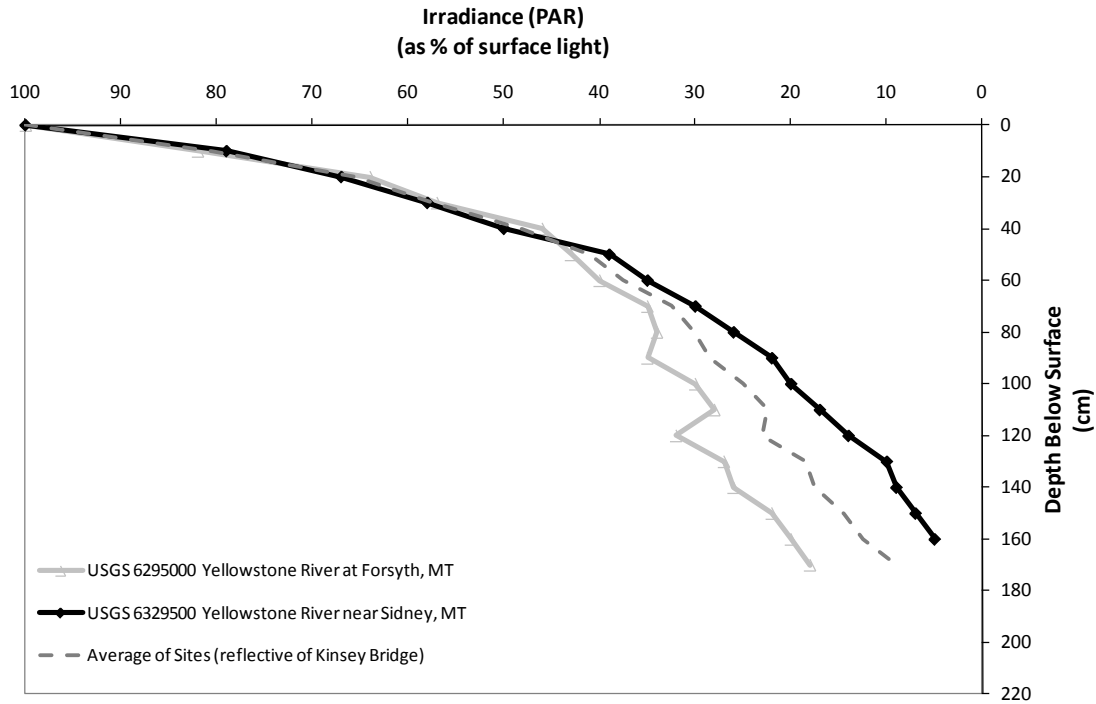

1

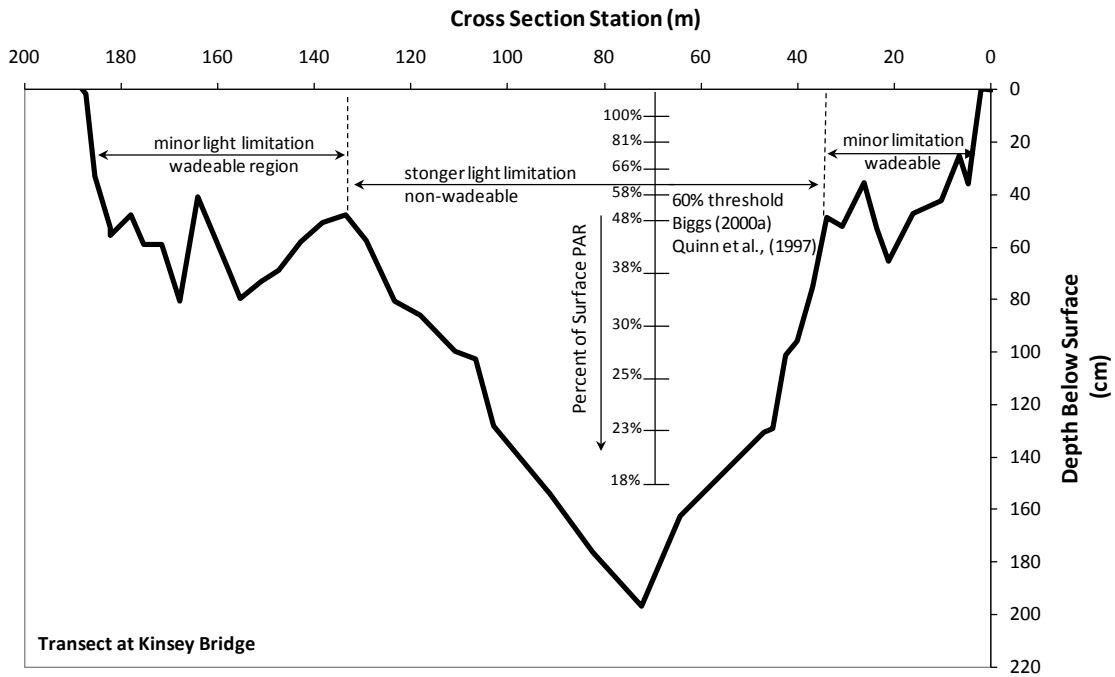

2

3

Figure 2-2. Light extinction in a Montana river and its lateral extent.

4

(Top panel) Light is quickly attenuated vertically in a Montana large river. In this example, only 50% of the surface

5

light is available at 40 cm (15 inches) and drops to 25% at 120 cm (4 ft). Data from U.S. Geological survey

6

(Peterson, 2009). (Bottom panel) A typical cross-section of that same river indicating the lateral extent of this

7

variation. Cross-section shown for Kinsey Bridge near Terry, MT which is approximately the midpoint of the two

8

irradiance stations (i.e., between Forsyth and Sidney).

1 The direct relationship between light and algal productivity is also apparent (**Figure 2-3**). In 2007, an
 2 influent tributary for the same river in **Figure 2-2** discharged highly turbid water that notably dampened
 3 productivity near our sonde [days 1 through 3 as evidenced by the effect on the diurnal dissolved
 4 oxygen (DO) swing (delta, Δ)]. The river then returned to normal turbidity levels on day 4 and an upward
 5 shift in productivity ensued. Hence there is a good correlation between light and photosynthesis. It is
 6 important to note that high turbidities were needed to hasten the dampening effect on the river (> 600
 7 nephelometric turbidity units, NTUs). This exemplifies the notion that eutrophication response is muted
 8 when rivers become light limited (Hill and Harvey, 1990; Quinn, et al., 1997; Rosemond, 1993).

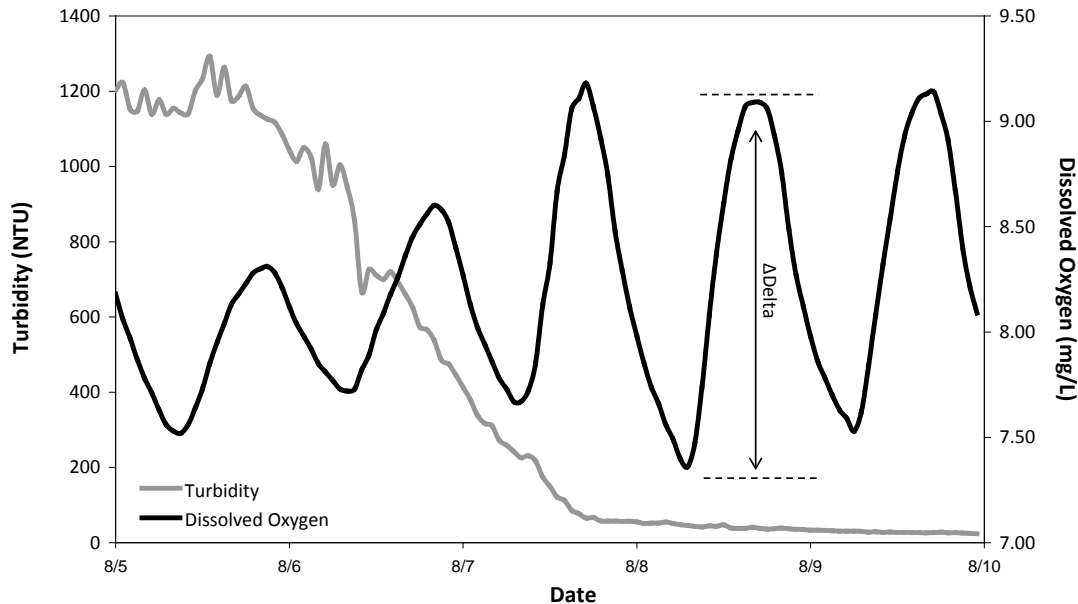

9
 10 **Figure 2-3. Influence of light attenuation on productivity in a Montana River.**

11 Unusually high turbidity dampened DO changes over a three day period. During the 4th day, turbidity dropped,
 12 and the magnitude of the diel DO oscillations (i.e., productivity) increased markedly.

13
 14 Light also influences the type of algal assemblage. According to Bayley, et al. (2007), the dominant
 15 algae in the shallow lakes of the Canadian Boreal Plain switch from year to year according to
 16 environmental conditions in the lake. Phytoplankton tend to be dominant when the water is turbid
 17 whereas submerged aquatic vegetation proliferate when the water is clear. A similar phenomenon likely
 18 occurs in large rivers, affirming the importance of light within the aquatic environment.

20 2.2.2 Velocity

21
 22 Velocity is also important. A hyperbolic relationship exists between velocity and growth where
 23 incremental increases stimulate algal metabolism up to a point (by increasing nutrient transport to cells)
 24 and then ultimately causes decreases through drag and scour (Stevenson, 1996). Shear velocities
 25 increasing from 0 to 8 cm s⁻¹ have been shown to allow larger mats and higher growth rates when
 26 compared to quiescent water because oncoming velocities force nutrients to reach algae cells at the
 27 base of the mat that might otherwise be starved of nutrients (Biggs, 2000a; Bothwell, 1989; Dodds,
 28 1991). In contrast, higher velocities (50-70 cm s⁻¹) cause excessive drag and lead to reduced biomass via
 29 sloughing and scour (Biggs, 1996; Horner, et al., 1990). Consequently, the range of 10-20 cm s⁻¹ for
 30 diatoms and 30-60 cm s⁻¹ for filamentous algae seems to be most conducive for algal growth (Stevenson,

1996). Velocity can also influence early cell development and accumulation, which is slower in faster velocities. This effect is probably only minor compared to the other effects.

2.2.3 Substrate

Substrate is a final consideration. Roughness and texture influence biomass accumulation and several studies have shown that biomass concentrates more rapidly on rough surfaces such as rocks and bricks than on smooth surfaces such as tile (Cattaneou, et al., 1997; Murdock and Dodds, 2007). Substrate motion and particle stability are also influential. Excessive movement can dislodge or damage algal cells upon impact (Peterson, 1996). Macroscopic algae are most susceptible to this kind of damage. Motile microalgae (i.e., those that can move) survive better than their sessile (fixed) counterparts in these setting (Burkholder, 1996). Finally, substrate size also affects growth dynamics. Large particles (i.e. boulders) increase algal settlement or emigration rates by slowing the velocity of the oncoming water whereas faster moving water (i.e., less roughness) has been shown to slow early cell development and accumulation. All of these are factors in large river algal accumulation and its spatial distribution. Based on this understanding, large rivers are most conducive to algae growth in shallow depositional zones where substrate stability is good and velocities are moderated by both substrate and river form.

2.3 Sources of Nitrogen and Phosphorus to Rivers

So far we have detailed only the environmental factors that influence eutrophication. The origin of the nutrients directly responsible for enrichment should also be discussed. N and P enter the aquatic environment from two primary ways: (1) from the atmosphere and (2) from the landscape. Natural sources (e.g., from rainfall, geochemical weathering erosion, etc.) are exacerbated by human activity. These anthropogenic sources are believed to exceed natural sources on a global scale, (Smith, et al., 1999; Vitousek, et al., 1997).

2.3.1 Atmospheric Sources

Atmospheric sources of nutrients are unavoidable and contribute a significant percentage of both N and P to aquatic systems. This is not surprising as nitrogen gas comprises approximately 78% of the atmosphere and P contributions occur from Aeolian (wind-based) transport. In unpolluted regions of the world, N concentrations in rainfall approach $400 \mu\text{g L}^{-1}$ (Meybeck, 1982). P depositional rates approximate $0.05\text{-}0.1 \text{ gP m}^{-2} \text{ yr}^{-1}$ (Neff, et al., 2008). Anthropogenic activity has altered natural deposition rates and N accumulation is believed to be 10-100 times greater in urbanized settings than unpolluted regions (Vitousek, et al., 1997) whereas P flux is 5 times higher than historical levels (Neff, et al., 2008). Changes are believed to stem from fossil fuel burning, large-scale land disturbance, over-application of fertilizer, and use of nitrogen fixing crops (Smith, et al., 1999).

2.3.2 Land-based Sources

Nutrients from the landscape add to the rainfall contribution and encompass things such as duff or litter accumulation in forests (Triska, et al., 1984), contributions from grasslands and native ungulates (Frank and Groffman, 2010), or lateral contributions of organic material associated with streambank erosion. Geologic sources are important as well. Dillon and Kirchner (1975) and Holloway, et al. (1998) show that geochemical weathering can greatly contribute to N and P yields in some watersheds. Minerals such as

1 apatite contribute to orthophosphate while ammonia bearing mica and feldspars are readily oxidized to
2 produce nitrate.

3

4 Human activity is probably the largest contributor of N and P however. Point sources (e.g., waste water
5 treatment plants) are the most conspicuous and have physically observable pipes that discharge directly
6 to streams. However, non-point sources are widespread too, and can be equally, if not larger, pollution
7 sources than point sources. Urban runoff and sprawl, land clearing and conversion, agriculture,
8 silviculture, and riparian degradation/stream bank erosion are all examples of non-point source
9 pollution (Hynes, 1969; Novotny and Olem, 1994; Porter, 1975; Smith, et al., 1999). These are most
10 prevalent during runoff, however can also have year-round effects such as in the case of septic effluent
11 or fertilizer leachate to groundwater. No effect has been as significant though as the Haber-Bosh
12 industrial process where unreactive atmospheric N is converted to ammonia salt to produce fertilizer
13 (Smith, et al., 1999; Vitousek, et al., 1997). This along with advances in cheap energy and equipment
14 technology which have greatly increased the disturbance trend in global nutrient cycling.

15

16

1

3.0 THE CONTROL OF EUTROPHICATION

Readers should refer to **Section 3.0** of Suplee, et al. (2008) for details on the state’s past, current, and proposed approaches to eutrophication control in surface waters. To summarize, DEQ has regulated nutrients using narrative criteria. These require that, “State surface waters must be free from substances attributable to municipal, industrial, agricultural practices or other discharges that will create concentrations or combinations of materials which are toxic or harmful to human, animal, plant, or aquatic life; or produce undesirable aquatic life” (ARM 17.30.637[1][d, e]).

To clarify, codified narrative statements such as above provide qualitative controls of harmful or undesirable conditions brought on by nutrients. However, because a narrative by definition lacks specificity and is open to interpretation, subjectivity is a potential concern. Adoption of numeric criteria will eliminate this fault and will provide readily measurable endpoints that are easier to monitor, regulate, and assess. Consequently, the criteria derived in this document closely reflect the spirit and intent of the narrative criterion, but also provide sufficient detail to make them of practical value.

3.1 Time-Period for Nutrient Control

Past nutrient criteria development activities have focused on limiting the eutrophication response during a period when the impact would be most severe, such as during baseflow or the growing season (Dodds, et al., 1997; Suplee, et al., 2008). Our present work is no different, and required us to identify the critical time-period for nutrient control in large rivers within temperature mountainous settings. We considered the following:

- Water temperature, which needs to be warm enough for algae to grow.
- Light, which should be luminous enough that photosynthesis outpaces respiration.
- Streamflow, which needs to be at flows low enough that dilution and nutrient load assimilative capacity is greatly diminished.

From our analysis of the first bullet above (water temperature), the growing season in Montana could potentially extend from April 1-October 31¹ (**Figure 3-1**).

¹ This assumes a growth limiting threshold of 5°C, similar to that of the nuisance algae genus *Cladophora* (Whitton, 1970). Data was evaluated from the following sites to make this conclusion: Missouri River at Toston, MT (06054500); Madison River bl Ennis Lake nr McAllister, MT (06041000); Yellowstone River nr Livingston, MT (06192500); Clark Fork at Superior, MT (12353650); Flathead River at Columbia Falls, MT (12363000); and Flathead River at Perma, MT (12388700). Several rivers not actually classified as large rivers, but with similar character were also included to make the dataset more robust [e.g., Dearborn River nr Craig, MT (06073500), Sun River near Vaughn, MT (06089000), Blackfoot River nr Bonner, MT (12340000); and Bitterroot River near Missoula, MT (12352500)].

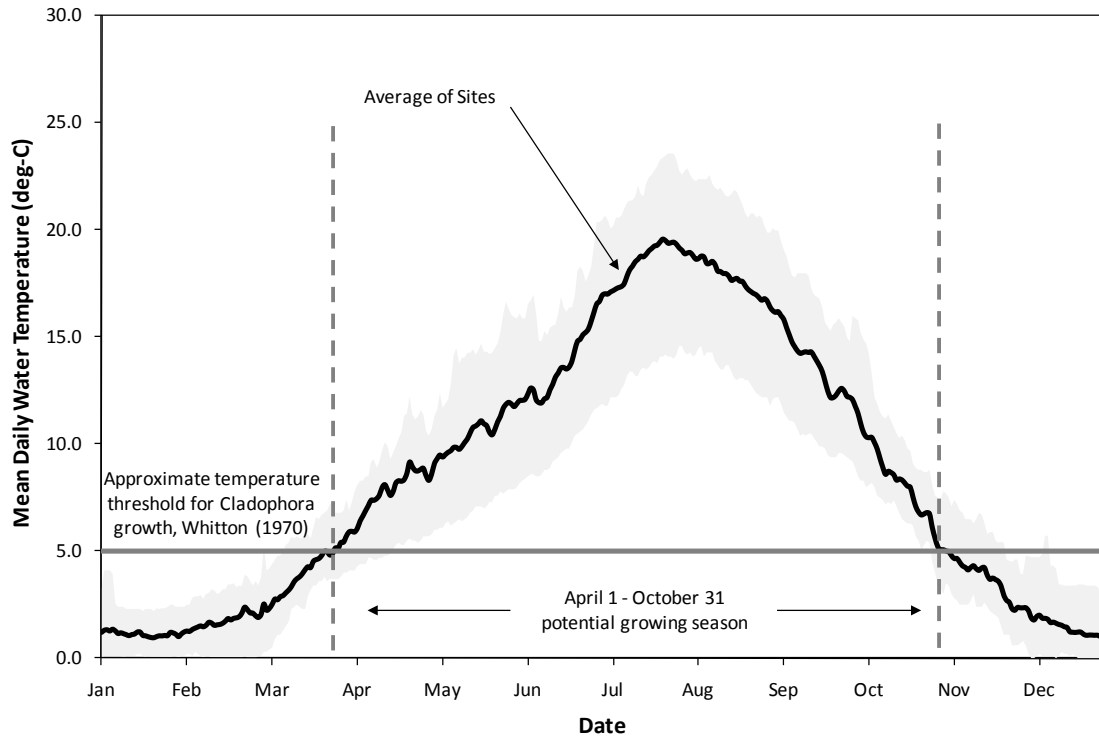

Figure 3-1. Plot of mean daily water temperature against algal growth limiting threshold.

Data includes a compilation of nine rivers in Montana with sufficient record to characterize long-term variation in water temperature. Sites include the Bitterroot, Blackfoot, Clark Fork, Dearborn, Flathead (2 sites), Missouri, Madison, Sun, and Yellowstone rivers. Temperatures above 5°C from April to November are indicative of periods when algal growth could proliferate [as suggested in Whitton (1970)].

The actual growing season, however, is shortened by light-limitation during runoff. For example, the suspended sediment concentration in most Montana rivers during freshet is 100-200 mg L⁻¹. The effect on photosynthetic capacity can be approximated according to the Beer-Lambert law (**Equation 1-1**) where $PFD_{surface}$ and PFD_{depthz} = the photon flux density (PFD) at the surface¹ and bottom of the channel respectively, k_e = light extinction coefficient [m⁻¹, dependent on suspended sediment concentration² (SSC)], and where, z = mean hydraulic depth of the river³ [m].

(Equation 1-1)

$$PFD_{depthz} = PFD_{surface} e^{(-k_e z)}$$

¹ Surface irradiances taken from Lewistown, MT (Wilcox and Marion, 2008).

² Daily k_e calculated from daily SSC, where non-volatile solids were estimated from Ittekkot and Laane (1991) and partial extinction coefficients were as specified in Di Toro (1978).

³ Mean daily hydraulic depth estimated using mean daily discharge and site rating curve.

- 1 Optimal light conditions extend from approximately July 1-October 31 (**Figure 3-2**) assuming that
 2 intensities below the half-saturation constant would limit nuisance growth¹.

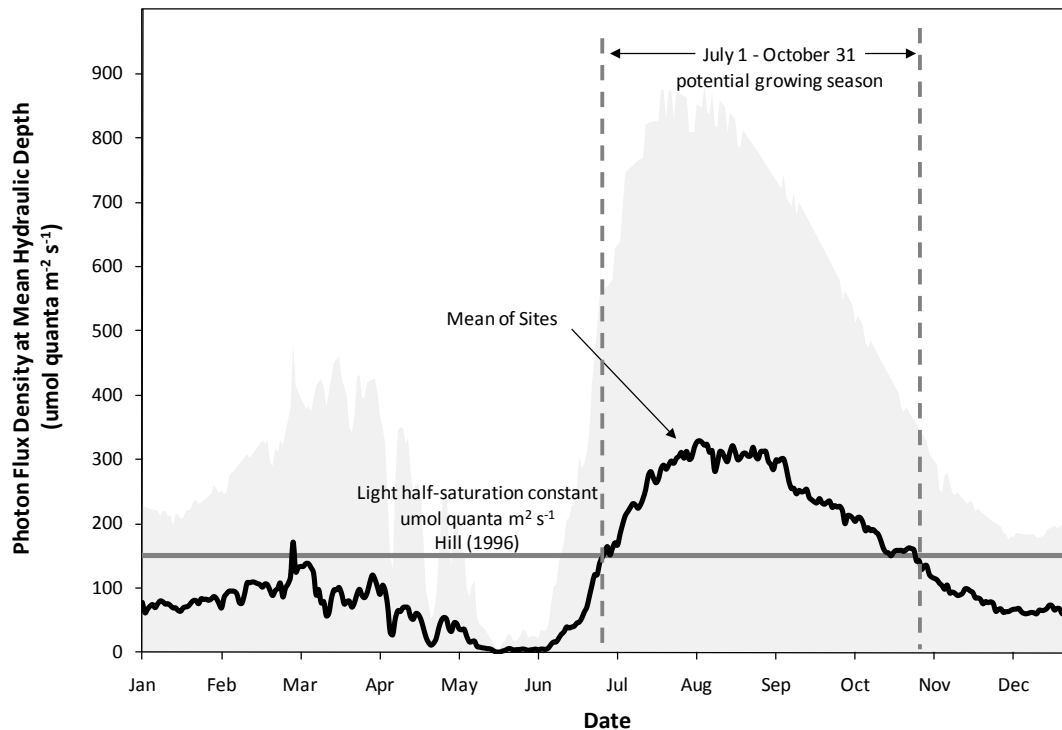

3
 4 **Figure 3-2. Plots of daily photon flux density against algal growth limiting threshold.**
 5 Based on a compilation of Montana Rivers².

6
 7 Streamflow was the final consideration. From review of **Figure 3-3**, mean daily river flows in Montana
 8 reach an inflection point on the falling limb of the hydrograph around August 1 which represents the
 9 transition from snowmelt to baseflow. A period of stability then follows which continues throughout the
 10 winter. Consequently, the critical period for nutrient control on the large rivers in Montana according to
 11 temperature, light, and streamflow constraints should occur over the period of August 1-October 31,
 12 when conditions are most apt to manifest nuisance responses. Monitoring, assessment, and modeling
 13 work should therefore target that period.

¹ We used the midpoint of the range identified in Hill (1996) which approximated 150 $\mu\text{mole quanta m}^{-2} \text{s}^{-1}$.

² Only a handful of sites in the state had SSC data. These were the: Missouri River nr Landusky, MT (06115200); Missouri River nr Culbertson, MT (06185500); Yellowstone River at Billings, MT (06214500); and Yellowstone River at Forsyth, MT (06295000). To supplement this data, several other rivers were also included. These included: the Little Bighorn River nr Hardin, MT (0629400); Clark Fork at Turah Bridge nr Bonner, MT (12334550); Clark Fork above Missoula, MT (12340500); and the Blackfoot River nr Bonner, MT (12340000).

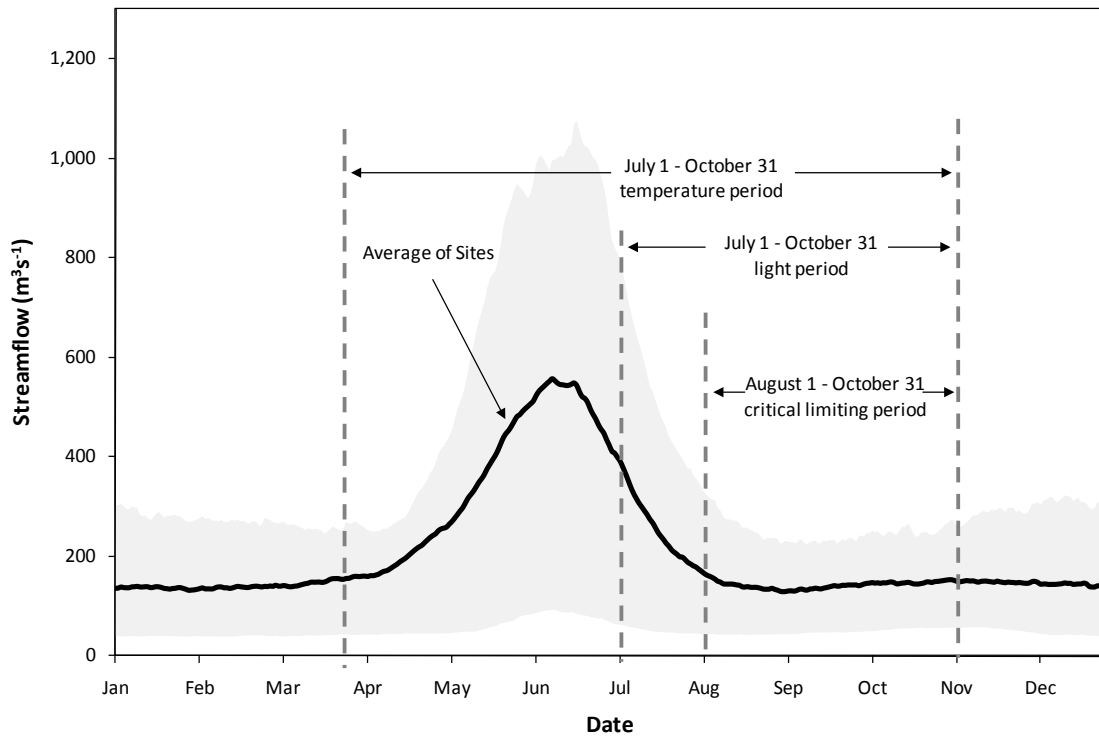

1
2 **Figure 3-3. Streamflow hydrology and the critical period for large river criteria development.**
3 The most restrictive period relative to temperature, light, and streamflow is from August 1-October 31. Monitoring
4 and assessment activities should target this timeframe for large river criteria development.

5

6 **3.2 Total Nutrients as Recommended Criteria**

7

8 Nutrient criteria necessitate that a specific target be achieved, for example the constituent that will be
9 measured in the field to ensure endpoint compliance. Total nitrogen (TN) and total phosphorus (TP) are
10 obvious choices as they have been shown to provide better overall correlations to eutrophication
11 response than soluble nutrients (Dodds, et al., 1997; Dodds, et al., 2002; Dodds, 2006). They also
12 coincide with the minimum acceptable nutrient criteria outlined by U.S. EPA (EPA, 2000b) and better
13 lend themselves to ambient nutrient monitoring, permit compliance, and monitoring. Accordingly, DEQ
14 will adopt these as targets. We will also evaluate soluble nutrients, but will not promulgate them as such
15 fractions are difficult to quantify in the field (i.e., you can have a highly eutrophic river with no
16 measureable soluble nutrients because they are immediately taken up by algae).

17

18 **3.3 Expected Difficulties with Numeric Nutrient Criteria Development**

19

20 Because this is one of the first national efforts to derive criteria with a water quality model in a large
21 river (Carleton, et al., 2009; Reckhow, et al., 2005; Smith and Tran, 2010; Weigel and Robertson, 2007),
22 there will undoubtedly be difficulty. In our opinion, the major issues surrounding our approach include:
23 (1) concerns about using water quality models for criteria development, (2) the spatial or geographic
24 specificity of the criteria, (3) localized factors that cause deviations from proposed criteria, and (4) the
25 achievability and affordability of the criteria. These items are briefly addressed below.

26

3.3.1 Concerns with Using Models

Water quality models are imperfect mathematical representations of complicated biogeochemical processes. This makes them easy to criticize. We recognize this concern, and understand that discussions regarding the use of models have been around for some time (Arhonditsis and Brett, 2004; Box and Draper, 1987). However, advancements in theory, data collection, computing, GIS capability, data visualization and display, and automation have made previous criticisms increasingly unfounded. Consequently, planning tools such as Q2K and others, are being considered more and more for regulatory purposes, including criteria development (Carleton, et al., 2005; Carleton, et al., 2009). Their use is advocated by decades of laboratory and field research studies [e.g., Streeter and Phelps, (1925) through current], and today we have the added latitude of sophisticated computing and highly accurate analytical data.

3.3.2 Longitudinal Variability of Proposed Criteria

Longitudinal variation in criteria is another important consideration in criteria development. River response to enrichment changes longitudinally as the physical continuum of the river is altered (Vannote, et al., 1980). To simplify these ecosystem structure and functional gradients into practical units for management, DEQ has used reach-indexing. Indexing effectively segments waterbodies at logical breakpoints according to major tributaries, shifts in river behavior, jurisdictional boundaries, or ecosystem or ecoregional boundaries. Descriptions of these breakpoints relative to the Yellowstone River are identified in **Section 4.4**.

3.3.3 Factors that Mitigate Eutrophication

Cases will also exist where localized or temporary environmental conditions mitigate the expected eutrophication response. As such, criteria for those locations will not be valid. Unusual flow events, uncharacteristic climatic conditions, or other atypical factors are all examples that stretch the limits of criteria. These will be addressed on a case-by-case basis, if necessary.

Downstream requirements for lakes, reservoirs, and impoundments (75-5-306[2], §MCA), or interstate compacts or agreements were also not considered. We recognize this to be a pressing issue, but cannot do so as there is insufficient information to promulgate criteria for Lake Sacajawea (the first downstream reservoir located in North Dakota) for example, or for subsequent reservoirs downstream or the Gulf of Mexico. From a practical standpoint, low-flow criteria discussed herein are only a small percentage of the annual load to these waterbodies, thus are likely insignificant.

3.3.4 Economics

Finally, it is apparent that the nutrient concentrations typically required to prevent unwanted aspects of eutrophication are relatively low when compared to current wastewater treatment technologies. The scientific literature indicates only small amounts of enrichment are needed to manifest large changes in stream productivity (Bothwell, 1989). Thus it is possible that endpoints determined through this modeling will be difficult to achieve. DEQ is developing implementation policies that will help stakeholders deal with this contingency on a case-by-case basis. Efforts are on-going, and are not

1 detailed here. It is DEQ's general position that numeric nutrient criteria are ultimately achievable, even
2 if time is needed for treatment technology to advance, and costs to come down.

3

4

5

4.0 CRITERIA DEVELOPMENT FOR THE YELLOWSTONE RIVER

Our criteria development work was initiated on the Yellowstone River in eastern Montana. It is a principal tributary to the Missouri River and one of the few remaining free-flowing rivers in the conterminous United States (Benke and Cushing, 2005). Identified by National Geographic magazine as “America's last best river” (Chapple, 1997), its prominence and importance make it an ideal candidate for criteria development testing. This is reinforced by the fact that a large proportion of Montana’s population lives along its shores.

4.1 Watershed Description

The headwaters of the Yellowstone River originate in Yellowstone National Park and drain 181,480 km² (70,100 mi²) of the rugged Rocky Mountains and arid foothills prairie of the Northwestern Great Plains. The river flows 1,091 km (672.8 mi) through the landscapes of central Wyoming, southeastern Montana, and western North Dakota before reaching its endpoint with the Missouri River just east of the Montana-North Dakota state border (**Figure 4-1**). The criteria study reach (highlighted in red) extends from Forsyth to Glendive, MT. It is further detailed in **Section 4.2**.

Approximately 55% of the contributing watershed is part of the Northwestern Great Plains province although smaller percentages come from the Wyoming Basin and Middle Rockies ecoregion (Zelt, et al., 1999). Rangeland and brush are the dominant land cover types (combined 74%) while forest and agricultural lands comprise much of the remaining percentage (14 and 9% respectively) (Miller, et al., 2004). The estimated basin population is 323,000 (Miller, et al., 2004), and includes 38 municipal discharge facilities, 48 confined animal feeding operations, 78 stormwater permits, and 83 industrial facilities (in Montana alone). Those within Wyoming are not included.

Watershed relief is considerable and elevations span from 580-4200 meters (1,900-13,800 feet) (Miller, et al., 2004). The variability in topography results in significant spatial differences in climate. Valleys are semiarid and temperate while the mountains are cold and moist. Average annual precipitation in each area ranges from 150 mm (6 inches) to over 1,500 mm (60 inches) (Miller, et al., 2004) while air temperatures fluctuate between -40°C and 38°C annually (-40°F to 100°F). Regional climate and seasonal regimen are determined by the interaction of air masses originating in the Gulf of Mexico, northern Pacific Ocean, and the Arctic regions (Zelt, et al., 1999). Gulf air is prevalent in the spring and summer months while Pacific and Arctic air occur in the fall and winter.

Water yield comes principally from high elevation snowmelt runoff from the Absaroka-Beartooth, Wind River, and Bighorn mountain ranges (Thomas and Anderson, 1976). Runoff is second only to Clark Fork River in Montana and mean annual streamflow at USGS 06329500 Yellowstone River near Sidney, MT is 365 m³ s⁻¹ (12,900 ft³ s⁻¹). Annual peaks approach 1,200 m³ s⁻¹ (42,200 ft³ s⁻¹) and low flows are near 143 m³ s⁻¹ (5,060 ft³ s⁻¹) (McCarthy, 2004). These are typical of the project site. Major contributing tributaries include the Clark’s Fork of the Yellowstone River, Bighorn River, Tongue River, and Powder River. All originate from the south and west, and most are regulated by reservoirs.

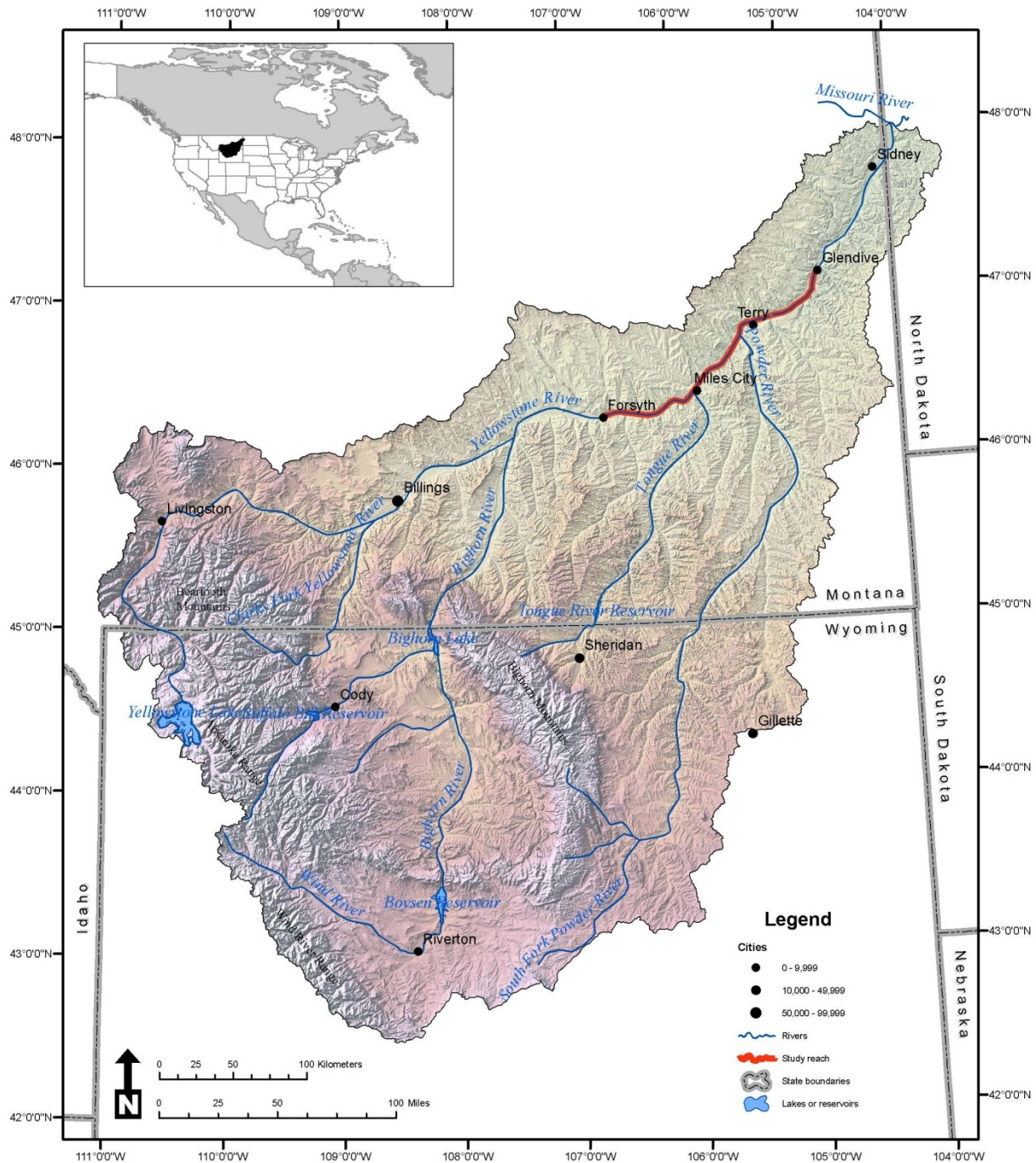

1
 2 **Figure 4-1. Yellowstone River area watershed in Montana, Wyoming, and North Dakota.**
 3 The reach evaluated in this study is shown in red.
 4

5 **4.2 Lower River Study Area**
 6

7 The focus of our study was on the lower part of the Yellowstone River between Forsyth and Glendive,
 8 MT. The reach is 232.9 km (144.7 miles) long and is most easily accessed by I-94 which parallels the river

1 **(Figure 4-2)**. The Highway 59 Bridge (at Forsyth) and Bell Street Bridge in Glendive demark the upper
2 and lower study limits. Physiography of this area is characteristic of the Great Plains ecoregion with
3 expansive rolling hills and prairie and dissected and erodible topography (Smith, et al., 2000; Zelt, et al.,
4 1999). Topographic relief is minimal [typically less than 150m, (Zelt, et al., 1999)], and limited mainly to
5 the badlands east and south of Glendive (Smith, et al., 2000). The rest of the reach contains gently
6 rolling topography that has developed in the easily erodible shales of the region (Zelt, et al., 1999).

7
8 River morphology is predominantly single thread with occasional braided channels (Benke and Cushing,
9 2005). The river has a wide and well armored low-flow channel and then a fairly expansive near-channel
10 disturbance zone from annual flooding. Several natural bedrock grade controls exist at key locations
11 which prevent major channel adjustments (AGDTM, 2004). Slopes of 0.0005-0.0007 m m⁻¹ and
12 sinuosities of 1.25 are common (Koch, et al., 1977), and riparian vegetation communities consist of
13 willow (*Salix* spp.), cottonwood (*Populus* spp.), blue grama (*Bouteloua gracilis*) and western wheatgrass
14 (*Agropyron smithii*) (White and Bramblett, 1993). An overview of representative physiographic regions
15 of the study reach is in **Figure 4-3**.

16
17 Climate of the lower river is semi-arid continental (Lesica and Miles, 2001; Peel, et al., 2007; Smith, et
18 al., 2000). Three long-term daily climate stations provide daily information within the project site. These
19 are located at Forsyth (243098), Miles City Municipal Airport (APT) (245690), and Glendive (343581)
20 (**Table 4-1**). Normals for the 1971-2000 period for each site are shown in **Figure 4-4** (left) and air
21 temperatures range from -13.7 to 31.0°C (7.4-87.9°F) while precipitation is 340-360 mm (13.5-14.1
22 inches) annually (WRCC, 2009). Most precipitation comes as rainfall in the months of June and
23 September. The frost-free summer period is 140-150 days (State Engineer's Office, 1948; Zelt, et al.,
24 1999) and is characteristic of hot and dry conditions with evaporation between 750-1000 mm (30-40 in).

25
26 Five active streamflow gaging stations are present to characterize hydrology within the project reach
27 (**Table 4-2**). Three are on the mainstem river: (1) USGS 06295000 Yellowstone River at Forsyth, MT, (2)
28 USGS 06309000 Yellowstone River at Miles City, MT, and (3) USGS 06327500 Yellowstone River at
29 Glendive, MT; while two on the tributaries: USGS 06308500 Tongue River at Miles City, MT and USGS
30 06326500 Powder River near Locate, MT.

31
32 Flows at the main-stem locations are fairly similar throughout the study reach with the exception of
33 runoff. During this time there is a notable increase in flow with drainage area. This suggests that much
34 of the drainage basin is ephemeral and does not contribute significantly to low-flow. The streamflow
35 regimen is characteristic of a snowmelt watershed with a small-magnitude early spring rise due to
36 localized low-elevation snow melt, and then a prolonged high-magnitude peak from the large stores of
37 snow-water equivalent in the upper basin (**Figure 4-4**).

38
39 The major tributaries (Tongue and Powder rivers) enter at roughly one-third and two-thirds of the
40 overall project length. They contribute significantly during the snowmelt runoff period (resulting in most
41 of the variance between the gages on the main-stem river). However, they only marginally contribute to
42 the overall water yield during the summer months.

1

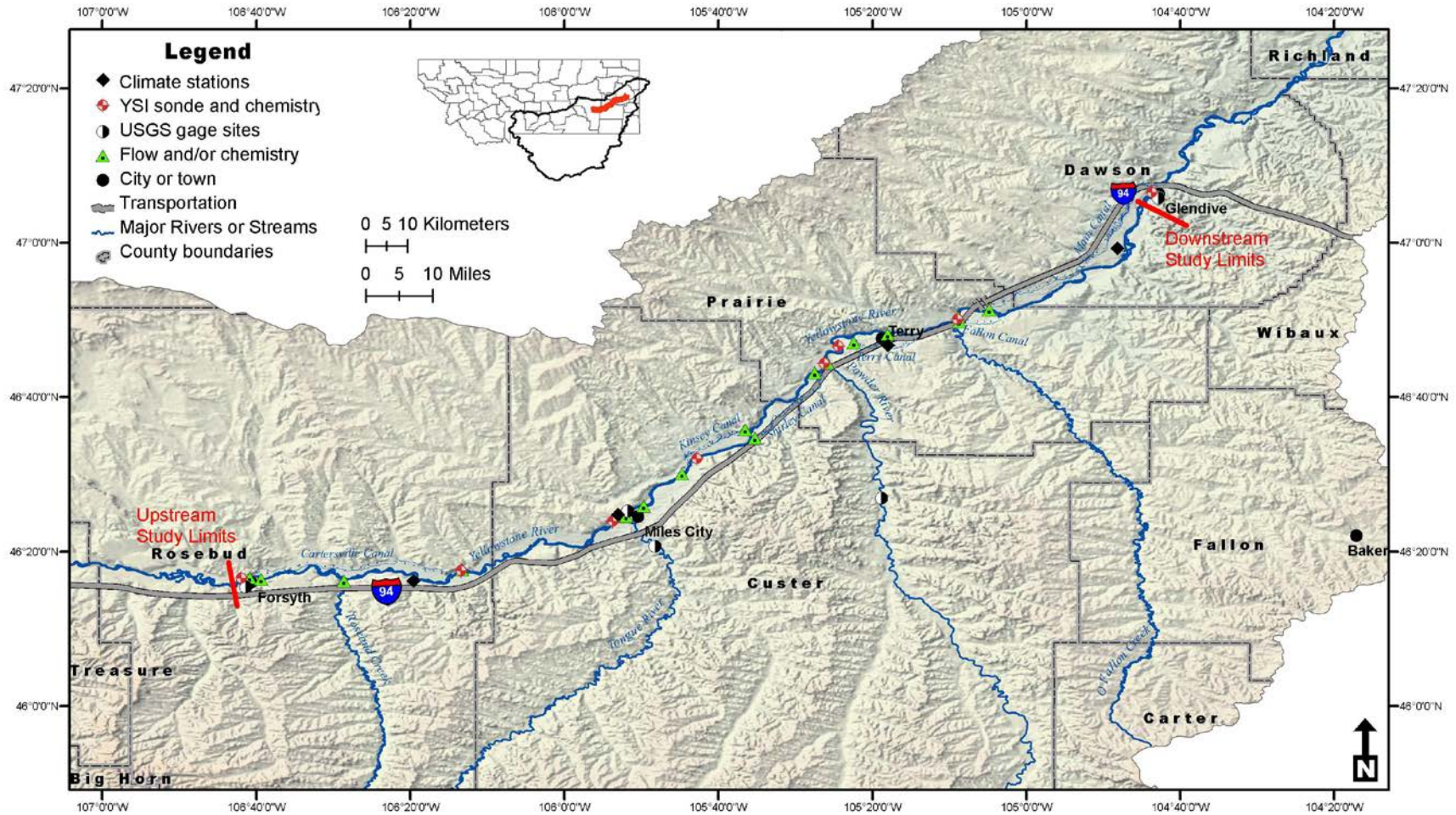

2
3
4
5
6

Figure 4-2. Lower Yellowstone River study area showing monitoring locations and other features.

1
2
3
4
5
6
7
8
9
10
11
12
13
14
15
16
17
18
19
20
21
22
23
24
25
26
27
28
29
30
31
32
33
34

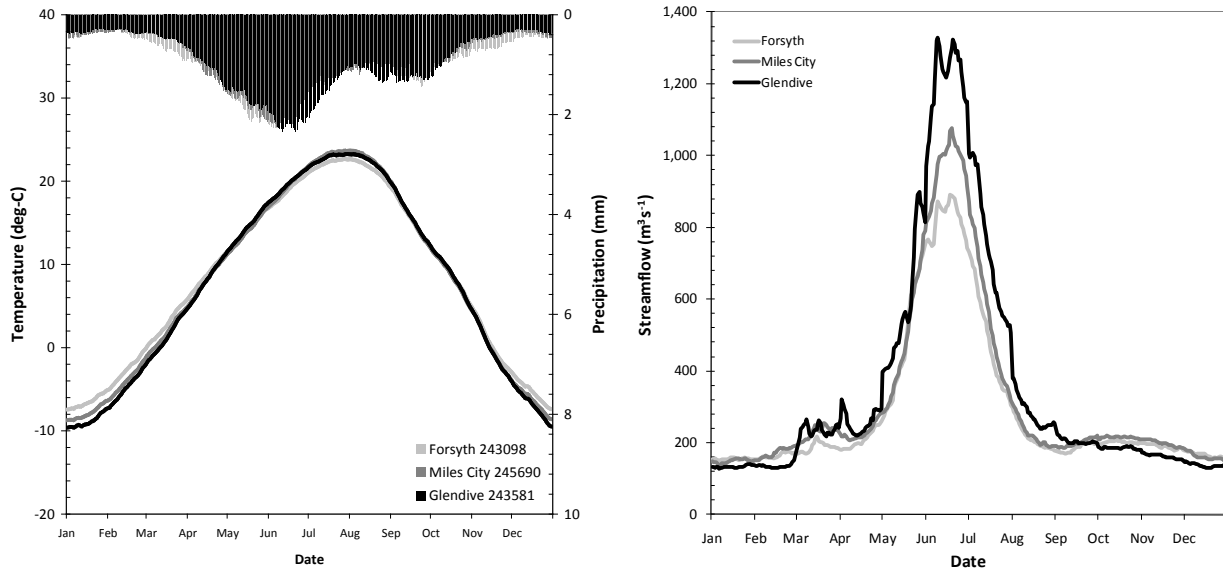

Figure 4-3. Representative regions of the lower Yellowstone River project site.

1 **Table 4-1. Long-term climatic stations on the lower Yellowstone River.**

Station ID	Station	Latitude	Longitude	Station Elevation (m)	Period of Record
243098	Forsyth, MT	46.267	-106.667	767	1975-current
245690	Miles City APT, MT	46.433	-105.883	800	1936-current
243581	Glendive, MT	47.100	-104.717	633	1893-current

2



3

4 **Figure 4-4. Mean daily normals for the lower Yellowstone River.**

5 (Left panel) 1971-2000 precipitation and temperature for Forsyth (243098), Miles City F Wiley Fld (245690), and
 6 Glendive, MT (243581), (Right panel) 2000-2008 mean daily streamflow at USGS Yellowstone River at Forsyth
 7 (06295000), Miles City (06309000), and Glendive, MT (06327500).

8

9 **Table 4-2. Active streamflow gaging stations on the Yellowstone River.**

10 Data from USGS NWIS (accessed 9/25/08).

Station ID	Description	Lat.	Long.	Drainage Area (km ²)	Mean annual streamflow	
					(m ³ s ⁻¹)	(ft ³ s ⁻¹)
06295000	Yellowstone River at Forsyth, MT	46.266	-106.690	103,933	287	10,150
06308500	Tongue River at Miles City, MT	46.385	-105.845	13,972	11	399
06309000	Yellowstone River at Miles City, MT	46.422	-105.861	124,921	316	11,160
06326500	Powder River near Locate, MT	46.430	-105.309	33,832	16	558
06327500	Yellowstone River at Glendive, MT	47.106	-104.717	172,779	356	12,560

11

12 **4.3 Beneficial Uses and Water Quality Standards for the River**

13

14 The beneficial use class designations for our study reach are found in the Administrative Rules of
 15 Montana (ARM 17.30.611). Accordingly, the lower Yellowstone River is a B-3 water (ARM, 17.30.625)
 16 and beneficial uses and criteria that DEQ is required to protect are detailed in **Table 4-3** (established by

1 ARM 17.30.625 and DEQ-7). The focus of modeling will be to link these already established water quality
 2 standards (e.g., DO, pH, nuisance algae, etc. from **Table 4-3**) to nutrient concentrations that will be
 3 protective of such beneficial uses.

4
 5 **Table 4-3. Water-use classification, beneficial uses, and standards for the lower Yellowstone River.**

Segment Description	Use Class	Beneficial Uses
Yellowstone River mainstem from the Billings water supply intake to the North Dakota state line	B-3 ¹	Drinking, recreation, non-salmonid fishery and associated aquatic life, waterfowl and furbearers, agricultural and industrial water supply
Standards for B-3 waters (e.g. lower Yellowstone River) are:		
<ol style="list-style-type: none"> 1. Dissolved oxygen levels $\geq 5 \text{ mg L}^{-1}$, in order to protect aquatic life and fishery uses (early life stages; DEQ 2010). 2. Total dissolved gas levels, which must be $\leq 110\%$ of saturation to protect aquatic life (DEQ 2010). 3. Induced variation of hydrogen ion concentration (pH), which must be less than 0.5 pH units within the range of 6.5 to 9.0, or without change outside this range ([ARM 17.30.625(2)(c)] to protect aquatic life. 4. Turbidity levels, which a maximum increase of 10 nephelometric turbidity units (NTU) is acceptable; except as permitted in 75-5-318, MCA [ARM 17.30.625(2)(d)] to protect aquatic life. 5. Benthic algae levels, which DEQ interprets per our narrative standard (ARM 17.30.637(1)(e) should be maintained below a nuisance threshold of $150 \text{ mgChla m}^{-2}$ to protect recreational use. 		

6
 7 **4.4 Limits of Criteria Derived in this Study**

8
 9 Nutrient criteria derived in this study will be limited to specific longitudinal extents. Four candidate
 10 criteria assessment “units” (i.e., different longitudinal river reaches) were identified to accommodate
 11 changes in river behavior. These were based on waterbody segment IDs and are as follows: (Unit 1), the
 12 Middle Rockies region B-1 zone which extends from the Wyoming state-line to the Laurel public water
 13 supply (PWS) (MT42K001_010); (Unit 2), the B-2 and B-3 zone from the Laurel PWS to the Bighorn River
 14 (MT42K001_020); (Unit 3), the B-3 middle great plains region from the Bighorn River to the Powder
 15 River (MT42M001_011); and (Unit 4), the lower great plains region B-3 zone from the Powder River to
 16 the state-line (MT42M001_011) (**Table 4-4**). Only the latter two units are being evaluated as part of this
 17 study. The first two units (1 and 2) will be evaluated in the future. Field data collection for this work was
 18 originally scheduled for summer 2011, but has been pushed back to 2012 due to other department
 19 commitments and unusually high flows.

20
 21
 22
 23
 24
 25

¹ Water use classes B-1 and B-2 not evaluated as part of this study (they are located upstream).

Table 4-4. Waterbody segments proposed for nutrient criteria development.

Only Units 3 and 4 are being addressed as part of this report.

Criteria Unit	Waterbody Segment ID(s)	Segment Description(s)	Use Class
1	MT43B001_011	Montana State border to Yellowstone Park Boundary	B-1
	MT43B001_010	Yellowstone Park Boundary to Reese Creek	B-1
	MT43B003_010	Reese Creek to Bridger Creek	B-1
	MT43F001_012	Bridger Creek to City of Laurel PWS	B-1
2	MT43F001_011	City of Laurel PWS to City of Billings PWS	B-2
	MT43F001_010	City of Billings PWS to Huntley Diversion Dam	B-3
	MT43Q001_011	Huntley Diversion Dam to Big Horn River	B-3
3	MT42K001_020	Big Horn River to Cartersville Diversion Dam	B-3
	MT42K001_010	Cartersville Diversion Dam to Powder River	B-3
4	MT42M001_012	Powder River to Lower Yellowstone Diversion Dam	B-3
	MT42M001_011	Lower Yellowstone Diversion Dam to North Dakota border	B-3

4.5 Historical Water Quality Summary

A historical summary of water quality on the Yellowstone River is of importance because of the vast changes that have taken place over the past 60 years. A cursory review is presented below so that readers may understand the current context with reference to historical conditions.

Interest in Yellowstone River water quality first peaked in the early 1950s as a result of Federal Water Pollution Control Act of 1948 (Pub. L. No. 80-845, 62 Stat. 1155). Taste and odor problems had become a problem because the river was effectively receiving untreated municipal and industrial waste water (Montana Board of Health, 1952). Complaints had been filed at a number of locations regarding things such as oily wastes and oil-tasting fish, odors from sugar-beet discharges, contributions of blood and animal tissue from meat-packing plants, raw sewage, and other unpleasantries (Montana Board of Health, 1952; Montana Board of Health, 1956). Aggressive waste control policies were therefore recommended by the Montana Board of Health (1956) to mitigate these impacts.

Soon a number of municipal and industrial sewage treatment plants were in planning or already under construction (Montana Board of Health, 1963), and by 1977 the river was declared as “nearly” meeting state water quality standards (Karp, et al., 1977). Recent water quality assessments tend to support this assertion. DEQ currently identifies the river as either being “fully” or “partially” supporting beneficial uses on the lower river based on a recent assessment (DEQ, 2009).

From these past efforts, pollution in the watershed has been well characterized (Karp, et al., 1977; Montana Board of Health, 1956; Montana Board of Health, 1963; Montana Board of Health, 1967). Major wastewater and industrial facilities are located in Livingston, Billings, Forsyth, Miles City, Glendive, and Sidney. A number of other MPDES permits are also present including industrial discharges, confined animal feeding operations (CAFOs), and stormwater permits.

The single largest tributary non-point source is the Powder River, which is responsible for at least 30% of the annual suspended sediment load to the river (Zelt, et al., 1999). It has been described as a mile wide, too thin to plow, and too thick to drink (Montana Board of Health, 1952). Much of its contribution may

1 be natural. A number of other anthropogenic non-point sources are believed to occur including
2 agriculture, urban expansion, septic systems, land clearing, mining, and silviculture.
3
4 Three distinct water quality segments have also been delineated in the past to characterize water
5 quality. These include: (1) the upper reach which drains the mountainous perennial streams and rivers
6 upstream of Laurel, (2) a middle portion consisting of perennial headwaters and intermittent prairie
7 regions extending from Laurel to Terry, and (3) a segment downstream of Terry to Sidney with primarily
8 intermittent streams (Klarich and Thomas, 1977). These generally correspond with the locations
9 identified in **Table 4.4** and reflect a steady and gradual decline in water quality that occurs due to both
10 natural and anthropogenic causes (Klarich, 1976; Thomas and Anderson, 1976; Zelt, et al., 1999).
11 Relative contributions from these sources are yet to be quantified.

12
13 Groundwater of the region is a final consideration and is generally of poor quality. Smith, et al., (2000)
14 indicate that the shallow hydrologic unit (nearest the river) is moderately polluted and wells within 70
15 feet of the ground surface have shown the greatest impact. It is believed that the interaction is related
16 to agriculture, near-surface geologic materials, and recharge. The groundwater is highly mineralized
17 naturally and the average dissolved constituent concentration is greater than 1,400 milligrams per liter
18 (mg L^{-1}) (Smith, et al., 2000). The nutrient increases are believed to be man-caused.

19
20
21
22
23

1

5.0 MODELING STRATEGY

The modeling strategy for the project was to develop nutrient criteria limits by using a water quality model to understand the linkage between nutrients and associated water quality responses. We then would extrapolate these linkages to numeric nutrient criteria thresholds. The modeling rigor was matched with the necessary level of confidence required in the outcome. Given the socio-political and economic burden that can ensue from nutrient controls (e.g., wastewater treatment plant upgrade costs, pollutant trading requirements, etc.), a high level of detail was necessitated. This was then balanced with a number of other practical factors including available funding and resources, data collection requirements, project scope, and management effort. A steady-state (as opposed to dynamic) modeling approach was selected due to its relative simplicity and more modest data requirements.

5.1 Rationale for the Model DEQ Selected

The model that DEQ selected for the Yellowstone work was the enhanced river water quality model QUAL2K. It was chosen for the following reasons: (1) its ability to simulate the eutrophication response state-variables of interest, (2) nation-wide use in dissolved oxygen (DO) modeling, TMDL planning, and wasteload studies (Crabtree, et al., 1986; Drolc and Koncan, 1996; Rauch, et al., 1998), (3) modest data requirements, (4) relative simplicity in model application and development, (5) very good modeling documentation and user support (Chapra, et al., 2008), and (6) endorsement by EPA (Wool, 2009). Further details regarding its selection are described in the project QAPP (**Appendix A**).

5.2 QUAL2K Description

QUAL2K (Q2K) (Chapra, et al., 2008) is a steady-flow, one-dimensional water quality model that solves advection and dispersion mass transport and constituent reactions along the direction of flow. It represents a revision of the original QUAL2E (Brown and Barnwell, 1987), and includes the following improvements: variable sized elements, multiple loadings and withdrawals, carbonaceous biochemical oxygen demand (CBOD) speciation, sediment-water interactions, and the addition of bottom algae. Numerical computations in Q2K are programmed in Fortran 90, and are implemented from the Microsoft Excel and Visual Basic for Applications (VBA) environment. The addition of bottom algae and light extinction are huge improvements over the QUAL2E version, as benthic algae have an important biological role in regional rivers and a profound effect on beneficial uses. In addition, the current system has improved optics which is of great benefit given the impact of the Powder River on water clarity.

Over 20 water quality state-variables are simulated in Q2K, many which are eutrophication related. Included are: temperature, alkalinity, pH, conductivity, dissolved oxygen (DO), carbonaceous biochemical oxygen demand (CBOD), organic-nitrogen (N), ammonia-N, nitrate N, organic-phosphorus (P), inorganic-P, suspended algae, attached algae, internal nitrogen and phosphorus of algae, and inorganic and volatile suspended solids. A finite difference balance in terms of flow, heat, and concentration is written within each element for each constituent which in turn provides conditions for the adjacent elements in the model grid. Q2K can be used in a quasi-dynamic mode where water temperature, kinetics, and algal growth rates are allowed to vary diurnally so that the user can study the daily fluctuation over a 24-hr cycle (Chapra, et al., 2008).

Q2K is not without limitations though and should only be applied when stream flow and input waste loads are approximately steady-state, and where lateral and vertical gradients in water quality are negligible. Additional information about the modeling software and documentation can be found at: <http://www.epa.gov/athens/wwqtsc/html/qual2k.html>.

5.2.1 Conceptual Representation

Q2K represents a river as a series of interconnected reaches and elements that are in steady-state with one another. A prototype river is shown in **Figure 5-1** and consists of (1) a headwater boundary condition, (2) downstream reaches which are interconnected, and (3) a downstream boundary condition. Reaches can further be subdivided into elements of equal length; these are the fundamental computational unit of the model. Mass can be gained or lost from anywhere in the model network including tributaries and point and non-point source contributions, or withdrawals.

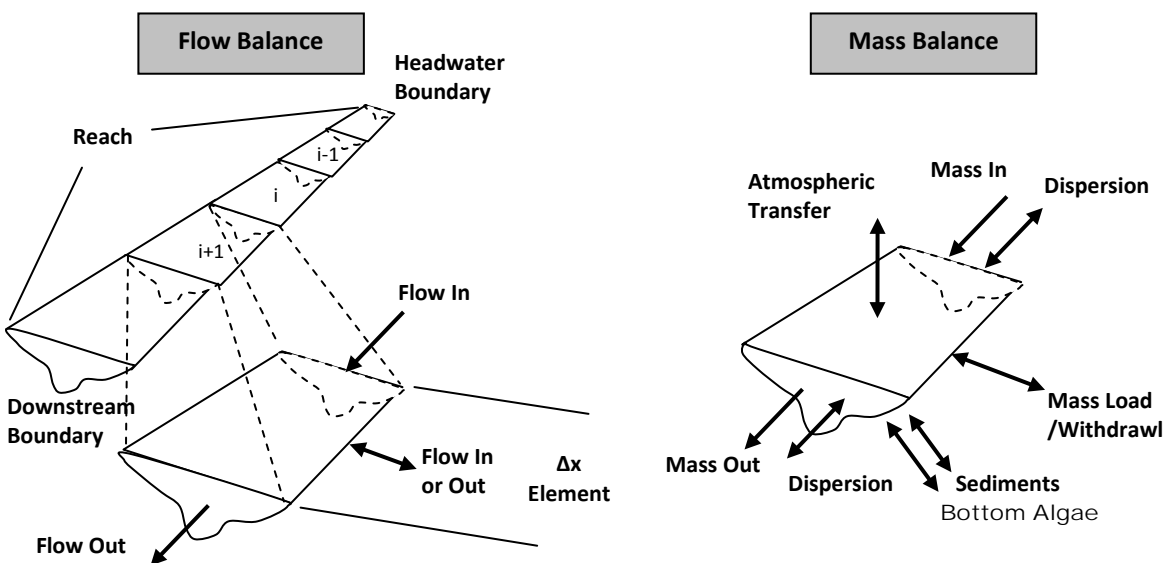

Figure 5-1. Conceptual representation of Q2K (redrawn from Brown and Barnwell, 2004).

(Left panel) Flow balance. (Right panel) Mass balance.

5.2.2 Temperature Model

The temperature algorithms of Q2K are deterministic and govern all reaction kinetics. Five heat exchange processes are simulated: net solar shortwave radiation into the water, longwave radiation from the atmosphere, longwave radiation from the water back to the atmosphere, conduction between the air/water and the water/bed boundary layers, and evaporative heat transfer. The overall mass balance is framed in the terms of heat (**Equation 5-1**), where T_i = temperature in element i [$^{\circ}\text{C}$], t = time [d], Q_i = outflow from element i to next downstream element [$\text{m}^3 \text{d}^{-1}$], $Q_{\text{out},i}$ = total additional outflows from element i [$\text{m}^3 \text{d}^{-1}$], V_i = volume of element i [m^3], E'_i = the bulk dispersion coefficient between elements i and $i + 1$ [$\text{m}^3 \text{d}^{-1}$], $W_{h,i}$ = the net heat load from point and non-point sources into element i [cal d^{-1}], H_i = depth of element i [m], ρ_w = the density of water [g cm^{-3}], C_{pw} = the specific heat of water [$\text{cal (g } ^{\circ}\text{C)}^{-1}$], $J_{a,i}$ = the air-water heat flux [$\text{cal (cm}^2 \text{d)}^{-1}$], and $J_{s,i}$ = the sediment-water heat flux [$\text{cal (cm}^2 \text{d)}^{-1}$] (Chapra, et al., 2008).

1

$$\frac{dT_i}{dt} = \frac{Q_{i-1}}{V_i} T_{i-1} - \frac{Q_i}{V_i} T_i - \frac{Q_{out,i}}{V_i} T_i + \frac{E'_{i-1}}{V_i} (T_{i-1} - T_i) + \frac{E'_i}{V_i} (T_{i+1} - T_i)$$

2 **(Equation 5-1)**

$$+ \frac{W_{h,i}}{\rho_w C_{pw} V_i} \left(\frac{\text{m}^3}{10^6 \text{ cm}^3} \right) + \frac{J_{a,i}}{\rho_w C_{pw} H_i} \left(\frac{\text{m}}{100 \text{ cm}} \right) + \frac{J_{s,i}}{\rho_w C_{pw} H_i} \left(\frac{\text{m}}{100 \text{ cm}} \right)$$

3

4 Incoming shortwave radiation is modeled via latitude, longitude, and time of the year. It is attenuated
5 by atmospheric transmission, cloud cover, reflection, and topographic or vegetative shading. Longwave
6 radiation is calculated according to the Stefan-Boltzmann law, and conduction and evaporation are
7 calculated using wind-dependent relationships. As outlined in **(Equation 5-1)**, advection and dispersion
8 are then used to calculate heat transfer from upstream to downstream elements.

9

10 **5.2.3 Constituent Model**

11

12 The constituent mass-balance within Q2K includes all key eutrophication components of interest
13 including N and P cycling (e.g., hydrolysis, settling, uptake, nitrification, denitrification), algal growth
14 processes (photosynthesis, respiration, death, and excretion), and oxygen kinetics and mass transfer
15 (carbonaceous biochemical oxygen demand, reaeration, sediment oxygen demand). Model state-
16 variables are shown in **Table 5-1** and a conceptual diagram of model kinetics is shown in **Figure 5-2**.

17

18 **Table 5-1. Model state-variables in Q2K.**

State-Variable	Symbol	Units
Conductivity	<i>s</i>	µmhos
Inorganic suspended solids	<i>m_i</i>	mg D L ⁻¹
Dissolved oxygen	<i>O_o</i>	mg O ₂ L ⁻¹
Slowly reacting CBOD	<i>c_s</i>	mg O ₂ L ⁻¹
Fast reacting CBOD	<i>c_f</i>	mg O ₂ L ⁻¹
Organic nitrogen	<i>n_o</i>	µg N L ⁻¹
Ammonia nitrogen	<i>n_a</i>	µg N L ⁻¹
Nitrate nitrogen	<i>n_n</i>	µg N L ⁻¹
Organic phosphorus	<i>p_o</i>	µg P L ⁻¹
Inorganic phosphorus	<i>p_i</i>	µg P L ⁻¹
Phytoplankton	<i>a_p</i>	µg A L ⁻¹
Phytoplankton nitrogen	<i>IN_p</i>	µg N L ⁻¹
Phytoplankton phosphorus	<i>IP_p</i>	µg P L ⁻¹
Detritus	<i>m_o</i>	mg D L ⁻¹
Alkalinity	<i>Alk</i>	mg CaCO ₃ L ⁻¹
Total inorganic carbon	<i>c_T</i>	mole L ⁻¹
Bottom algae biomass	<i>a_b</i>	mgA m ⁻²
Bottom algae nitrogen	<i>IN_b</i>	mgN m ⁻²
Bottom algae phosphorus	<i>IP_b</i>	mgP m ⁻²

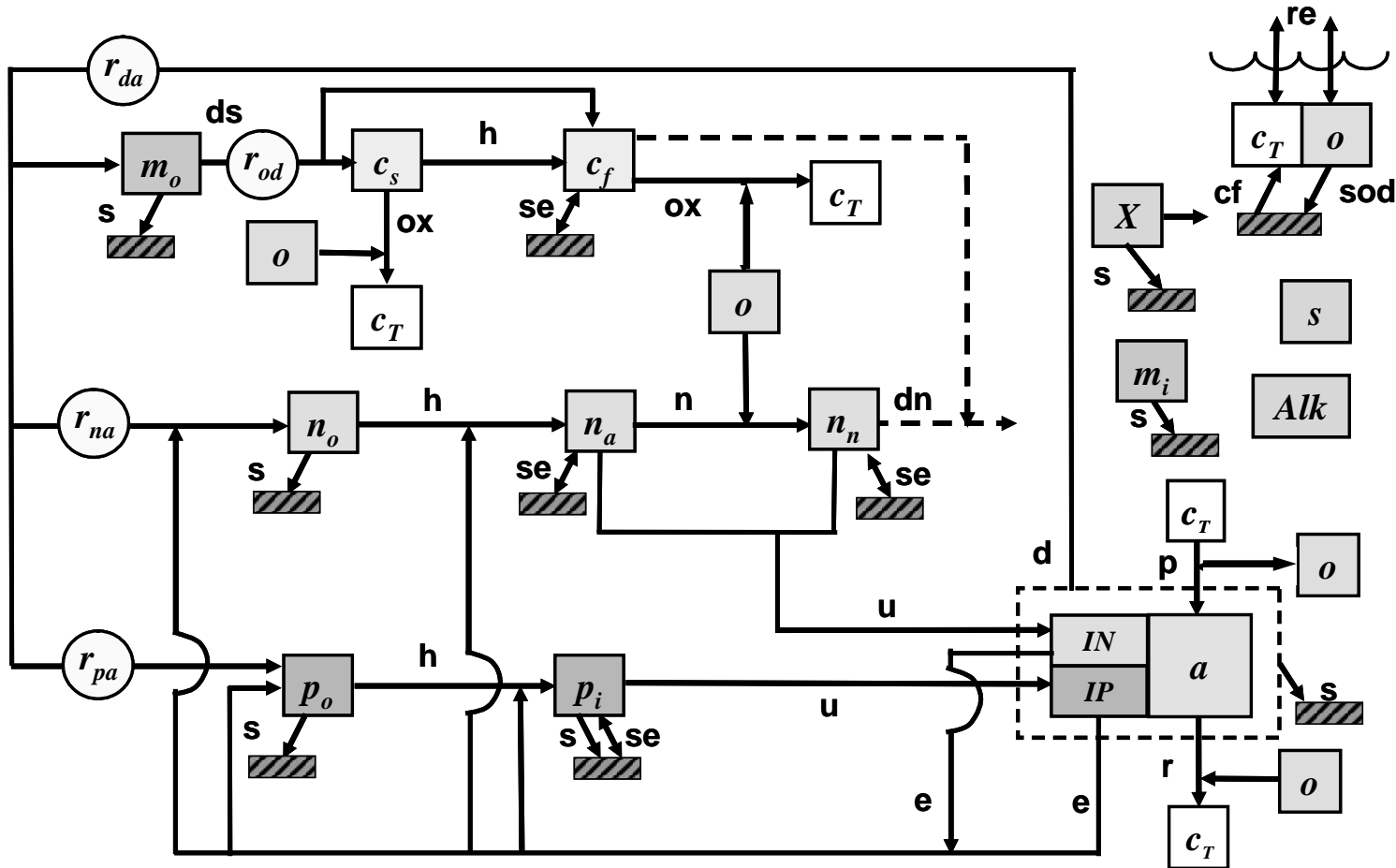

1
 2 **Figure 5-2. Diagram of model kinetics and mass transport processes in Q2K.**
 3 Redrawn from Chapra, 2008 (with permission). Kinetic processes are as follows: ds = dissolution, h = hydrolysis, ox = oxidation, n = nitrification, dn =
 4 denitrification, p = photosynthesis, r = respiration, e = excretion, d = death, r = respiration. Mass transfer processes are: re = reaeration, s = settling, SOD =
 5 sediment oxygen demand, se = sediment exchange, cf = inorganic carbon flux, u = uptake.

1 A general mass balance for constituents within each element are written as in **Equation 5-2**.

2

3 **(Equation 5-2)**
$$\frac{dc_i}{dt} = \frac{Q_{i-1}}{V_i} c_{i-1} - \frac{Q_i}{V_i} c_i - \frac{Q_{out,i}}{V_i} c_i + \frac{E'_{i-1}}{V_i} (c_{i-1} - c_i) + \frac{E'_i}{V_i} (c_{i+1} - c_i) + \frac{W_i}{V_i} + S_i$$

4

5 where c_i = the constituent concentration in element i , W_i = the external loading of the constituent to

6 element i [g d^{-1} or mg d^{-1}], and S_i = sources and sinks of the constituent due to reactions and mass

7 transfer mechanisms [$\text{g (m}^3\text{d)}^{-1}$ or $\text{mg (m}^3\text{d)}^{-1}$]. For bottom algae variables, the transport and loading

8 terms are omitted.

9

10 5.3 General Data Requirements for QUAL2K

11

12 The data requirements for Q2K are lengthy but generally include headwater and climatic forcings (e.g.,

13 streamflow, mass/quality constituents, climatic information, etc.), ancillary boundary condition

14 information (e.g., point source inflows, diffuse flows, etc.), advection and dispersion mass transport

15 formulations, rate and kinetic coefficients, and benthic processes. All of these are necessary model

16 inputs and are required to provide a good representation of the physical system and biogeochemical

17 rates. Ways to obtain such information include (in decreasing order of accuracy): (1) direct field

18 measurements, (2) indirect observations from field data, (3) model calibration, or (4) the literature

19 (Barnwell, et al., 2004). Data collection for the project was structured to meet these data requirements

20 as described in **Section 6.0**.

21

22 5.4 Assumptions and Limitations

23

24 A number of assumptions and limitations are implicit with the use of Q2K. Those of importance to our

25 effort include:

- 26
- 27 • Complete mixing, both vertically and laterally.
 - 28 • Approximate steady-state conditions¹.

29

30 In the first bullet, it is assumed that the major pollutant transport mechanisms (advection and

31 dispersion) are significant only along the longitudinal direction of flow. This was confirmed as detailed in

32 **Section 5.5**². For the latter, our selection of the critical low-flow period largely corresponds to steady-

33 state conditions as the river is hydrologically and thermally stable (see **Section 5.5**).

¹ Q2K simulates a single day's streamflow, water quality, and meteorological conditions (or an average of multiple days of conditions) repeatedly for a user-specified number of days. Thus, a dynamic steady-state is computed for that day, or period of days. Diurnal changes are brought about by shifts in hourly temperature, meteorological data, and solar radiation and photoperiod.

² The exception being areas directly downstream of WWTPs or tributary inflows where it is obvious that significant lateral water quality gradients exist. The modeling network was carefully constructed so that issues at those sites were minimized.

5.5 Verification of Model Assumptions

The assumptions framed in **Section 5.4** were verified in the field in 2006. Complete vertical and lateral mixing was confirmed at a number of cross-section locations using a YSI 85 hand-held meter by taking a measurements both laterally and vertically in the water column (Suplee, et al., 2006a). Site water quality was fairly homogeneous at all sites in the river¹.

Steady-state streamflow, boundary condition, and biological assumptions were affirmed through a review of historical thermal and hydrologic data on the river. It was assumed that these measures would be a good surrogate of nutrient loading and biological activity² and our analysis indicates that relatively stable conditions³ occur around the second or third-week of August and persist through the end of September (**Table 5-2, Figure 5-3**). Hence this is a good time for field data collection and associated model development work. Please refer to the project QAPP for more information regarding these findings (**Appendix A**) (Suplee, et al., 2006a).

Table 5-2. Verification of steady-state flow requirements for QUAL2K.

Based on analysis of USGS gage 06295000 Yellowstone River at Forsyth, MT (1977-2008)¹.

Week	Week Beginning Streamflow	Week End Streamflow	Change in Flow (%)
August 1-7	10,500	8,500	-19.0
August 7-13	8,500	7,280	-14.4
August 13-19	7,280	6,880	-5.5 (begin steady-flow) ²
August 19-25	6,880	6,570	-4.5
August 25-31	6,570	6,210	-5.5
September 1-7	6,240	5,970	-4.3
September 7-13	5,970	6,370	+6.7
September 13-19	6,370	6,850	+7.5
September 19	6,850	7,160	+4.5
September 25	7,160	6,930	-3.2

¹Comparisons made with published USGS data records.

²Variation $< \pm 10\%$ considered acceptable for steady-flow model applications.

¹ DO and temperature were used as the indicator. Surface-to-bottom dissolved oxygen gradients were negligible except in one instance, within the filamentous *Cladophora* beds. These gradients did not extend up into the water column above the algae beds however.

² Streamflow stability would tend to suggest that nutrient loads would be fairly constant over the time period. This is true for tributaries and natural settings, but could be altered by anthropogenic effects (e.g., WWTP, septic, etc.). Water temperature is a good indicator of biological activity. It governs all of the rate constants in the model (according to the Arrhenius equation).

³ Here we define stability as a change no greater than 10% over a one week period.

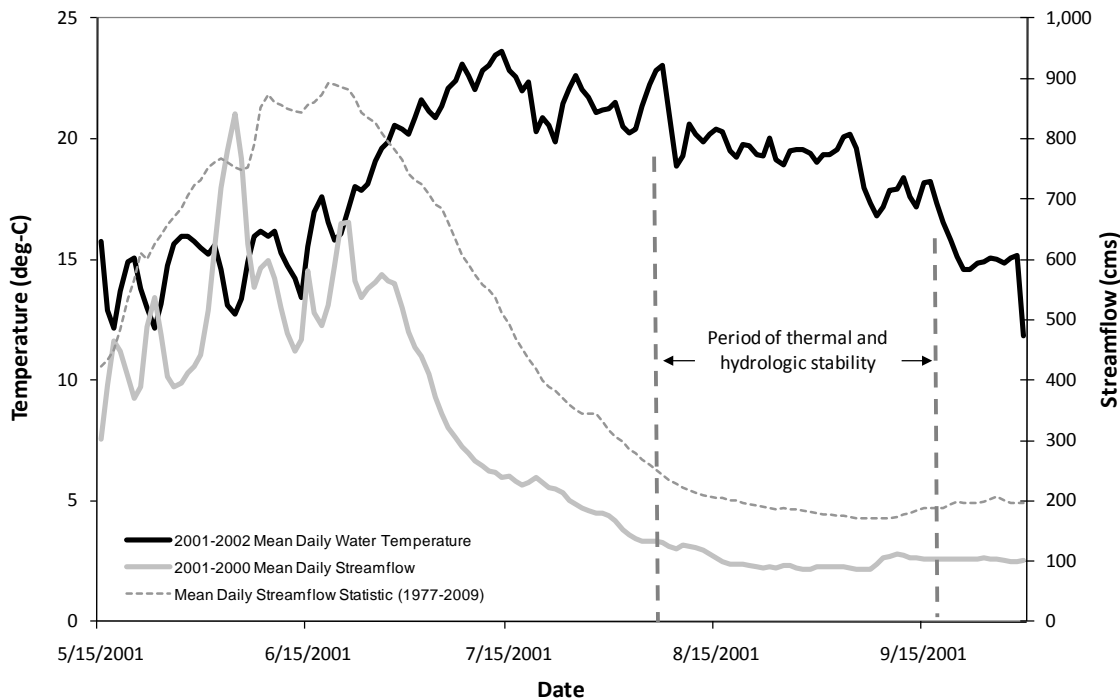

1
2 **Figure 5-3. Typical occurrence of thermal and hydrologic stability in the Yellowstone River.**

3 The onset of thermal and hydrologic stability begins approximately August 1 and continues into late September.
4 Temperature data from 2001-2002 were obtained by taking the flow-weighted average of USGS 06214500
5 Yellowstone River at Billings, MT and USGS 06294500 Bighorn River above Tullock Creek, near Bighorn, MT.
6

7 **5.6 AlgaeTransect2K (AT2K; a Q2K Cross-section Model)**

8
9 DEQ worked cooperatively with Tufts University to develop a new model, AlgaeTransect2K (AT2K). AT2K
10 relates longitudinal Q2K model output to lateral benthic algae densities, and such a tool was needed
11 because bottom algae typically exhibit lateral heterogeneity in rivers with higher densities in the shallow
12 near-shore areas and lower biomasses in deeper areas. The importance of these shallow (or wadeable)
13 areas is reinforced by the fact that human use and perception is often inclined towards these locations
14 (i.e., they are the locations where recreational use is highest). Consequently, AT2K was developed to fill
15 an existing deficiency in Q2K, which currently is limited to only simulating mean cross-sectional river
16 biomass.
17

18 AT2K's conceptual representation is shown in **Figure 5-4**. A single river element is represented by lateral
19 transect variation in depth z [m] with distance y [m] over an element of wetted width [B, m], where algal
20 biomass ($\text{mg Chl } a \text{ m}^{-2}$) is computed as a function of attenuated light to the channel bottom, soluble
21 nutrient concentrations (N and P), and algal growth kinetics. Rather than running the calculation for
22 every station, AT2K first develops a table of biomasses and associated depth increments, and then

1 linearly interpolates mean biomass levels for each depth in the transect. A finer, more uniformly-spaced
 2 depth profile can also be generated between soundings if desired. Assumptions of AT2K encompass all
 3 of those identified for Q2K, including that constituent water quality is sufficiently well-mixed vertically
 4 and laterally¹ and that the effects of velocity, channel substrate, and riparian shade are insignificant.

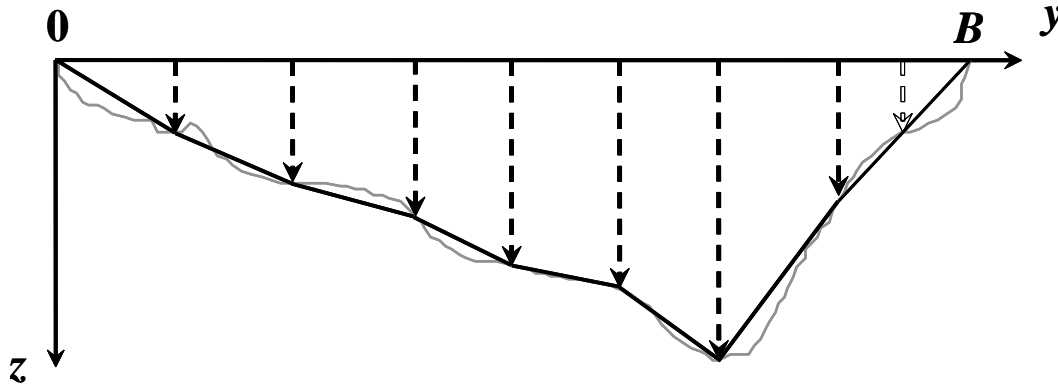

5
6
7 **Figure 5-4. Conceptual representation of the AlgaeTransect2K (AT2K) model.**

8 The model represents a river transect as a single Q2K element with variable depth to evaluate the effect of lateral
 9 light attenuation on algal growth. The primary consideration in the development of AT2K was to make it consistent
 10 with the existing version of Q2K. As a result Q2K optics and algal growth submodels are used for all calculations².

11 12 **5.7 Why the Transect Model (AT2K) was Needed**

13
14 Two primary considerations necessitated AT2K development for large river settings. First, lateral benthic
 15 algal dynamics in large rivers are poorly understood and require a better understanding of the
 16 relationship between nutrients and algal density. For example, we may over- or under-state the
 17 eutrophication problem if we do not consider the integrated response of change in light over depth.
 18 This prompted us to propose criteria that address the mean biomass of the wadeable region, which
 19 integrates the response to light and addresses each of the prior concerns. Second, based on our
 20 understanding of large rivers, current information seems to suggest that adverse water column
 21 responses (i.e., standards violations for things such as DO or pH) may be unlikely except in cases of gross
 22 or negligent pollution. The Yellowstone River is a good example of this, as even during times of heavy
 23 historic pollution (Montana Board of Health, 1956; Montana Board of Health, 1967) the river rarely ever

¹ The assumption of a homogeneous water column is often true, however, it could be violated immediately downstream from a major point sources such as a WWTP or tributary inflow. Such considerations should be taken into account during model development.

² The following mechanistic processes are represented in the model: optics (light extinction over depth, i.e., Beer-Lambert law), photosynthetic light use efficiency (Baly, 1935; Smith, 1936; Steele, 1962), nutrient uptake (Rhee, 1973), and nutrient limitation (Droop, 1973). State-variables simulated include: (1) bottom-algae biomass, a_b , mgA m^{-2} , (2) bottom-algae internal phosphorus, IP_b , mgP m^{-2} , and (3) bottom-algae internal nitrogen, IN_b , mgN m^{-2} . Please refer to Chapra (2008) for further details.

1 had noted water column impairment (e.g., DO minima, pH, etc.). Four general conclusions about higher-
2 gradient rivers like those in Montana further support this conclusion:

- 3
- 4 • Turbidity and depth are both naturally greater in these systems, in so doing naturally pushing
5 them towards light limitation (Hynes, 1969).
- 6 • The volume of water per unit area is also high, which makes the biomass per unit volume low,
7 thereby limiting the eutrophication response (Hynes, 1969).
- 8 • Atmospheric oxygen/carbon dioxide reaeration coefficients are high which lend themselves to
9 kinetically fast, natural purification processes.
- 10 • Channel bottoms are gravel/cobble and have low amounts of fine sediment and organic matter
11 and consequently low sediment oxygen demands (SOD) (e.g., $<0.5 \text{ g O}_2 \text{ m}^{-2} \text{ day}^{-1}$).
- 12

13 Consequently, there is a natural propensity for large rivers to be less sensitive to nutrient pollution than
14 smaller streams. However, proper assessment of support/non-support of beneficial uses in large rivers
15 requires evaluation of nutrient levels that can limit nuisance biomass in the wadeable regions. A model
16 such as AT2K is needed to conduct such evaluations.

1

6.0 PROJECT DESIGN, DATA COLLECTION, AND SUPPORTING STUDIES

The project design for the Yellowstone River was reflected in the overarching question posed at the beginning of the study (Suplee, et al., 2006a): “in a segment of the lower Yellowstone River, what are the highest allowable concentrations of nitrogen and phosphorus that will not cause benthic algae to reach nuisance levels, or dissolved oxygen concentrations to fall below applicable state water quality standards”? Specifically, the inquiry called for the use of a water quality model to link stressors with responses and to establish relationships between nutrient concentrations and eutrophication concerns (e.g., DO, pH, benthic algae, etc.). At the core of any model would be its data. The data for the Q2K modeling effort is expounded upon in this section.

6.1 Summary of Field Data Collection to Support Modeling

A comprehensive field measurement program was initiated in 2007 to support the modeling. This is described in detail in the attached Quality Assurance Project Plan (QAPP) and Sampling and Analysis Plan (SAP) (**Appendix A**). A cursory review is presented here so that the reader does not have to refer back to the Appendix.

Two synoptic river surveys were initiated during the summer of 2007 (August and September) to support model development. Collections were made for the purpose of providing research quality data for the model and the following was characterized: water column chemistry and site biology; real-time water quality field parameters (using YSI sondes); meteorological data; mainstem and tributary streamflow records; sediment oxygen demand (SOD); river productivity and respiration rates, and time of travel. The data collection took place during two separate 10-day periods in both August and September respectively (e.g., water samples, algal collections, rate measurements, etc.). All activities were carried out under the direction of the DEQ Quality Assurance (QA) program.

YSI sondes were deployed and maintained throughout the summer (approximately 2 months). Eight main-stem river sites and over a dozen tributaries/irrigation return flows were monitored. The following locations were of interest: (1) the Rosebud West FAS (at Forsyth, MT) to the Cartersville Canal return flow, (2) Cartersville Canal return flow to the 1902 Bridge (near Miles City, MT); (3) 1902 Bridge to the Kinsey Bridge FAS, (4) Kinsey Bridge FAS to the Powder River (near Terry, MT); (5) Powder River to Calypso Bridge, (6) Calypso Bridge to O’Fallon Creek, and (7) O’Fallon Creek to the Bell Street Bridge (at Glendive, MT). Sampling locations were shown previously in **Figure 4-2** and are in accordance with Mills, et al., (1986) and Barnwell, et al., (2004). Full details are described in **Appendix A**.

6.2 Data Compilation and Supporting Information

A data compilation was undertaken to fill data gaps and provide supporting information for the model. An overview of this work is described in this section.

6.2.1 Sources

Sources of streamflow, climatic, and physical feature data used in the project are shown in **Table 6-1**. Streamflow records were acquired from the USGS via their National Water Information System (NWIS) (USGS, 2008) and were stored in Watershed Data Management (WDM) files for processing (Hummel, et

1 al., 2001). Water quality and chemistry data were retrieved from NWIS (USGS, 2008) and were
 2 combined with data from EPA’s STORage and RETRetrieval (STORET) database (EPA, 2008b). These were
 3 archived into a Microsoft Access™ project database. Records were also pulled from the Integrated
 4 Compliance Information System (ICIS) (EPA, 2010c), Ground Water Information Center (GWIC) (MBMG,
 5 2008), and USGS National Water Quality Assessment (NAWQA) database. They were stored in their
 6 original format.

7
 8 Climatic data for the project were obtained from the National Climatic Data Center (NCDC) (NOAA,
 9 2009), Great Plains AgriMET Cooperative Agricultural Weather Network (BOR, 2009), and MesoWest
 10 (Mesowest, 2009). Supporting atmospheric information (CO₂ data, etc.) was also acquired from the
 11 Clean Air Status and Trends Network (CASTNET) (EPA, 2010a) and GlobalView-CO₂ (NOAA, 2010a)
 12 Planimetric data for Geographic Information System (GIS) analysis (including aerial photographs, river
 13 hydrography, bank lines, digital elevation model (DEM)/terrain data, and other features) were obtained
 14 from the Yellowstone River Corridor Resource Clearinghouse (NRIS, 2009). Data were saved in their
 15 original formats and were modified as the project necessitated.

16
 17 **Table 6-1. Data sources used in development of the Yellowstone River nutrient model.**

Type of data	Sources
Streamflow	USGS NWIS, http://waterdata.usgs.gov/nwis EPA STORET, http://www.epa.gov/storet ICIS, http://www.epa.gov/compliance/data/systems/icis GWIC, http://mbmggwic.mtech.edu/ BRID (available by hardcopy request only)
Climatic, Atmospheric	NWS, http://www.ncdc.noaa.gov/oa/ncdc.html BOR, http://www.usbr.gov/gp/agrimet MesoWest, http://mesowest.utah.edu/index.html EPACASTNET http://www.epa.gov/castnet/sites/thr422.html GLOBALVIEW-CO2 http://www.esrl.noaa.gov/gmd/ccgg/globalview/co2/co2_intro.html
Water quality	NWIS, STORET, ICIS (same as above)
Physical Features	Yellowstone River Corridor Resource Clearinghouse http://nris.mt.gov/yellowstone

18
 19 **6.2.2 Personal Communications and Supporting Data**

20
 21 Data were also acquired through a number of direct personal communications. These included contact
 22 with (in alphabetical order): Army Corps of Engineers (ACOE, L. Hamilton, personal communication, Oct.
 23 2, 2009); Bureau of Reclamation (BOR, D. Critelli, personal communication, Jul. 10, 2009 and T. Grove,
 24 personal communication, May 21, 2009); Buffalo Rapids Irrigation District (BRID, D. Schwarz, personal
 25 communication May 19, 2008); City of Forsyth, MT (P. Zent, personal communication Dec. 17, 2009);
 26 City of Miles City (A. Kelm, personal communication, May 23, 2008); Department of Natural Resources
 27 and Conservation (DNRC, L. Dolan, personal communication, Dec. 23, 2009 and T. Blandford, personal
 28 communication Jan. 6, 2010); Montana Bureau of Mines and Geology (MBMG, J. LaFave, personal
 29 communication, Mar. 24, 2010), Montana Department of Transportation (MDOT, B. Hamilton, personal
 30 communication Aug. 18, 2008); Montana State University (MSU; H. Sessoms, personal communication,
 31 Sept. 9, 2008); National Weather Service (NWS, J. Branda, personal communication Aug. 13, 2008); USGS
 32 (M. White, personal communication Mar. 30, 2009 and D. Peterson, personal communication Jan. 19,

1 2009); and the U.S. Range & Livestock experiment station (K. Molley, personal communication Jun. 3,
2 2008). DEQ maintains these communication records in our project logs.

3

4 **6.2.3 Database**

5

6 Attributes of the database used in the data compilation are shown below. Sites on the main-stem river
7 with sufficient records for characterization of water quality are identified in **Table 6-2**. Tributary sites are
8 shown in **Table 6-3**. Included is the location¹, site ID, constituent of interest, gaging or sampling history
9 and the number of independent observations. Only gaging records greater than 5 years and greater than
10 10 different sampling dates were included.

11

Table 6-2. Main-stem water quality stations on the Yellowstone River with sufficient data.

Site Location	USGS Site ID	DEQ Site ID(s)	Constituent	Number of Obs.	Period of Record
Laurel	06205200	2659YE03, 2659YE01, Y06YSR400, Y06YSR395, Y06YELSR01	Flow	none	n/a
			Climate/Air	134	n/a
			Total N	132	1974-2007
			Ammonia (NH ₃)	56	1974-2007
			NO ₂ +NO ₃	181	1975-2007
			Total P	59	1974-2007
			SRP	95	1974-2007
			Solids	2	1974-2007
			Algae (either)	yes	2007
			Feature		2001,2004
Billings	06214500	Y06YSR470, Y06YSR520, Y12YSR550, Y12YSR549	Flow	daily	1928-2008
			Climate/Air	hourly	1935-2008
			Total N	172	1967-2001
			Ammonia (NH ₃)	202	1969-2001
			NO ₂ +NO ₃	160	1971-2001
			Total P	180	1969-2003
			SRP	138	1970-2001
			Solids	189	1965-2003
			Algae (either)	13	1975-2000
			Feature	yes	2001,2004

¹ Location was considered the same if within two kilometers of one another, and no incoming tributaries, point sources, etc. were identified between each.

Table 6-2. Main-stem water quality stations on the Yellowstone River with sufficient data.

Site Location	USGS Site ID	DEQ Site ID(s)	Constituent	Number of Obs.	Period of Record
Forsyth	06295000	Y17YELSR09	Flow Climate/Air Total N Ammonia (NH ₃) NO ₂ +NO ₃ Total P SRP Solids Algae (either) Feature	daily hourly 176 181 99 197 103 184 19 yes	1977-2008 1998-2008 1974-2007 1974-2007 1974-2007 1974-2007 1973-2007 1975-2007 1978-2007 2001,2007
Miles City	06296120 06309000 (flow)	Y17YELSR01, 3682YE01, 3682YE02	Flow Climate/Air Total N Ammonia (NH ₃) NO ₂ +NO ₃ Total P SRP Solids Algae (either) Feature	daily hourly 184 188 134 214 136 127 13 yes	1946-2008 1936-2008 1974-2007 1974-2007 1971-2007 1974-2007 1971-2007 1965-2007 1975-2007 2001,2007
Terry	06326530	4086YE01, Y23YELLR02, Y23YELLR03	Flow Climate/Air Total N Ammonia (NH ₃) NO ₂ +NO ₃ Total P SRP Solids Algae (either) Feature	16 hourly 109 112 19 122 20 103 14 yes	1974-1979 1998-2008 1974-2007 1974-2007 1974-2007 1974-2007 1974-2007 1975-2007 1975-2007 2001,2007
Glendive	06327500	4490YE01, Y23YELLR04	Flow Climate/Air Total N Ammonia (NH ₃) NO ₂ +NO ₃ Total P SRP Solids Algae (either) Feature	daily hourly 2 2 16 14 17 9 4 yes	2002-2008 1973-2008 2007 2007 1976-2007 1976-2007 1973-2007 1975-2007 2007 2001,2004

Table 6-2. Main-stem water quality stations on the Yellowstone River with sufficient data.

Site Location	USGS Site ID	DEQ Site ID(s)	Constituent	Number of Obs.	Period of Record
Sidney	06329500	NA	Flow	daily	1933-2008
			Climate/Air	hourly	1973-2008
			Total N	333	1970-2007
			Ammonia (NH ₃)	468	1969-2007
			NO ₂ +NO ₃	281	1971-2007
			Total P	426	1969-2007
			SRP	272	1971-2007
			Solids	427	1965-2008
			Algae (either)	10	1975-2005
			Feature	yes	2001,2004

1

Table 6-3. Major tributary water quality stations with sufficient data.

Location	USGS Site ID	DEQ Site ID (s)	Constituent	Number of Obs.	Period of Record
Rosebud Creek	06296003	Y14ROSBC01, Y14ROSBC04, Y14ROSBC05, Y17ROSEC01	Flow	daily	1974-2006
			Total N	108	1975-2007
			Ammonia (NH ₃)	133	1975-2007
			NO ₂ +NO ₃	44	1975-2007
			Total P	154	1975-2007
			SRP	56	1974-2007
			Solids	169	1974-2007
			Algae (either)	0	n/a
			Feature	no	n/a
			Tongue River	06308500	Y16TONGR02, Y16TONGR03, Y16TR99, Y17TONGR01
Total N	158	1974-2008			
Ammonia (NH ₃)	195	1974-2008			
NO ₂ +NO ₃	177	1971-2008			
Total P	203	1971-2008			
SRP	158	1971-2008			
Solids	246	1974-2007			
Algae (either)	0	n/a			
Feature	0	n/a			
Powder River	06326520 06326500 (flow)	3985PO01, 3985PO02, Y21PR40, Y21PWDRR01, Y21PWDRR02			
			Total N	229	1974-2008
			Ammonia (NH ₃)	293	1977-2008
			NO ₂ +NO ₃	234	1975-2008
			Total P	285	1974-2008
			SRP	212	1973-2008
			Solids	323	1965-2008
			Algae (either)	11	2000-2003
			Feature	0	n/a

Table 6-3. Major tributary water quality stations with sufficient data.

Location	USGS Site ID	DEQ Site ID (s)	Constituent	Number of Obs.	Period of Record
O’Fallon Creek	06326600	3989OF01, 4087OF01, Y22OFALC16, Y22OFALC08, Y22OFALC13	Flow	Daily	1977-1992
			Total N	46	1977-2007
			Ammonia (NH ₃)	59	1977-2007
			NO ₂ +NO ₃	23	1975-2007
			Total P	61	1977-2007
			SRP	16	1973-2007
			Solids	76	1975-2007
			Algae (either)	0	n/a
			Feature	0	n/a

1

6.3 Data Analysis

2

3

4

5

6

7

8

9

10

11

12

13

14

15

The sites identified previously (**Section 6.2**) were analyzed so that long term statistical information such as estimates of central tendency (i.e., mean or median concentrations), variances, and distributions could be ascertained. This allowed us to fill data gaps, draw conclusions from historical data, and better understand relational information about the river. Two examples are provided in this section. Similar comparisons are in the rest of the document.

In **Figure 6-1**, a compilation of total nitrogen (TN) and total phosphorus (TP) for each of the mainstem river sites is shown (e.g. Laurel, Billings, Forsyth, Miles City, Terry, Glendive, and Sidney). While there is considerable variability in the data, nutrient concentrations clearly tend to go up in the downstream direction. They also far exceed suggested TN and TP Level III Ecoregion nutrient criteria (even at the 25th percentile).

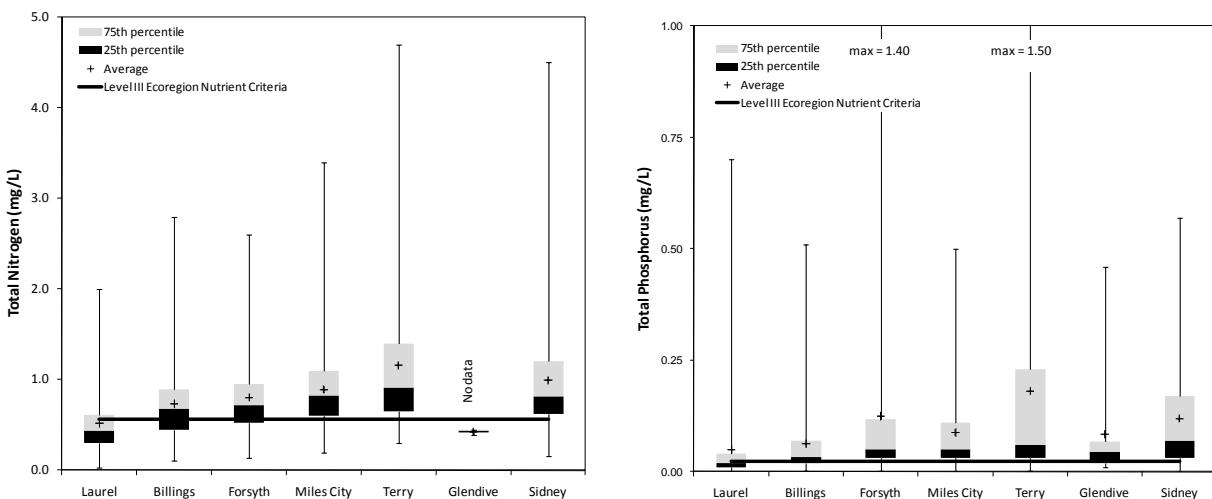

16

Figure 6-1. Historical nutrient concentrations in the lower Yellowstone River.

17

18

19

20

(Left panel) Historical TN data on the Yellowstone River. (Right panel). Same but for TP. Data are shown over the period of record for each site (1969-2007), and in both instances, are well above the Level III ecoregional criteria (560 $\mu\text{g L}^{-1}$ TN or 23 $\mu\text{g L}^{-1}$ TP) proposed by EPA (2001).

1 In **Figure 6-2**, diurnal dissolved oxygen (DO) data were evaluated. Measurements from different
 2 locations and diel cycles during the month of August were compared (Klarich, 1976; Montana Board of
 3 Health, 1967; Peterson, et al., 2001) and show good agreement between DO percent saturation in all
 4 years (**Figure 6-2**, left). This suggests that DO saturation in all studies, irrespective of the flow condition
 5 or even decade collected, is similar. It also demonstrates that our selection of a steady-state model is a
 6 reasonable choice as nearly all of the data falls within the $\pm 10\%$ fitted saturation curve.
 7
 8 Dissolved oxygen shows a fairly consistent longitudinal tendency in the river (**Figure 6-2**, right). Daily
 9 diurnal DO flux (i.e., maximum daily DO minus minimum daily DO) is typically higher in the upper
 10 reaches of the river near Billings (i.e., more productive) and then diminishes in the downstream
 11 direction. Findings are consistent with Peterson and Porter (2002), as well as our observations, where
 12 longitudinal increases in turbidity influence productivity. Data again are fairly consistent and again fall
 13 within the $\pm 10\%$ envelope identified previously.

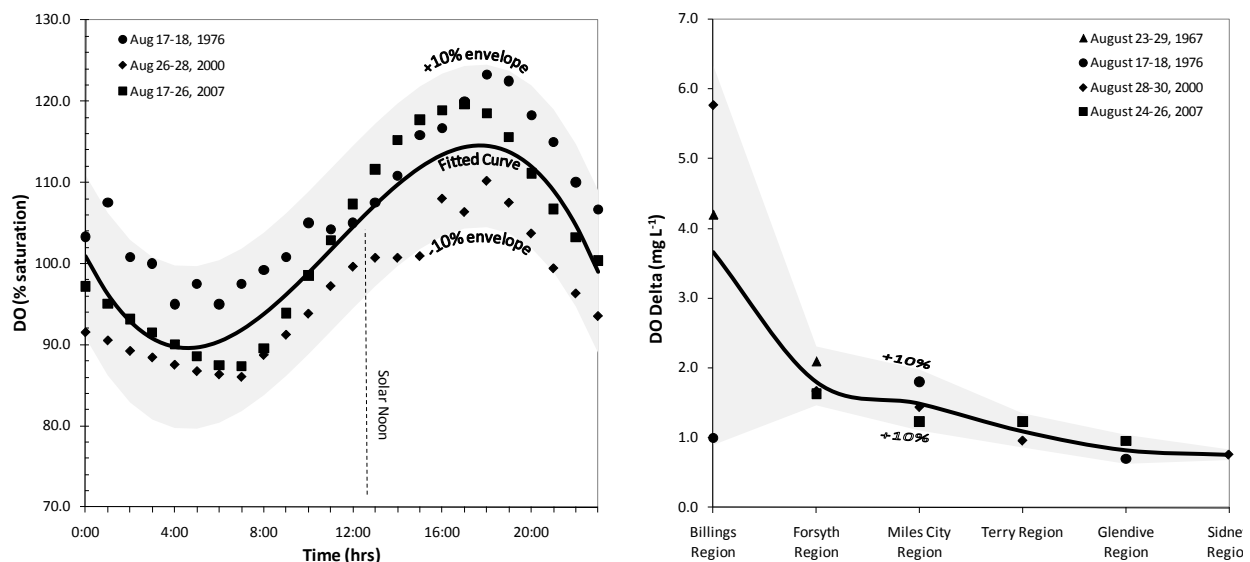

14
 15 **Figure 6- 2. Dissolved oxygen data on the Yellowstone River for August 1967, 1976, 2000, and 2007.**
 16 (Left panel) Typical diurnal pattern at Forsyth, MT over the August 1976, 2000, and 2007 period. A fitted curve is
 17 shown along with as $\pm 10\%$ saturation envelope. (Right panel) Longitudinal diurnal fluctuation in DO (i.e. max-min)
 18 over all years. Envelope shown as $\pm 10\%$ of the reported maximum or minima.

19

20 6.4 Outside Studies Useful for Modeling

21

22 Among the studies identified in **Section 6.2**, one was particularly of use because it had all of the
 23 necessary data for model development (e.g., water chemistry data, diurnal field parameters, and
 24 benthic and floating algae). This information was collected as part of the USGS National Water Quality
 25 Assessment (NAWQA) program (Peterson, et al., 2001), and was quite comparable to the DEQ effort.
 26 Attributes of these two independent measurement programs are compared in **Table 6-4** and **Table 6-5**.
 27 They provide a good basis for which to make comparisons for August low-flow river conditions.

28

29

30

31

32

1 **Table 6-4. Data collection matrix for the DEQ 2007 and USGS 2000 monitoring programs.**

2 Comparisons between the USGS 2000 and DEQ 2007 effort.

Monitoring Location ¹	Climate	Streamflow	Water Chemistry ²	Diurnal WQ ³	Transport ⁴	Kinetics ⁵	Benthics ⁶	Light ⁷
Yellowstone River at Laurel			U				U	U
Yellowstone River at Billings		U	U	U	U		U	U
Yellowstone River at Custer				U	U			U
Yellowstone River at/near Forsyth		U	D,U	D,U			U	U
- Forsyth WWTP		D	D					
- Rosebud Creek		D	D					
Yellowstone River at Far West FAS			D		U	D	D	
Yellowstone River above Cartersville Canal			D	D				
Yellowstone River at/near Miles City	D	U	D,U	D,U	U	D	D,U	U
- Tongue River		D,U	D,U					
- Miles City WWTP		D	D					
Yellowstone River at Pirogue Island			D			D	D	
Yellowstone River below Pirogue Island			D	D				
Yellowstone River at Kinsey FAS			D	D	U			
Yellowstone River above Powder River			D	D		D	D	
- Powder River		D,U	D					
Yellowstone River at/near Terry			D	D,U	U		U	U
Yellowstone River above O'Fallon Creek			D	D	U	D	D	
- O'Fallon Creek		D	D					
Yellowstone River at Glendive		U	D,U	D	U		U	U
Yellowstone River at Sidney		U		U			U	U

3 ¹U = monitored by USGS in 2000 or 2008, D = monitored by DEQ in 20074 ²Equal width integrated (EWI) samples5 ³YSI model 6600EDS sonde or equivalent6 ⁴From USGS dye-tracer study in 20087 ⁵Productivity using light-dark bottles; reaeration using delta method (Chapra and Di Toro, 1991a).8 ⁶Benthic algae and SOD9 ⁷Photosynthetically active radiation (PAR) at depth

10

11

12

13

14

15

16

17

18

1 **Table 6-5. Water chemistry comparisons for the DEQ 2007 and USGS 2000 data programs.**

Constituent ¹	Mainstem	Point Source	Tributary	Irrigation
Total Nitrogen	D,U	D	D,U	D
Nitrate plus Nitrite (NO ₂ ⁻ +NO ₃ ⁻)	D,U	D	D,U	D
Ammonia (NH ₄ ⁺)	D,U	D	D,U	D
Total Phosphours	D,U	D	D,U	D
Soluble Reactive Phosphorus (SRP)	D,U	D	D,U	D
Total Suspended Solids (TSS)	D,U	D	D,U	D
Volatile Suspended Soils (VSS)	D	D	D	D
CBOD5-day	D	D		
Seston Stoichiometry	D			
Phytoplankton	D,U		U	

¹U = monitored by USGS in 2000, D = monitored by DEQ in 2007.

2
3
4 Ambient conditions during these two periods are shown in **Figure 6-3**. Both climate (as represented by
5 mean daily air temperature and precipitation) and streamflow (as annual hydrograph) compared
6 favorably during both studies. The meteorological conditions were very similar to that of the 1970-2001
7 climate normals (NOAA, 2009) and streamflow was well below average both years; between the 5th and
8 25th percentile. This is roughly equivalent to somewhere between a 10 and 20 year low-flow condition
9 (McCarthy, 2004).

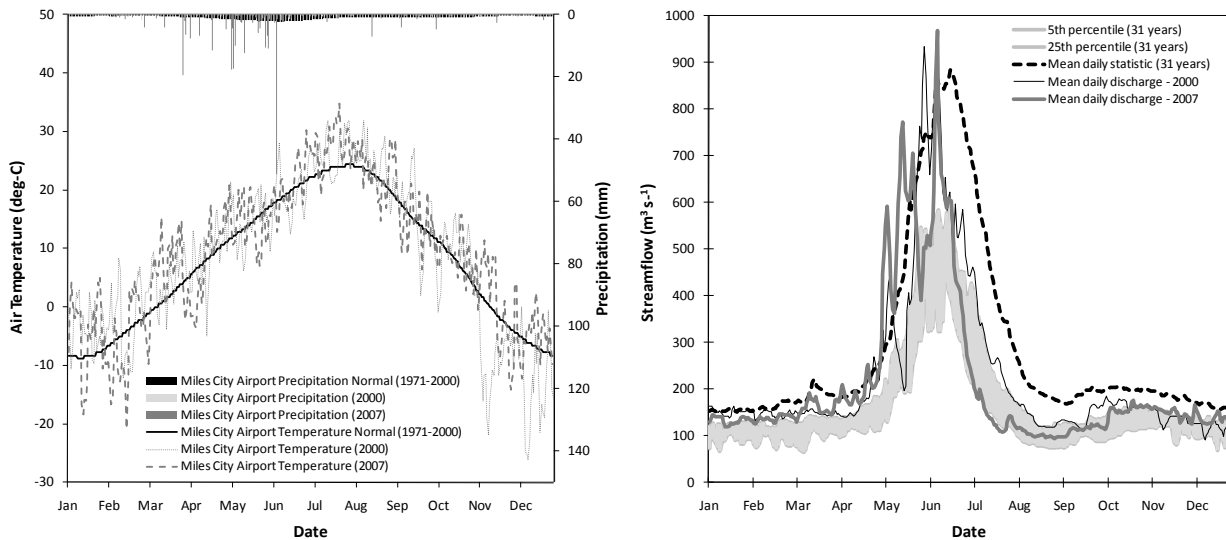

11 **Figure 6-3. Conditions encountered during the 2000 and 2007 field data collection efforts.**
12 (Left panel) Climatological data. (Right panel) Streamflow hydrology.

13
14
15 Comparative water quality results for each period (August 2000, August 2007, and September 2007) are
16 shown in **Table 6**. Conditions were similar both years (e.g., temperature, DO, SC, pH), with the exception
17 of TSS, phytoplankton, soluble N (NO₂+NO₃), and temperature. Overall, September differed from the
18 three periods as temperature was approximately 4-5°C cooler and phytoplankton concentrations were
19 about half of the other time-frames.

1 **Table 6-6. Summary of water quality data during the 2000 and 2007 field data collection efforts.**

Location and Monitoring Period	Temperature (°C)	pH	SC ($\mu\text{S cm}^{-1}$)	DO (mg L^{-1})	Turbidity (ntu)	TSS (mg/L)	TN (mg L^{-1})	NO ₂ +NO ₃ (mg L^{-1})	TP (mg L^{-1})	SRP (mg L^{-1})	Phyto ($\mu\text{g L}^{-1}$)
Forsyth											
Aug. 2000	21.4	8.55	673	7.05	6.4	18 ¹	0.39	<0.05	0.031	<0.01	6.9
Aug. 2007	20.8	8.58	767	8.06	28	31	0.51	0.104	0.042	<0.004	8.8
Sept. 2007	16.2	8.65	693	8.97	14	20	0.47	0.144	0.040	0.003	3.9
Miles City											
Aug. 2000	20.4	8.58	692	7.91	13	23	0.32	<0.05	0.029	<0.01	6.0
Aug. 2007	21.6	8.72	731	9.01	17	31	0.46	0.003	0.051	<0.004	11.2
Sept. 2007	16.7	8.74	695	9.32	15	42	0.46	0.069	0.046	<0.004	3.7
Terry ²											
Aug. 2000	18.1	8.58	660	8.37	12	23	0.39	<0.05	0.037	<0.01	5.3
Aug. 2007	21.2	8.55	771	8.76	17	32	0.45	0.002	0.045	<0.004	11.2
Sept. 2007	16.5	8.60	655	9.65	25	26	0.34	0.018	0.034	<0.004	4.8
Glendive ³											
Aug. 2000	20.0	8.42	739	8.05	19	30	0.39	<0.05	0.038	<0.01	5.7
Aug. 2007	20.7	8.42	822	8.24	38	51	0.44	0.006	0.057	<0.004	15.6
Sept. 2007 ⁴	16.2	8.45	772	8.96	25	107	0.45	0.014	0.045	<0.004	12.1

2 ¹Two values reported, 8/18/2000 TSS = 18 mg L^{-1} , 8/26/2000 TSS = 58 mg L^{-1} .

3 ²Diurnal data at Terry collected in September 2000.

4 ³No diurnal data collected at Glendive, substitute Sidney observations.

5 ⁴Grab sample (no EWV), suggestive of why the data is so different.

6

7 **6.5 Other Pertinent Information**

8

9 A considerable amount of other work has been completed on the Yellowstone River; far more than can
10 adequately be addressed in this document. Unfortunately, most of this information is incapable of
11 supporting water quality modeling directly. For example, Knudson and Swanson (1976) measured diel
12 dissolved oxygen at a number of sites in August of 1976, but not water chemistry. The Montana Board of
13 Health (Montana Board of Health, 1952; Montana Board of Health, 1956) did significant work on the
14 river in August and September of 1952 and 1955 including substantial water quality data collections,
15 however, the analytical results were of poor resolution due to the laboratory methods available at the
16 time. Diurnal data was not taken either. Lastly, many efforts have been completed mainly in the Billings
17 region (Bahls, 1976a; Karp, et al., 1977; Montana Board of Health, 1967). While these contain very good
18 information concerning the river, it is not clear whether they have direct relation to our study area. Plus
19 they are absent of many of the necessary data requirements anyway.

20

21 The work identified previously, along with any not specifically mentioned here but perhaps cited in
22 other parts our report, provide useful information to support the modeling, but do not directly aid in
23 model development. Their utility lies in such things as filling data gaps, estimating model rates, or
24 deriving an understanding of water quality responses.

6.6 Data Quality, Detection Limits, and Significant Figures

Quality assessments of all data sources mentioned previously were completed to the extent possible by DEQ. This included: standard DEQ quality checks to evaluate information against historical conditions, performing station comparisons, time-series validation, and checks for data outliers. These revealed correctable laboratory errors and other minor inconsistencies in the data. Overall though, the data were generally of good quality. In instances where analytical detection limits were an issue (i.e., non-detect laboratory values), $\frac{1}{2}$ the detection limit was used. Rounding and other significant-figure use conventions were also applied as outlined in Section 1050B of American Public Health Association (APHA, 2005). Data flags were considered on a case-by-case basis, and outliers were verified prior to use. For time-series, if there were minor periods of missing data or errant data, these were filled using standard scientific procedures such as the normal-ratio method (Linsley, et al., 1982). If no suitable replacement data could be established, data were excluded altogether. Centrally tendency statistics were reported as geometric means, or medians, rather than averages to eliminate right data skew (i.e., lognormally distributed data).

1

7.0 MODEL SETUP AND DEVELOPMENT

This section identifies the physical attributes used in the Yellowstone River model setup and development. Included are things such as centerline flow path delineation, mass transfer locations, transport mechanisms, and air and water boundary interactions. General data types or sources used to define these inputs (**Table 7-1**) are described in the following sections.

Table 7-1. Data sources used in the lower Yellowstone River QUAL2K model development.

Data Type	Source(s)	Increment
Flow Path	1. Air photo assessment and lower Yellowstone River digitized centerline (AGDTM, 2004)	n/a
Streamflow	1. DEQ field observations 2. U.S. Geological Survey gaging stations 3. Buffalo Rapids Irrigation District pumping rates 4. DNRC Water Resource Surveys	Instantaneous Daily Daily n/a
Transport	1. DEQ field observations 2. U.S. Geological Survey travel time study; rating measurements	Instantaneous Hourly
Climate	1. Bureau of Reclamation AgriMET stations (Terry & Glendive) 2. DEQ weather station (Miles City) 3. Montana Department of Transportation Road Weather Information System station (RWIS) 4. National Weather Service stations (NOAA)	15-minute 15-minute varies hourly
Shade	1. DEQ shade analysis with Shadev3.0 model	hourly
Other boundary conditions (quality/quantity)	1. DEQ field observations 2. USGS field measurements	Instantaneous Instantaneous

7.1 Flow Path (Centerline) Definition

Aerial photography was used to define the low-flow centerline and establish gradient in the model. A number of aerial photo flights have been made on the river (**Table 7-2**) and we used the 2001 color-infrared (IR) flight as it was most similar to field conditions encountered during 2007 (from a hydrologic standpoint). The length was also already digitized (AGDTM, 2004), which was an added advantage.

Table 7-2. Aerial photography summary of the lower Yellowstone River.

Photo Series	Source	Photo Date(s)	Flow at Miles City (m^3s^{-1})	Gage Height (m)
2001 Color Infrared (IR)	NRCS	Aug. 3-5, 2001	107-121	0.79-0.85
2004/2007 Color Floodplain Mapping	LYRCC	Jul. 12 – Aug. 5, 2005	159-168	0.98-1.00
2005 NAIP	NAIP	Oct. 15 – Nov. 2, 2007	159-496	0.98-1.80
Field Conditions 2007	-----	-----	106-120	0.79-0.85

The channel length and associated river stationing (in kilometers) used in the modeling is shown in **Table 7-3**. Ascribed values make an excellent comparison against previous efforts by the Department of Natural Resources and Conservation (DNRC, 1976) and a separate DEQ quality assurance (QA) check

1 with the 2007 National Agriculture Imagery Program (NAIP) photography. The length (and associated
 2 stationing) influences the placement of model features such as incoming tributaries or point or non-
 3 point source withdrawals, and calibration locations. The overall difference between the three efforts is
 4 less than 1%. Thus we feel confident about our length estimate.

5
 6 **Table 7-3. Representative flow path lengths of the lower Yellowstone River.**

7 River stationing is based on distance downstream from the headwater boundary condition which in this case was
 8 Forsyth. Glendive was at the lower end of the study reach, 232.9 km from the origin.

Reach	2001 color- IR (km)	DNRC, 1976 (km)	DEQ QA, 2007 (km)
Forsyth to Rosebud Creek	22.6	22.0	22.8
Rosebud Creek to Tongue River	65.3	64.9	66.0
Tongue River to Powder River	57.7	55.8	56.8
Powder River to O'Fallon Creek	32.2	32.2	32.6
O'Fallon Creek to Glendive	55.1	59.7	57.1
Total Length	232.9	234.6	235.3

9
 10 Gradient is also a necessary input for Q2K and station and elevation information were determined with
 11 centerline described previously using a digital elevation model (DEM) of the project site¹. ArcGIS TTools
 12 (Boyd and Kasper, 2003) was used to complete elevation sampling every 100-meters along the channel
 13 centerline and the results are shown in **Figure 7-1**. Overall, the profile is fairly consistent from Forsyth to
 14 Miles City (km 232 to 140), breaks between Miles City and Terry (river station 140 to 100 km), and then
 15 approximates prior conditions from Terry to Glendive (km 100-0). From review of the profile, 31 unique
 16 hydraulic reaches were identified for use in Q2K which included major slope breaks, breaks at
 17 tributaries, or rapids. These were picked out visually by DEQ, or were identified in other documents
 18 related to the morphology of the river (AGDTM, 2004). The rapids occurred at river kilometers 130, 125,
 19 95, and 80, and are discussed in more detail in **Section 7.3**.

20
 21 Lastly, aerial photography was used to determine additional channel properties including mean channel
 22 wetted width, bankfull width, etc. This information is described in more detail in **Section 7.3** as well as
 23 **Appendix C**. Values were averaged over 1-km increments to make reach specific estimates.

24

¹ The DEM was developed using light detection and ranging (LIDAR) data and channel bathymetric surveys from 2004 and 2007. Coordinate system and datum used for this effort were State-Plane NAD83 and NAVD88. Raw triangular irregular network (TIN) files were taken from the NRIS (NRIS, Montana Natural Resource Information System, 2009) and were converted to 2.5 meter resolution DEM which were subsequently mosaiced into a single contiguous DEM of the project site (from slightly upstream of Forsyth to downstream of Glendive). This included the addition of elevation data outside of the LIDAR and bathymetric survey area using the 10 m National Elevation Dataset (NED). The area where the bathymetric survey was completed in the lower river was smoothed to remove the undulating bed profile. (see **Figure 7-1**).

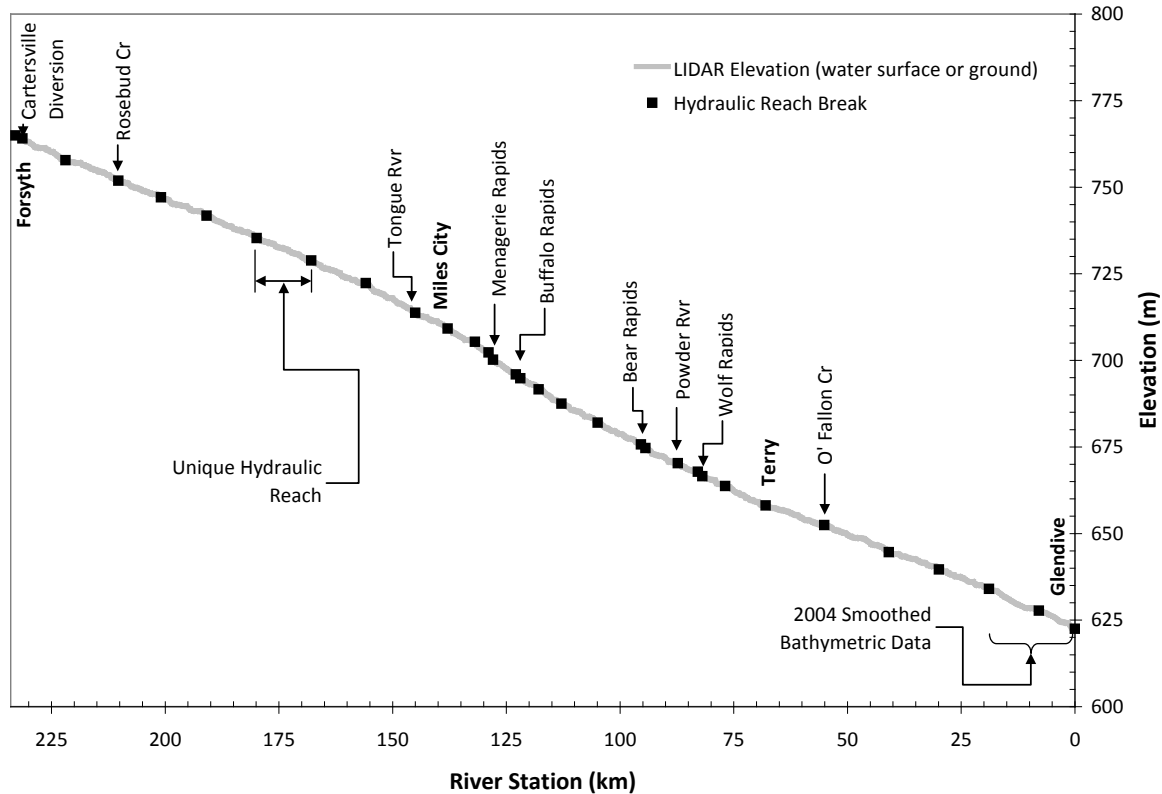

1
2 **Figure 7-1. Longitudinal profile of the Yellowstone River.**

3 Estimated from 2.5 meter DEM of the project site (see previous footnote for details on the DEM). Thirty-one
4 hydraulic reaches were defined based on subtle changes in gradient. This included identification of several rapids
5 in the project site.
6

7 **7.2 Streamflow**

8
9 A steady-state streamflow balance was used according to **Equation 7-1** to represent flow in the model,
10 where outflow of a gaged segment in $\text{m}^3 \text{s}^{-1}$ ($Q_{\text{gage},i}$) was equal to the sum of in the inflow from the
11 upstream gage ($Q_{\text{gage},i-1}$), plus or less any point source or diffuse inflows ($Q_{\text{in},j}$) or abstractions ($Q_{\text{ab},j}$).
12

13 **(Equation 7-1)**
$$Q_{\text{gage},i} = Q_{\text{gage},i-1} + Q_{\text{in},i} - Q_{\text{ab},i}$$

14
15 Meaningful input to **Equation 7-1** was provided from the 2007 field effort which was a collective effort
16 from a number of agencies and organizations. Those who contributed to its development included DEQ,
17 USGS, and the Buffalo Rapids Irrigation District (BRID). Sources, details, and assumptions regarding the
18 streamflow water balance development are described in subsequent sections. A ten day average
19 streamflow condition was used which reflects the time over which the water quality samples were
20 collected.
21

22 **7.2.1 Surface Water Summary**

23
24 Aspects of the surface water balance are detailed below and entail any water that could be measured in
25 flowing channels.

7.2.1.1 Mainstem River Flow

Mainstem river flows were used to constrain $Q_{\text{gage},i}$ and $Q_{\text{gage},i-1}$ in **Equation 7-1** and were taken from mean daily flows reported by USGS for the three active gages on the river: USGS 06295000 Yellowstone River at Forsyth, USGS 06309000 Yellowstone River at Miles City, and USGS 06327500 Yellowstone River at Glendive. Flows for these gages during the summer 2007 are shown in **Figure 7-2** (left). Conditions were primarily steady-state during the 10-day data collection period as indicated by an average coefficient of variation of 2.5% and 1.8% for August and September respectively. Correlations between gage sites were good ($r^2 > 0.90$), with the exception of Glendive in early August. During this period irrigation varied between the gages and changed the ratio at various locations in the river. Transient conditions occurred only once (in September), defined by variation of greater than 10% per week. The shift was related to precipitation in the upper basin, cooler fall temperatures, and reductions in irrigation throughout the watershed. As identified previously, flows were quite low, between a seasonal 10- to 20-year low-flow condition (**Table 7-4**) which was taken directly out of McCarthy (2004).

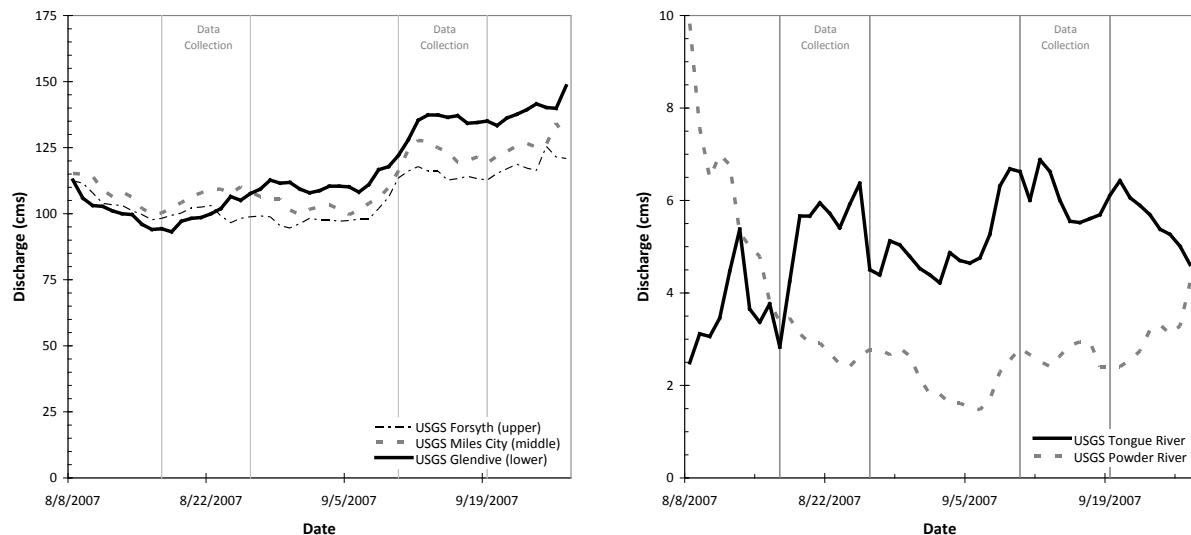

Figure 7-2. Surface water summary for the lower Yellowstone River during 2007.

(Left panel) Streamflow on the mainstem river for USGS 06295000 Yellowstone River at Forsyth (upper reach), USGS 06309000 Yellowstone River at Miles City (middle reach), and USGS 06327500 Yellowstone River at Glendive (lower reach). (Right panel) Streamflow but for the major gaged tributaries, which include USGS 06308500 Tongue River at Miles City and USGS 06326500 Powder River near Locate.

1 **Table 7-4. Magnitude and probability of seasonal low flow for the Yellowstone River.**
 2 Data shown for the July-October seasonal low-flow period at USGS 06309000 Yellowstone River at Miles City¹. For
 3 comparative purposes, flows during 2007 were approximately $100 \text{ m}^3 \text{ s}^{-1}$.

Period of consecutive days	Discharge in $\text{m}^3 \text{ s}^{-1}$ for indicated recurrence interval (yrs) and non-exceedance probability (%)			
	2	5	10	20
recurrence interval	2	5	10	20
non-exceedance probability	50%	20%	10%	5%
1	169	126	106	90
3	173	128	107	91
7	177	131	109	93
14	183	135	112	94
30	194	142	118	99

4 ¹Taken from McCarthy (2004) over 36 seasons of record.
 5

6 **7.2.1.2 Tributary Flow**

7
 8 Tributary flow to the Yellowstone River was included as part of the $Q_{in,j}$ in the water balance. It was
 9 somewhat more variable than that of the mainstem river and hydrographs for the Tongue and Powder
 10 rivers (which are the two major contributors to the lower Yellowstone River) are shown in **Figure 7-2**
 11 (right). The Powder River exhibited somewhat oscillatory but stable streamflow over the summer period
 12 with a coefficient of variation (COV) of 7.5% and 9.0% for August and September respectively. The
 13 Tongue River is reservoir regulated, and shows distinct operational shifts and somewhat higher COVs
 14 (10.4% and 9.3% respectively). Since both waterbodies comprise a very small percentage of the overall
 15 streamflow to the river (e.g., less than 5% each), their overall influence is minimal.
 16

17 Other inflows or outflows of potential significance were also integrated to better describe the hydrologic
 18 regime of the watershed. These measurements are shown in **Table 7-5** and were made by either boat,
 19 or wading, and with a Marsh-McBirney Model 2000 Flo-Mate solid state current meter (Rantz, 1982).
 20 Actual discharge measurement forms are located in **Appendix B**.
 21

22 **Table 7-5. Instantaneous field measurements completed by Montana DEQ during 2007.**

Site	August Measured Flow ($\text{m}^3 \text{ s}^{-1}$)	September Measured Flow ($\text{m}^3 \text{ s}^{-1}$)	Change (%)
Cartersville Canal diversion	5.701	5.227	-8%
Forsyth WWTP	0.006	0.009	50%
Rosebud Creek	0.180	0.122	-32%
Cartersville Canal return flow	1.987	1.330	-33%
Tongue River ¹	3.822	6.037	58%
Kinsey Canal diversion	2.592	2.650	2%
Kinsey Canal return flow	0.101	0.791	683%
Shirley Canal return flow	0.500	0.461	-8%
Powder River	3.093	2.235	-28%
O'Fallon Creek	0.101	0.166	64%

23 ¹QA check completed for this site with USGS mean daily reported streamflow.

7.2.1.3 Unmeasured tributaries

Over 80 tributaries contribute to the lower Yellowstone River between Forsyth and Glendive (DNRC, Montana Department of Natural Resources and Conservation, 1976). These range in area from a few square kilometers to over 33,000 km² which is problematic in that the sheer number alone would preclude effective monitoring for modeling. As a result, DEQ monitored only the largest ones (e.g., those $\geq 3,000$ km², as described in the previous section) and estimated the rest through regression analysis (termed here ‘unmeasured tributaries’).

Twelve previously gaged sites (USGS, 2008) in the study area were used in to develop a flow vs. drainage area regression relationship. Mean streamflow (m³ s⁻¹) for the month of August or the month of September (as applicable to the calibration and validation models) was regressed against drainage area (km²) to determine the net contribution of inflow from ungaged sites. These estimates were then corrected to 2007 conditions based on the ratio of the mean monthly flow to that of flow during 2007. Sites used in linear regression model development are shown in **Table 7-6**.

The regressions developed in this exercise provided a good fit ($r^2 > 0.90$, see **Appendix B**) and were applied to the net unmonitored area between gage sites according to difference in reported area of each gage less any area accounted for by gaged tributaries¹. The net unmonitored tributary inflow to the Yellowstone River from this method was small, approximately 1.243 and 1.119 m³ s⁻¹ during August and September respectively (or 1.2 and 1.0% of the overall headwater boundary condition).

Table 7-6. Sites used in estimation of unmonitored tributaries.

Data taken from NWIS (accessed 9/22-23, 2008).

Site Id	Description	Drainage Area (km ²)	Period of Record
06296003	Rosebud Creek at mouth near Rosebud MT	3,371	1974-10 to 2006-09
06296100	Snell Creek near Hathaway MT	27	1981-10 to 1985-09
06308500	Tongue River near Miles City MT (pre-dam record)	11,751	1929-04 to 1932-09
06309075	Sunday Creek near Miles City MT	1848	1974-10 to 1984-09
06309079	Muster Creek near Kinsey MT	74	1978-03 to 1980-08
06309145	Custer Creek near Kinsey MT	391	1978-03 to 1980-08
06326500	Powder River near Locate MT	33,831	1938-03 to 2007-09
06326555	Cherry Creek near Terry MT	927	1979-09 to 1994-09
06326850	O'Fallon Creek at Mildred MT	3,614	1975-09 to 1978-09
06326952	Clear Creek near Lindsay MT	261	1982-03 to 1988-09
06327000	Upper Sevenmile Creek nr Glendive MT	NA	1921-03 to 1922-05
06327450	Cains Coulee at Glendive MT	10	1992-05 to 2004-09

¹ For example, the gaged area at Forsyth is 103,933 km² while at Miles City it is 124,921 km². Hence, the unaccounted area is 20,988 km². However, both Rosebud Creek (3,371 km²) and the Tongue River (13,972 km²) enter between these two gages. Thus the actual ungaged area is 3,645 km².

7.2.1.4 Municipalities

Domestic water withdrawals or wastewater treatment plant (WWTP) inflows were also incorporated (Table 7-7). Information was either directly measured in the field, provided by request from the discharger, or was retrieved from monthly reports of finished clearwell effluent or Montana Pollutant Discharge Elimination System (MPDES) discharge monitoring reports (DMRs).

Table 7-7. Municipal discharges in the lower Yellowstone River study reach during 2007.

Municipality	Type	Aug 17-26 Transfer ($\text{m}^3 \text{s}^{-1}$)	Sep 11-20 Transfer ($\text{m}^3 \text{s}^{-1}$)	Data Source or Comment ¹
City of Forsyth	Water Intake	-0.022	-0.017	Clearwell logs From City/Pat Zent
	WWTP Outfall	+0.011	+0.011	
City of Miles City	Water Intake	-0.102	-0.089	Clearwell logs From City/Allen Kelm
	WWTP Outfall	+0.052	+0.048	
City of Terry	WWTP Outfall	no discharge	+0.004	Field measured
Fallon-Prairie County	WWTP Outfall	no discharge	no discharge	N/A
City of Glendive	Water Intake	---	---	DS of study reach
	WWTP Outfall	---	---	DS of study reach

¹ Water intake data taken from monthly reports of finished clearwell effluent.

7.2.1.5 Irrigation

Large-scale irrigation exchanges ($Q_{ab,j}$ and $Q_{in,j}$, depending on inflow or outflow) were also incorporated because of their known influence on water quality (Law and Skogerboe, 1972; Miller, et al., 1978; Ongley, 1996). Major units were identified through review of historical DNRC Water Resource Surveys (WRS) and those believed to be of primary importance are identified in Table 7-8.

Table 7-8. Summary of major irrigation units on the lower Yellowstone River.

Irrigation Unit ¹	Irrigated Area at time of publication (hectares)	Maximum Irrigated Area (hectares)	County	Publication Date
Cartersville Irrigation District	3,651	4,243	Rosebud	1948
Baringer Pumping Project	380	467	Rosebud	1948
Private Irrigation (pumps from YR) ²	1,160	1,870	All	Various
T & Y Irrigation District (return flow) ²	3,598	4,077	Custer	1948
Kinsey Irrigation Company	2,511	2,827	Custer	1948
Shirley Unit - Buffalo Rapids	1,823	2,018	Custer	1948
Terry Unit-Buffalo Rapids	1,282	1,357	Prairie	1970
Fallon Unit – Buffalo Rapids	1,204	1,238	Prairie	1970
Glendive Unit – Buffalo Rapids	5,758	6,152	Prairie/Dawson	1970

¹ As described in the Water Resource Surveys.

² Data gap, estimated as described in next paragraph.

1 Despite our best efforts, we were unable to monitor all of the sites identified in **Table 7-8**. To make
 2 reasonable estimates for the missing information, a regression approach similar to that described for
 3 the tributaries was used. In this instance, regressions were carried out using maximum irrigated area (to
 4 characterize irrigation withdrawals and return flow) and results were fairly good ($r^2=0.91$ and 0.76) as
 5 shown in **Table 7-9**. The actual regression models are detailed in **Appendix B**. An estimate for lateral
 6 return flow was also made and is detailed in the next paragraph.

7
 8 **Table 7-9. Summary of irrigation water transfers on the Yellowstone River during 2007.**

Irrigation Unit	Period	Irrigation Withdrawal (cms)	Main Canal Return Flow (cms)	Estimated Lateral Return Flow (cms)
Cartersville Irrigation District	Aug 07	5.975	1.987	1.052 ^{est}
	Sep 07	2.519	1.330	0.990 ^{est}
Baringer Pumping Project	Aug 07	0.635 ^{est}	0.000 ^{est}	0.070 ^{est}
	Sep 07	0.355 ^{est}	0.000 ^{est}	0.159 ^{est}
Private Irrigation (pumps from YR)	Aug 07	2.543 ^{est}	0.164 ^{est}	0.435 ^{est}
	Sep 07	1.421 ^{est}	0.311 ^{est}	0.468 ^{est}
T & Y Irrigation District (return flow)	Aug 07	N/A	1.407 ^{est}	N/A
	Sep 07		1.039 ^{est}	
Kinsey Irrigation Company	Aug 07	2.572	0.101	0.684 ^{est}
	Sep 07	2.650	0.797	0.678 ^{est}
Shirley Unit - Buffalo Rapids	Aug 07	3.228	0.454	0.401 ^{est}
	Sep 07	1.420	0.440	0.431 ^{est}
Terry Unit- Buffalo Rapids	Aug 07	1.584	0.000	0.255 ^{est}
	Sep 07	0.528	0.000	0.306 ^{est}
Fallon Unit – Buffalo Rapids	Aug 07	2.039	0.000	0.229 ^{est}
	Sep 07	1.359	0.027	0.283 ^{est}
Glendive Unit – Buffalo Rapids	Aug 07	9.232	n/a	1.548 ^{est}
	Sep 07	5.295		1.410 ^{est}

9 ^{est}=Values estimated using regression procedure; n/a – not applicable, location outside of project area.

10
 11 Lateral return flows in **Table 7-9** are entirely estimated. They comprise irrigation waste drain laterals
 12 which are small canals that branch off the main canal that could not be measured due to their diffuse
 13 nature. A study by Montana State University (MSU) was used to fill this deficiency (H. Sessoms, personal
 14 communication)¹ by relating irrigated area [as determined by landcover (e.g., pasture/hay and row
 15 crops) (Homer, et al., 2004)] with the return flow values provided by MSU. The regressions were quite
 16 good for August ($r^2=0.96$), and poor for September ($r^2=0.25$), which reflects the variability in return flow
 17 at the close of the irrigation season.

¹ The waste drain lateral return flow study was completed on Clear Creek, Sand Creek, and Whoopup Creek. These data were extrapolated to other areas in the project site. According to Schwarz (1999), the Buffalo Rapids Unit II has a conveyance efficiency of 89.3% while Unit I is only 73.7% efficient. Complete details regarding the irrigation estimates can be found in **Appendix B**.

7.2.2 Groundwater

The contribution of groundwater from **Equation 7-1** is the only unknown term (i.e., it could be either $Q_{in,j}$ or $Q_{ab,j}$ depending on conditions). Accretion was estimated according to **Equation 7-2**, where g_w is the groundwater contribution in [$m^3 s^{-1}$] and $Q_{gage,i}$, $Q_{gage,i-1}$, $Q_{in,i}$, and $Q_{ab,i}$ were defined previously. Given the short duration of the study, it was assumed that there was no change in storage (ΔS).

(Equation 7-2)
$$g_w = \Delta S + Q_{gage,i} - Q_{gage,i-1} + Q_{in,i} - Q_{ab,i}$$

Groundwater inflow comprised most of the influent (i.e., $Q_{in,j}$) water to the study reach (40-50%) but was still only a small percentage (10-15%) of the total flow in the river ($Q_{gage,i}$, $Q_{gage,i-1}$). Most of the exchange likely comes from the shallow hydrologic unit which is less than 200 feet below the land surface (Smith, et al., 2000). The primary mechanism of recharge is believed to be leaky irrigation ditches or regional groundwater flow systems (Moulter, et al., 1953; Moulter and Kohout, 1958; Torrey and Kohout, 1956; Torrey and Swenson, 1951), which seems to fit with the spatial orientation of our field observations.

7.2.3 Evaporation

Evaporation is not computed in Q2K but DEQ made estimates to determine its significance. Published pan data from the Huntley Experimental Station (244345) and Sidney Airport (247560) were used. Pan coefficients from Farnsworth, et al., (1982)¹ were used to correct the data to free water surface (FWS) evaporation which yielded daily rates of 4 and 3 mm day⁻¹ (0.16, 0.12 inches day⁻¹) for August and September respectively. Such estimates compare well with Pochop, et al., (1985) and indicate approximately 1.710 m³ s⁻¹ (60.4 ft³ s⁻¹) and 1.318 m³ s⁻¹ (46.5 ft³ s⁻¹) of evaporation occur during each period in the river (which were applied as a diffuse abstraction in the model)².

7.2.4 Water Balance During Summer 2007

The water balance as determined from prior information is shown in **Figure 7-3, Table 7-10, and Table 7-11** for 2007. Its most important consideration was flow at the upstream boundary (Forsyth) which comprised nearly 70% of the inflow to the study reach. Of the other inflows (normalized to each other), groundwater was the biggest contributor at 41% and 52%, followed by the Tongue River (17% and 16%), unmeasured waste drains (16% and 13%), and the Powder River (8% and 6%).

¹ A pan coefficient of 0.72 was used which compares reasonably with most work in the United States (Linsley, et al., 1982). It does not compare that well with reported values for Fort Peck Reservoir (0.64 and 1.21 each month) (Army Corps of Engineers, 2003). Given the inability of DEQ to verify the source of the Corps data [i.e., their cited values could not be found in Farnsworth and Thompson (1982)] where it supposedly should have been found, DEQ used the standard NOAA methodology instead.

² It should be noted that the way in which we have applied evaporation in the model is a slightly simplification. We have implemented it as a mass removal, which also removes constituent mass. The model is being modified to make such changes (personal communication, S. Chapra).

1
2
3
4
5
6
7
8

Irrigation and domestic water withdrawals were significant and amounted to 30 and 15% of the overall flow in the river (in August and September, respectively). Consequently a large portion of water in the river is removed for the purpose of irrigation. The largest diversions were the Buffalo Rapids Irrigation District which removed over $14 \text{ m}^3 \text{ s}^{-1}$ ($\sim 500 \text{ ft}^3 \text{ s}^{-1}$) (including the Shirley, Terry, and Glendive units) followed by the Cartersville Irrigation District which removed nearly $6 \text{ m}^3 \text{ s}^{-1}$ ($\sim 200 \text{ ft}^3 \text{ s}^{-1}$). Some of this water makes its way back to the river as return flow.

9

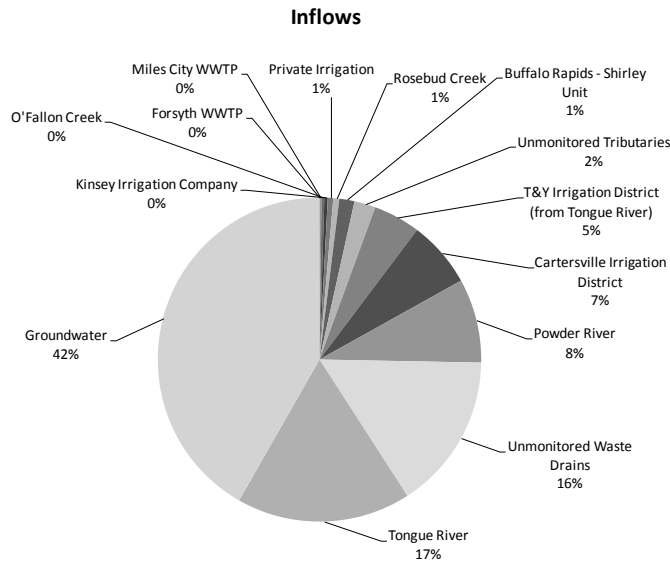

10
11
12
13
14
15
16
17

Outflows

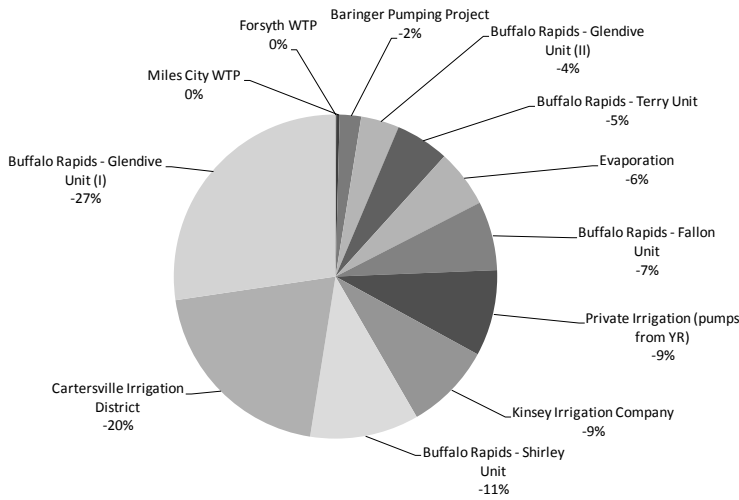

Figure 7-3. Graphical summary of water exchanges in the Yellowstone River during August 2007. (Top panel) Summary of inflows to the river during August of 2007. Note that the values shown are relative to one another; river flow at the upstream boundary (at Forsyth) accounted for 70% of the total inflow (thus these represent fractions of the remaining 30%). (Bottom panel). Summary of outflows (i.e., diversions) during August of 2007. Withdrawals shown as negative to reinforce the fact that water is being removed from the river.

1 **Table 7-10. Tabular summary of Yellowstone River water balance for August 2007.**

Unit	Site Name	Flow (m ³ s ⁻¹)	Balance	Ground water (m ³ s ⁻¹)	Comment
1	USGS (06295000) Yellowstone at Forsyth	99.849	99.849	+7.259	Avg. 8/17-26
	Forsyth WTP ¹	-0.022	99.827		8/17
	Cartersville Irrigation District DVT	-5.975	93.852		Avg. 8/17-26
	Forsyth WWTP ²	+0.011	93.864		Avg. 8/17-26
	Rosebud Creek	+0.180	94.044		8/18
	Cartersville Irrigation District RTN	+1.987	96.031		8/20
	Baringer Pumping Project DVT	-0.635	95.396		Avg. 8/17-26
	Baringer Pumping Project RTN	+0.000	95.396		Avg. 8/17-26
	Private Irrigation (pumps from YR)	-2.543	92.853		Avg. 8/17-26
	Private Irrigation (pumps from YR)	+0.164	93.017		Avg. 8/17-26
	Miles City WTP ¹	-0.102	92.915		Avg. 8/17-26
	Tongue River	+5.227	98.142		Avg. 8/17-26
	Unmonitored Tributaries	+0.173	98.316		Avg. 8/17-26
	Unmonitored Waste Drains	+1.558	99.873		Avg. 8/17-26
	Evaporation	-0.601	99.273		Avg. 8/17-26
USGS (06309000) Yellowstone at Miles City	106.532	99.273	Avg. 8/17-26		
2	Miles City WWTP ²	0.052	106.584	+4.627	Avg. 8/17-26
	Kinsey Irrigation Company DVT	-2.572	104.012		8/18
	T&Y Irrigation District RTN (from Tongue R.)	1.407	105.419		Avg. 8/17-26
	Buffalo Rapids - Shirley Unit DVT ²	-3.228	102.191		Avg. 8/17-26
	Kinsey Irrigation Company RTN	0.101	102.292		8/18
	Buffalo Rapids - Shirley Unit RTN ²	0.454	102.746		8/23
	Powder River	2.519	105.266		Avg. 8/17-26
	Buffalo Rapids - Terry Unit DVT ²	-1.584	103.682		Avg. 8/17-26
	Terry WWTP	0.000	103.682		Avg. 8/17-26
	Unmonitored Tributaries	0.227	103.909		Avg. 8/17-26
	Unmonitored Waste Drains	1.340	105.249		Avg. 8/17-26
	Evaporation	-0.569	104.680		Avg. 8/17-26
	USGS (06326530) Yellowstone near Terry	109.307	104.680		Avg. 8/17-26
3	Buffalo Rapids - Terry Unit RTN	0.000	109.31	+0.647	Avg. 8/17-26
	O'Fallon Creek	0.082	109.39		8/26
	Buffalo Rapids - Fallon Unit DVT ²	-2.039	107.35		Avg. 8/17-26
	Buffalo Rapids - Fallon Unit RTN	0.000	107.35		Avg. 8/17-26
	Buffalo Rapids - Glendive Unit (I) DVT ²	-8.099	99.25		Avg. 8/17-26
	Buffalo Rapids - Glendive Unit (II) DVT ²	-1.133	98.12		Avg. 8/17-26
	Unmonitored Tributaries	0.242	98.36		Avg. 8/17-26
	Unmonitored Waste Drains	1.778	100.14		Avg. 8/17-26
	Evaporation	-0.541	99.60		Avg. 8/17-26
	USGS (06327500) Yellowstone at Glendive	100.245	99.60		Avg. 8/17-26

2 ¹From monthly reports of finished clearwell effluent.3 ²Provided directly by city or irrigation district.

4

1 **Table 7-11. Tabular summary of Yellowstone River water balance for September 2007.**

Unit	Site Name	Flow (m ³ s ⁻¹)	Balance	Ground water (m ³ s ⁻¹)	Comment
1	USGS (06295000) Yellowstone at Forsyth	114.744	114.744	+3.459	Avg. 9/11-20
	Forsyth WTP ¹	-0.017	114.727		8/17
	Cartersville Irrigation District DVT	-2.519	112.208		Avg. 9/11-20
	Forsyth WWTP ²	+0.011	112.219		Avg. 9/11-20
	Rosebud Creek	+0.122	112.341		9/12
	Cartersville Irrigation District RTN	+1.330	113.671		9/15
	Baringer Pumping Project DVT	-0.355	113.316		Avg. 9/11-20
	Baringer Pumping Project RTN	+0.000	113.316		Avg. 9/11-20
	Private Irrigation (pumps from YR)	-1.421	111.895		Avg. 9/11-20
	Private Irrigation (pumps from YR)	+0.311	112.206		Avg. 9/11-20
	Miles City WTP ¹	-0.089	112.117		Avg. 9/11-20
	Tongue River	+6.043	118.160		Avg. 9/11-20
	Unmonitored Tributaries	+0.212	118.372		Avg. 9/11-20
	Unmonitored Waste Drains	+1.617	119.989		Avg. 9/11-20
	Evaporation	-0.463	119.526		Avg. 9/11-20
USGS (06309000) Yellowstone at Miles City	122.985	119.526	Avg. 9/11-20		
2	Miles City WWTP ²	+0.048	123.033	+2.983	Avg. 9/11-20
	Kinsey Irrigation Company DVT	-2.650	120.383		9/11
	T&Y Irrigation District RTN (from Tongue R.)	+1.039	121.423		Avg. 9/11-20
	Buffalo Rapids - Shirley Unit DVT ²	-1.420	120.002		Avg. 9/11-20
	Kinsey Irrigation Company RTN	+0.797	120.799		9/11
	Buffalo Rapids - Shirley Unit RTN ²	+0.440	121.240		9/16
	Powder River	+2.206	123.445		Avg. 9/11-20
	Buffalo Rapids - Terry Unit DVT ²	-0.528	122.917		Avg. 9/11-20
	Terry WWTP	+0.004	122.921		Avg. 9/11-20
	Unmonitored Tributaries	+0.268	123.190		Avg. 9/11-20
	Unmonitored Waste Drains	+1.415	124.605		Avg. 9/11-20
	Evaporation	-0.440	124.165		Avg. 9/11-20
	USGS (06326530) Yellowstone near Terry	127.147	124.165		Avg. 9/11-20
3	Buffalo Rapids - Terry Unit RTN	0.000	127.147	+12.629	Avg. 9/11-20
	O'Fallon Creek	0.166	127.314		9/11
	Buffalo Rapids - Fallon Unit DVT ²	-1.359	125.954		Avg. 9/11-20
	Buffalo Rapids - Fallon Unit RTN	0.027	125.981		Avg. 9/11-20
	Buffalo Rapids - Glendive Unit (I) DVT ²	-5.295	120.686		Avg. 9/11-20
	Buffalo Rapids - Glendive Unit (II) DVT ²	0.000	120.686		Avg. 9/11-20
	Unmonitored Tributaries	0.285	120.971		Avg. 9/11-20
	Unmonitored Waste Drains	1.693	122.664		Avg. 9/11-20
	Evaporation	-0.415	122.249		Avg. 9/11-20
	USGS (06327500) Yellowstone at Glendive	134.878	122.249		Avg. 9/11-20

2 ¹From monthly reports of finished clearwell effluent.3 ²Provided directly by city or irrigation district.

4

7.3 Hydraulics and Mass Transport

After the flow balance was finalized, mass transport (i.e. advection) properties were determined. These can be calculated in one of three ways in the model: weirs, rating curves, or Manning's equation. For sharp-crested weirs, flow is related to head by **Equation 7-3** where B_w = width of the weir [m] and H_h = height of the water flowing over the weir [m]. The equation is then rearranged to solve for the depth upstream of the weir (for the purpose of advection and gas transfer computations). This method was used for the Cartersville Diversion Dam near Forsyth, MT.

(Equation 7-3)
$$Q_i = 1.83B_w H_h^{3/2}$$

At other locations, rating curves were employed. In the rating curve approach, the empirical coefficients a and b , and exponents α and β are used to relate depth (H [m]) and velocity (U [m]) to streamflow (Q [$\text{m}^3 \text{s}^{-1}$]) through the power relationships shown in **Equation 7-4** and **Equation 7-5** (Leopold and Maddock, 1953). The continuity equation then used to compute the remaining hydraulic properties including cross-sectional area, top width, surface area, volume, and hydraulic residence time.

(Equation 7-4)
$$U = aQ^b$$

(Equation 7-5)
$$H = \alpha Q^\beta$$

Also represented in the rating curves were natural grade controls (i.e., rapids). These had been identified previously by others (AGDTM, 2004) and include Menagerie Rapids, Buffalo Shoals, Bear Rapids, and Wolf Rapids. All are between Miles City and Glendive and result from entrenchment in erosion resistant sandstones and shales of the Fort Union Formation. Their location and associated features are shown in **Table 7-12**. They were incorporated into the model through adjustment of rating curve properties.

Table 7-12. Locations of natural grade controls on the Yellowstone River.

Name	Q2K Station (km)	Approximate Location	Estimated Depth (m)	Estimated Velocity (m s^{-1})
Menagerie Rapids	128.9	12 miles DS of Tongue River	0.56	0.88
Buffalo Shoals	122.9	Kinsey	0.63	0.75
Bear Rapids	95.4	20 miles DS of Buffalo Shoals	0.79	0.79
Wolf Rapids	82.9	3 miles DS of Powder River	0.56	0.77

In determining the rating curve relationships, a number of methods have been proposed to characterize them in Q2K. This includes physical field measurement of widths, depths, and velocities (Droic and Koncan, 1996; Park and Lee, 2002; Van Orden and Uchrin, 1993), output from water surface profile models (Dussailant, et al., 1997; Tischler, et al., 1985), and residence time/dye tracer fluorescence studies (Kuhn, 1991). A combination of methods were used in the Yellowstone River work. Subsequent lines of evidence included:

- Field observations of hydraulic properties at specified transects during 2007, (detailed in **Section 7.3.1**).
- Compilation of USGS rating measurements to evaluate depth- and velocity-discharge curves, (detailed in **Section 7.3.2**).
- GIS analyses of historical low-flow aerial photographs to assess channel hydraulic conditions, (detailed in **Section 7.3.3**).
- Dye tracer and associated travel time studies, (detailed in **Section 7.3.4**).

7.3.1 Field Observations of Hydraulic Properties

Width, depth, and cross-sectional area were measured at 23 transect locations between DEQ and USGS to provide ground-truth data for model mass transport. Measurements were made using a sounding weight, fiberglass tape, and laser range finders, or were directly surveyed using a total-station and fiberglass rod. In some instance, measurements were made at bridges. A channel approach angle correction was necessary to account for bridge skew.

Measurements are shown in **Table 7-13**. Cross-sectional plots for each of these sections are in **Appendix B** and are also discussed in **Section 10.0** regarding the application of AT2K.

Table 7-13. Hydraulic property transects within the lower Yellowstone River study reach.

Monitoring Site	Width (m)	Depth (m)	Area (m ²)
Yellowstone River at Forsyth Bridge ¹	124	2.58	321
Yellowstone River at Old Forsyth Bridge ¹	81	3.70	300
Yellowstone River at Rosebud West FAS (e.g. nr Forsyth) ¹	102	3.4	348
Yellowstone River at Far West FAS (nr Rosebud)	117	0.9	104
Yellowstone River at Rosebud Bridge	145	1.98	286
Yellowstone River at Paragon Bridge	312	0.91	312
Yellowstone River at Ft. Keogh Bridge (1902 Bridge)	179	1.59	285
Yellowstone River below 1902 Bridge US of Tongue River	132	1.5	194
Yellowstone River at Highway 59 Bridge (at Miles City)	171	1.06	182
Yellowstone River at Pirogue Island (nr Miles City)	134	0.9	119
Yellowstone River at Kinsey Bridge	187	0.93	174
Yellowstone River at Kinsey FAS	198	0.7	132
Yellowstone River US of Powder River	112	2.1	236
Yellowstone River US of Calypso Bridge	120	1.1	136
Yellowstone River at Calypso Bridge	130	1.58	206
Yellowstone River at Terry Highway Bridge	129	1.48	191
Yellowstone River US of O'Fallon Creek	174	1.4	235
Yellowstone River at Fallon Interstate Bridge	183	1.21	222
Yellowstone River at Fallon Frontage Bridge	183	1.20	220
Yellowstone River near Fallon Bridge	196	1.1	220
Yellowstone River at Glendive RR Bridge	339	2.88	977
Yellowstone River above Bell St. Bridge (e.g. Glendive)	133	1.6	210
Yellowstone River at Bell St. Bridge (e.g. Glendive)	141	1.84	141

¹ In backwater of Cartersville diversion dam.

1 In addition to the previous measurements, one low-head diversion dam (i.e., the Cartersville diversion
 2 dam near Forsyth) was also surveyed. This was done to estimate weir properties and storage upstream
 3 of the weir. The structure consisted of riprap capped concrete (U.S. Fish and Wildlife Service, 2008) and
 4 based on measurements on the south (right) it was 1.6 meters (5.3 feet) high and 236 meters wide
 5 (using an automatic level and laser range finder). Depth of water flowing over the weir was 0.3 meters
 6 (0.95 feet) at the time. The Cartersville Irrigation District was contacted to verify these field
 7 measurements, however, no information existed (P. Ash, personal communication).

8
 9 More recently however DOW-HKM Engineering has conducted fish passage studies of the structure.
 10 Based on field topographic surveys and 2-D modeling, they believe the dam to be 2.1 meters (7 ft) high
 11 with a crest elevation of 2507 feet above mean sea level (amsl) and a base of 2500 feet amsl (G. Elwell,
 12 personal communication). These values were used in the modeling. HKM drawings of the dam are
 13 shown in **Appendix B** and oxygenation coefficients for water quality and dam-type were selected by
 14 DEQ to be 1.6 and 0.75 which are representative of slightly polluted waters and a round broad-crest
 15 weir.

17 7.3.2 USGS Rating Measurements

18
 19 USGS field measurements¹ were compiled from NWIS to provide data to estimate the coefficient and
 20 exponent of **Equation 7-4** and **Equation 7-5**. These were subsequently regressed against discharge for all
 21 gages in the project site (**Table 7-14**)². The regression results are shown in **Figure 7-4**.

22
 23 **Table 7-14. USGS gage sites having rating measurement data on the Lower Yellowstone River.**

Description	Station ID	Observations (n=)	Period
Yellowstone River at Billings MT	06214500	320	1968
Yellowstone River at Forsyth MT	06295000	229	1953
Yellowstone River at Miles City MT	06309000	268	1974
Yellowstone River at Glendive MT	06327500	40	2002
Yellowstone River at Sidney MT	06329500	331	1967

24
 25 A best-fit curve was determined by the least squares method in Excel™ and an envelope of possible
 26 outcomes (i.e. upper and lower bounds) was included to represent uncertainty in the observations. Due
 27 to the relative uniformity and similarity of the river, a single exponent was deemed sufficient for the
 28 Q2K model which required the coefficient be adjusted to match observed depths, velocities, and time of
 29 travel in the model (e.g., through calibration). Overall, an exponent of 0.45 for depth and 0.41 for
 30 velocity were determined, with coefficients ranging from 0.1-0.2 and 0.05-0.15. Values are reasonable
 31 according to other studies (Barnwell, et al., 1989; Flynn and Suplee, 2010; Leopold and Maddock, 1953)
 32 and are shown in (**Table 7-15**).

¹ These are determined in the field as part of the process of rating a gage site and provide information on mean velocity and hydraulic depth at a particular location in the river.

² Hydraulic depth was assumed to be the cross-sectional area divided by channel top width.

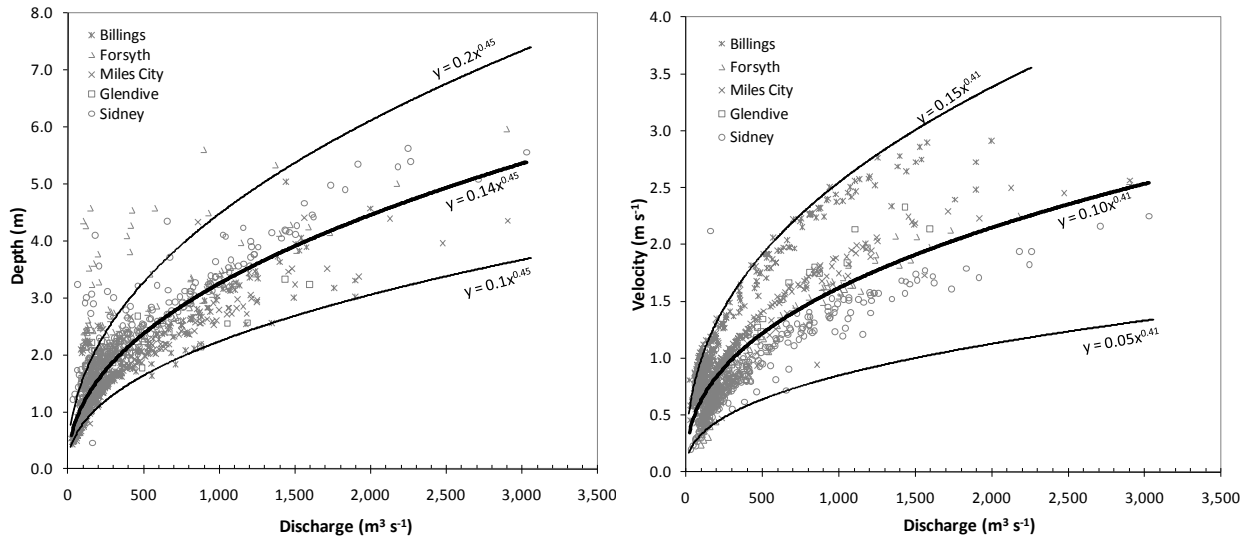

Figure 7-4. Depth and velocity rating curves derived for the lower Yellowstone River.

(Left panel). Depth vs. discharge. (Right panel) Velocity vs. discharge.

A final caveat about this effort is that in some instances the mean depth or velocity of a specific river segment will inevitably differ from what is determined through the use of the rating curve. This is a function of the idealized mathematical descriptions of channel hydraulic geometry, natural site variability, or un-described river mechanics. Thus the rating measurements are really estimates. Truth be told, the measurements themselves are variable according to field conditions and therefore represent the general behavior of the river rather than a unique site.

Table 7-15. Rating curve exponents derived for the Lower Yellowstone River.

Equation Form	Exponent	Typical Value ¹	Range ¹	Yellowstone River
Velocity $U = aQ^b$	b	0.43	0.4-0.6	0.41
Depth $H = \alpha Q^\beta$	β	0.45	0.3-0.5	0.45

¹From Barnwell and Brown (Barnwell, et al., 1989).

7.3.3 Dye Tracer Time of Travel Study

Time of travel estimates were made by USGS in 2008 as part of a cooperative study with DEQ (McCarthy, 2009) to support the modeling. Seven unique reaches were considered through slug injections of dye and subsequent observation of the dye centroid as it passed through the points along the river. Those locations evaluated included: (1) Forsyth Bridge to the Cartersville Diversion Dam, (2) Cartersville Diversion Dam to Rosebud Bridge, (3) Rosebud Bridge to Fort Keogh Bridge, (4) Fort Keogh Bridge to Kinsey Bridge, (5) Kinsey Bridge to Calypso Bridge, (6) Calypso Bridge to Fallon Bridge, and (7) Fallon Bridge to Glendive Bridge. Results are shown in **Table 7-16** and the overall travel time for the river was 73.4 hours (3.1 days) from Forsyth to Glendive [at flows of approximately 200 m³ s⁻¹ (7,000 ft³ s⁻¹)].

1 **Table 7-16. Travel-time data and mean streamflow velocities for the Yellowstone River in 2008.**
 2 Data from McCarthy (2009).

Site	Distance downstream from dye injection (mi)	Instantaneous streamflow (ft ³ /s)	Elapsed traveltime after dye injection (hours)		Mean streamflow transport velocity of dye cloud for upstream reach (ft/s)	
			Peak	Centroid	Peak	Centroid
Slug injection of dye (21 liters) at 1700 hours on September 29, 2008 at Myers Bridge						
Myers Bridge	0.0	6,750	0.00	0.00	--	--
Forsyth Bridge	44.5	6,890	22.3	22.9	2.93 ¹	2.85 ¹
Forsyth Dam	45.6	6,890 ²	23.1	23.8	2.10	1.83
Rosebud Bridge	59.1	6,890 ²	30.0	31.0	2.83	2.75
Slug injection of dye (33 liters) at 1000 hours on September 26, 2008 at Forsyth Dam						
Forsyth Dam	0.0	6,860 ²	0.0	0.00	--	--
Rosebud Bridge	13.5	6,860 ²	5.90	6.32	3.36 ¹	3.13 ¹
1902 Bridge	51.5	7,320 ²	25.5	26.2	2.85	2.80
Kinsey Bridge	65.8	7,350 ²	32.2	33.1	3.14	3.07
Slug injection of dye (51.5 liters) at 1003 hours on September 23, 2008 at Miles City Bridge						
Miles City Bridge	0.0	7,420	0.00	0.00	--	--
Kinsey Bridge	11.8	7,470 ²	4.98	5.11	3.48 ¹	3.39 ¹
Calypso Bridge	38.8	7,570	16.7	17.6	3.39	3.18
Fallon Bridge	56.8	7,380	25.2	26.3	3.08	3.02
Glendive Bridge	89.1	7,480	42.4	43.6	2.76	2.74

3 ¹Mean streamflow transport velocity of dye cloud affected by incomplete lateral mixing of dye.

4 ²Instantaneous streamflow estimated where discharge measurements could not be attained.

5
 6 Flow conditions during 2008 were unfortunately very different from those of 2007 (nearly double).
 7 Consequently, we relied on several methods to render the travel-times to 2007 conditions:

- 8
- 9 • Direct adjustment of the values calculated using McCarthy's (2006) Microsoft VBA travel-time
- 10 calculator from which relates flood wave velocity to most probable baseflow velocity (using
- 11 corrections obtained during 2008).
- 12 • Actual simulation of the 2008 flow condition and travel-time within Q2K.
- 13 • Adjustment of the dye study of 2008 (McCarthy, 2009) to 2007 conditions using interpretive
- 14 hydraulics.

15
 16 The latter is described in the next section. Results of all three methods are presented in **Section 10.0**.

17 **7.3.4 Interpretive Hydraulics**

18
 19 An interpretive hydraulic analysis was completed to relate the previous information in **Section 7.3** to the
 20 hydraulic reaches in **Section 7.1** (thereby providing a better model parameterization). Under conditions
 21 of steady flow, Manning's equation (**Equation 7-6**) can be used to express the relationship between
 22 velocity and depth by assuming a wide rectangular channel approximation where V = velocity [$m\ s^{-1}$], n
 23 = the Manning roughness coefficient, w = channel width [m], d = channel depth [m], S_f = bottom slope

1 [m m⁻¹] and where “*wd*” is also equal to the cross-sectional area [m²], and “*w+2d*” is the wetted
 2 perimeter [m].
 3

4 **(Equation 7-6)**
$$V = \frac{1}{n} \left(\frac{wd}{w + 2d} \right)^{2/3} S_f^{1/2}$$

5
 6 The equation can be rearranged and simplified as shown in **Equation 7-7**, with substitution from the
 7 continuity equation¹ thereby providing an equation with one unknown (depth) that can be solved
 8 iteratively provided the remaining variables are known.
 9

10 **(Equation 7-7)**
$$0 = \frac{wd}{Qn} \left(\frac{wd}{w + 2d} \right)^{2/3} S_f^{1/2} - 1$$

11
 12 We have identified the “knowns” of **Equation 7-7** as indicated in the bullets below. M.S. Excel™ was
 13 then used to write macros to solve for depth and complete the analysis for the river.
 14

- 15 • **Width** – Relationships between discharge and wetted width were used to estimate river width
 16 during 2007 according to GIS data identified in **Section 7.1**. Three different photo/data series
 17 were considered: (1) 2001 color infrared photos, (2) 2004/2007 aerial photography, and (3)
 18 digitized interpreted bankfull dimensions from Applied Geomorpholgy/DTM Consulting (2004)².
 19
- 20 • **Slope** – Channel gradient (e.g. friction slope) for each 100 m evaluation length was determined
 21 from the mosaiced 2.5 meter DEM of the lower Yellowstone River described in **Section 7.1**.
 22
- 23 • **Flow** – Flows based on the water balance output identified in **Section 7.2**
 24
- 25 • **Manning’s “n”** – Roughness values as estimated using calibrated roughness values from recent
 26 flood insurance studies (L. Hamilton, personal communication, n=0.028) with additional
 27 adjustment for the flow condition being evaluated (Chow, 1959). Recall Manning’s “n” varies
 28 with flow (**Figure 7-5**)³ and was believed to be around 0.050 in August and 0.049 in September.
 29

¹ Continuity equation is as follows, $Q = wdV$, where Q , w , d , and V are defined in the text.

² Simple and consistent relationships were established between flow and wetted channel width at the time of imaging [$\log(w)=0.15 \log(Q) + 1.867$]. This lead to very minor adjustments of the original widths determined from the 2001 color infrared photos (corrections of -2 and +3 meters).

³ Assuming no change in water surface slope over the range of flow conditions evaluated.

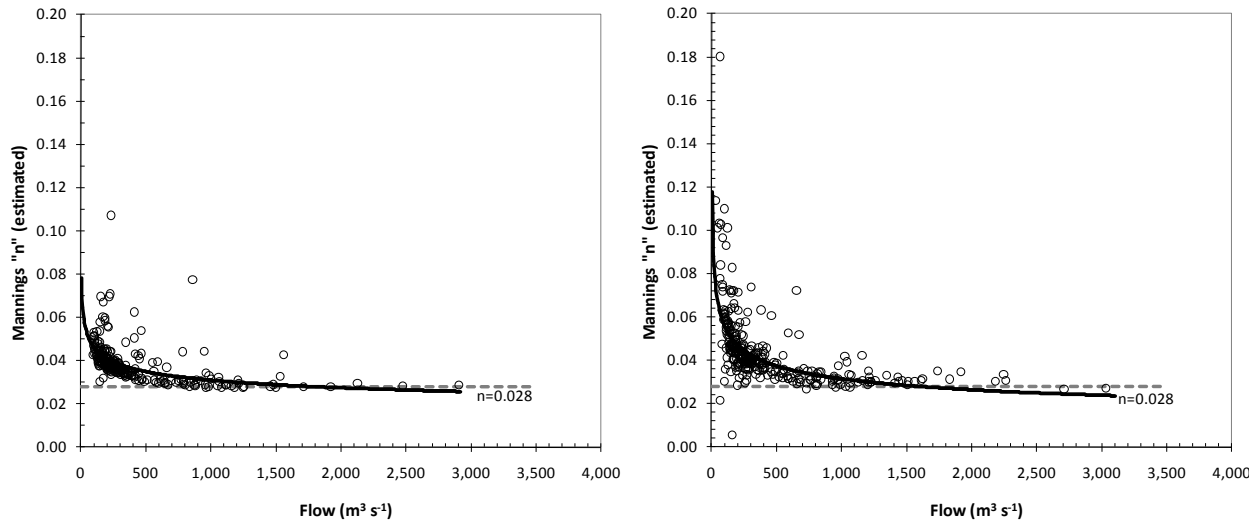

1
2 **Figure 7-5. Estimated variation of Manning's n with flow for the Yellowstone River.**

3 (Left panel) USGS 06309000 Yellowstone River at Miles City; (Right panel) 06329500 Yellowstone River near Sidney.

4
5 Results from this analysis are presented on the next page (**Figure 7-6**). Shown are: (1) the actual values
6 determined from the GIS analysis (width, depth, and velocity results every 100 meters along the
7 centerline of the channel), (2) values averaged over the hydraulic reaches identified in **Section 7.1** (note:
8 these are adjusted based on the 2008 to 2007 velocity correction), (3) velocities and depths determined
9 from the 2008 dye tracer study, (4) the 2008 to 2007 dye tracer study correction¹, and (5) actual field
10 data.

11
12 Computed wetted widths from this exercise ranged from approximately 175-350 m (575-1150 feet);
13 depths were 0.3-2.9 m (1.0-9.5 feet); and velocities were 0.3-1.0 m s⁻¹ (1.0-3.3 ft s⁻¹). All estimated
14 values reasonably reflect the observed 2007 field observations. Results were then used to translate
15 rating coefficients to the model for each unique hydraulic reach. These values are found in **Appendix C**
16 as part of the model input and range from 0.067-0.160 and 0.083-0.130 for the depth and velocity
17 coefficients respectively. Values are within the ranges established in the literature previously (**Section**
18 **7.3.2**) and yielded a travel time estimate of 4.1 days for August of 2007 (see **Section 10.2**).

¹ Adjusted dye velocities were determined from the rating curve in **Figure 7-4** where the difference in Q between 2007 and 2008 was used to determine ΔV . The adjustment was then applied to determine travel times during 2007 for which all hydraulic reaches were adjusted up or down so that the model matched the 2007 streamflow condition. This adjustment was made so that overall results of the Manning's equation representation (i.e., over the 100 meter lengths, and subsequent averages that comprise the hydraulic reach breaks) exactly matched the adjusted dye depths and velocities.

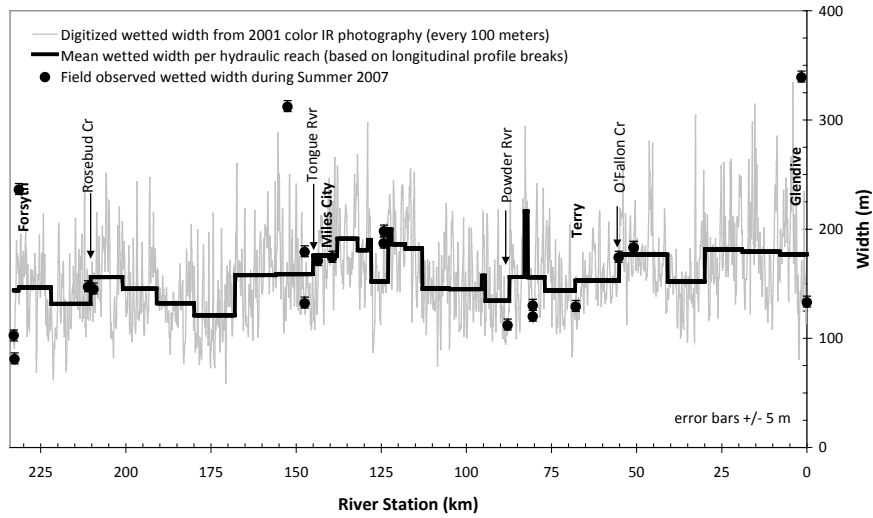

1

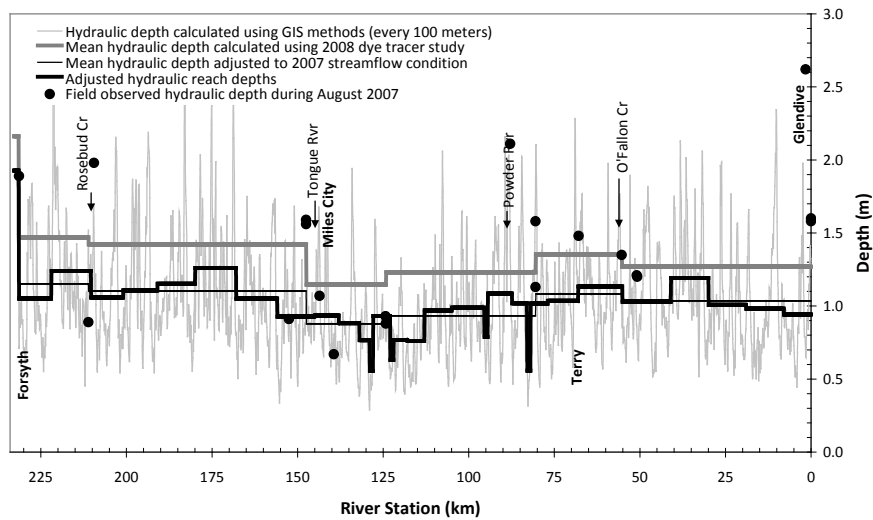

2

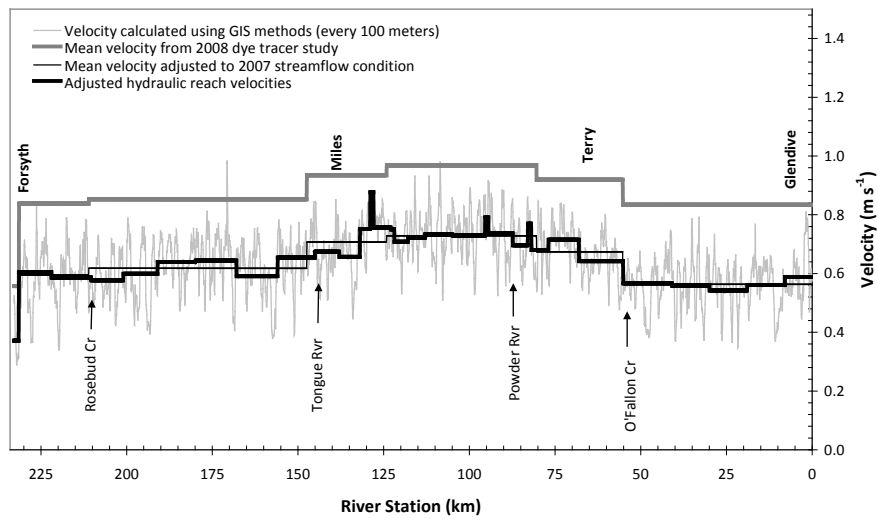

3

4 **Figure 7-6. Estimated width, depth, and velocity over 1 km increments in the Yellowstone River.**

5 Data shown for the August 2007 flow condition.

7.4 Atmospheric Model Input

7.4.1 Climatic Forcings

Required climatic input for Q2K includes air temperature [°C], dew point [°C], wind speed [m s^{-1}], solar radiation [cal cm^{-2}], and cloud cover [%]. Seven hourly climate stations were in operation in the lower Yellowstone River corridor during 2007. These included: (1) Forsyth W7PG-10 (AR184), (2) Sweeney Creek MT Department of Transportation (DOT) Road Weather Information System station (RWIS; MSWC), (3) National Weather Service (NWS) Miles City Municipal Airport (APT) station (COOP 245690), (4) DEQ Fort Keogh Agricultural Experiment station, (5) Bureau of Reclamation (BOR) Buffalo Rapids Terry AgriMet station (BRTM), (6) BOR Buffalo Rapids Glendive AgriMet (BRGM) station, and (7) NWS Glendive Community Airport (COOP 243581).

Information was retrieved via electronic download from the National Climatic Data Center (NCDC; www.ncdc.noaa.gov), MesoWest climate center (<http://www.met.utah.edu/mesowest>), and Bureau of Reclamation Great Plains AgriMet system (<http://www.usbr.gov/gp/agrimet>). Station attributes and climatic information for August and September 2007 are shown in **Table 7-17**.

Table 7-17. Hourly climatic stations and associated mean daily observations.

Data shown for the average of the August and September analysis periods.

Station	Station ID	Station Elevation (m)	Elevation above River (m)	Mean Air Temp. (°C)	Mean Dew point Temp. (°C)	Mean Wind Speed at 7m (m s^{-1})
Forsyth W7PG-10	AR184	887	120	Insufficient data		
Sweeney Cr (MDT)	MSWC	792	50	18.2	8.0	1.6
DEQ Ft. Keogh Ag. Exp.	DEQH	724	2	18.1	7.1	1.3
Miles City APT (NWS)	245690	803	90	18.2	5.5	3.9
AgriMET - Terry (Buffalo Rapids)	BRTM	692	30	16.8	6.1	2.9
AgriMet-Glendive (Buffalo Rapids)	BRGM	652	20	16.1	6.0	2.6
Glendive Community Airport (AWOS ¹ ; NWS)	726676	749	130	16.4	4.5	4.4

¹AWOS = Automated Weather Observation Station.

²Wind speed adjusted to 7 meter height using the wind power-law profile¹.

¹ Power wind law profile equation: $\frac{v}{v_7} = \left(\frac{z}{z_7}\right)^k \left(\frac{z}{z_7}\right)^k$ (Linsley, et al., 1982), where v and v_7 , and z and z_7 are velocity and measurement heights at their respective elevations above the ground (i.e., v_7 and z_7 at 7 meters). A $k=1/7$ has traditionally provided acceptable results over a wide range of meteorological conditions (Linsley, et al., 1982).

1 From the data in **Table 7-17**, it is apparent that stations close to the river in elevation have different
 2 climate conditions than those outside its influence. This is best illustrated through comparison of the
 3 Miles City Municipal Airport and DEQ's Yellowstone River site near Fort Keogh located on Roche Juan
 4 Island. The two sites were paired as part of the original project design (Suplee, et al., 2006b), and are
 5 located just 2.5 km (1.5 miles) apart. However, the airport is on an elevated bluff adjacent to the river
 6 while the DEQ site was on a slightly vegetated island near the water surface. Note the major differences
 7 in wind speed and dew point.

8
 9 Wind magnitudes were less nearer the river and more on the surrounding plateau which is explained by
 10 differences in surface roughness (i.e., trees) and river corridor entrenchment. Sheltering and turbulent
 11 eddies cause both the magnitude and directional shifts as observed when the primary wind direction
 12 was perpendicular to the river aspect (**Figure 7-7**). For dew point, values were much higher near the
 13 river and lower outside the river corridor which was expected due to the continuous source of
 14 evaporating water. Differences in both wind and dewpoint are consistent with Troxler and Thackston
 15 (1975) and Barthalow (1989) who suggest that river corridor effects cause considerable variability in
 16 climate.

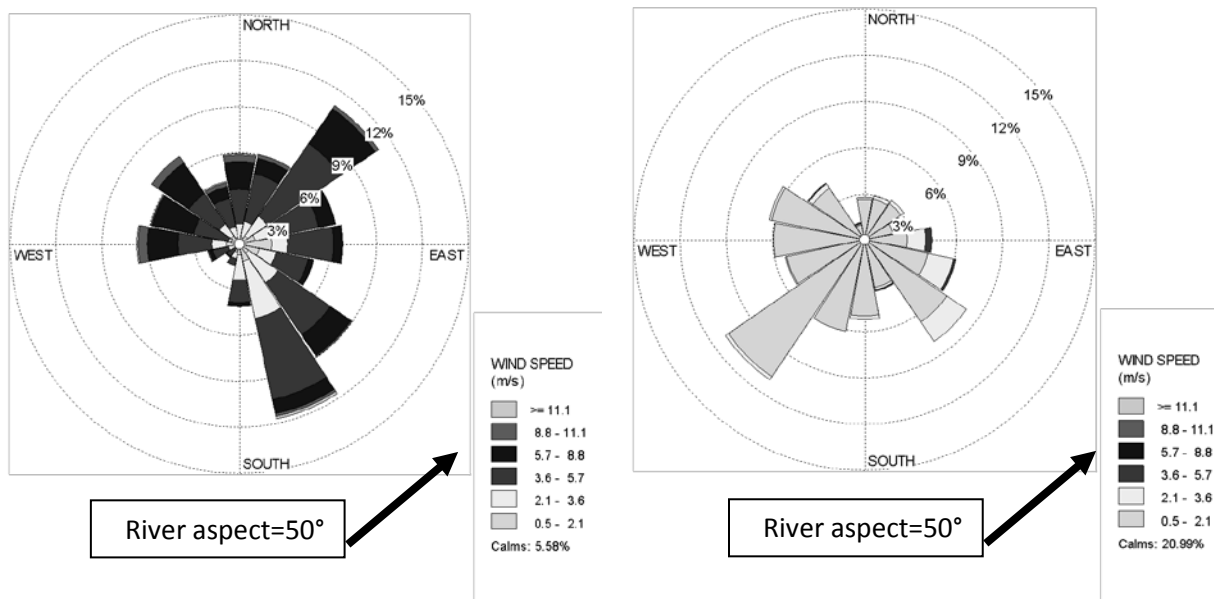

17
 18 **Figure 7-7. Paired wind rose data for the lower Yellowstone River during 2007.**

19 (Left panel) Wind magnitude and direction at the Miles City Municipal Airport. (Right panel) Same, but for the DEQ
 20 station on Roche Juan Island. The reversal in direction and decline in magnitude from turbulence was used in
 21 justifying wind speed correction factors for the model.

22
 23 Armed with this knowledge, only climatological sites in close proximity to the river were used for model
 24 development. Those satisfying our requirements were the following, and were assigned to spatially
 25 unique climatic zones in the model: (zone 1-Forsyth region) Sweeney Creek DOT station; (zone 2-Miles
 26 City region) Fort Keogh Agricultural Experiment Island station; (zone 3-Terry region) Buffalo Rapids Terry
 27 AgriMet station; and (zone 4-Glendive region) Buffalo Rapids Glendive AgriMet station. Time-series (air
 28 temperature, dewpoint, wind speed, and solar radiation) for these stations over the model development
 29 periods (i.e., calibration and validation) are shown in **Figure 7-8**. The shaded area reflects the maximum
 30 and minimum of the four climatic zones.

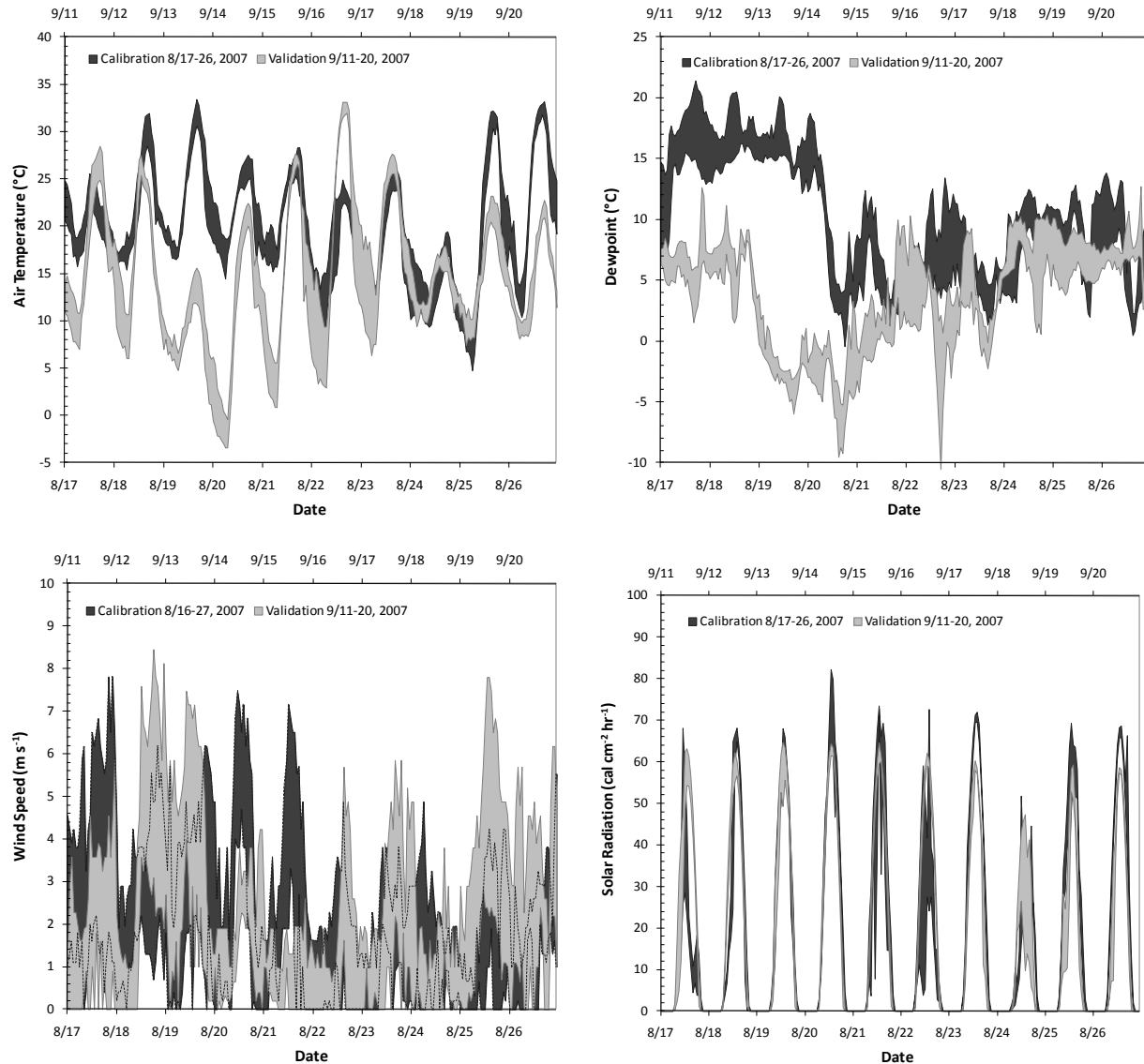

1

2

3 **Figure 7-8. Hourly meteorological data summary for lower Yellowstone River in 2007.**

4 (Top left/right panel) Air temperature and dew point for the four climatic zones of the lower Yellowstone River for
 5 the August 17-26 (calibration) and September 11-20, 2007 (validation) period. (Bottom left/right panel) Same but
 6 for wind speed and dew point. The shaded area represents the range of data observed in the four climatic zones.

7

8 From **Figure 7-8**, the biggest difference between the calibration and validation is air temperature and
 9 dew point (and to a lesser extent wind). This is primarily related to time of year, and the difference
 10 between summer and fall conditions. What is not apparent is that there is a spatial climatic gradient
 11 between sites. The upper portion of the river experiences warmer air temperatures, less wind, and
 12 higher humidity than the lower river in all instances. This can be seen in **Table 7-17** (shown previously).

13

14 Time series in **Figure 7-8** were aggregated into mean repeating day hourly distributions (**Figure 7-9**) to
 15 provide the required input for Q2K (recall that Q2K operates on the principle of a repeating day
 16 simulation where every day in the model run has the same hourly conditions). Subsequently,
 17 observations at 6:00 a.m., 7:00 a.m., and so on were averaged over the analysis period (10 days) so that

1 one day's weather pattern is repeated. In this instance, the daily distribution of data as well as the diel
 2 difference between the calibration and validation time period is clear to see. For example, August was
 3 warmer than September but during both periods air temperature is at a minimum at around 6:00 a.m.
 4 and peaks around 5:00 p.m. Dew point has an inverse relationship to temperature and again was much
 5 less in September. Winds were similar both periods and are calmest around daybreak and peak in the
 6 midday or early evening. Solar radiation and day length were slightly greater in August than September
 7 and sunrise and sunset each month with a solar radiation peak at solar noon (around 1:00 p.m.) and
 8 sunrise and sunset about 6:00 a.m. and 7:00 a.m. and 8:00 p.m. and 9:00 p.m., respectively.
 9

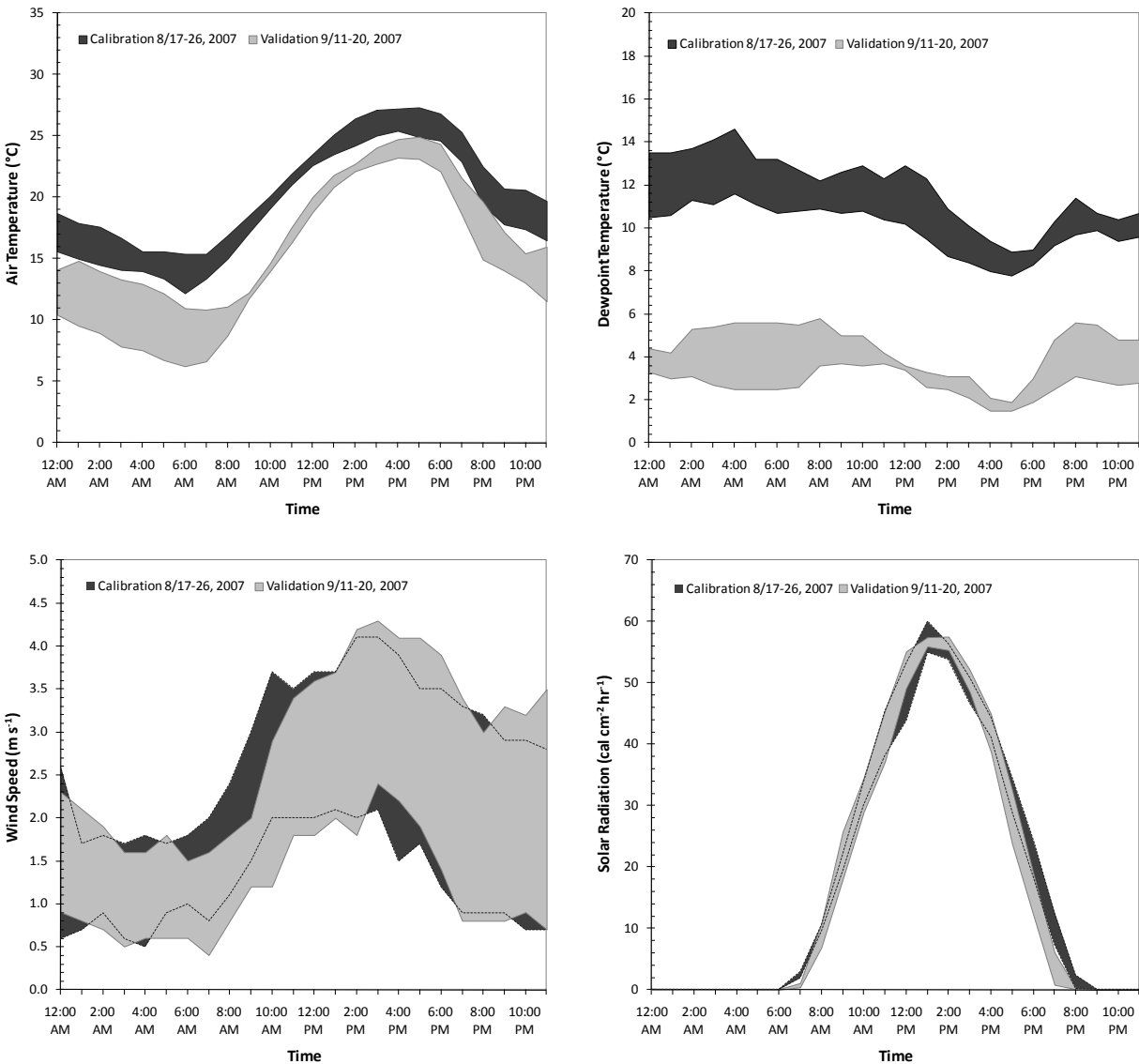

10

11
 12
 13
 14
 15
 16
 17
 18

Figure 7-9. Mean repeating day climate inputs for lower Yellowstone River Q2K model.
 (Top left/right panel) Air temperature and dew point for the four climatic zones for the August 17-26 (calibration)
 and September 11-20, 2007 (validation) period. (Bottom left/right panel) Same but for wind speed and dew point.
 Data reflects a mean repeating day and the shaded area represents the range of data for the climatic zones used in
 the model.

1 Of the information shown thus far, all were direct input variables to Q2K except solar radiation. Instead,
 2 solar radiation is modeled by prescribing cloud cover, solar constant, cloud scattering coefficients,
 3 atmospheric transmission, and topographic/vegetative shade. To establish these parameterization
 4 constraints, observed radiation was used in conjunction with other field measurements.

5
 6 Sky cover descriptions from the Miles City Municipal Airport and Glendive Airport and were translated
 7 to cloud cover percentages according to NOAA procedures (**Table 7-18, Figure 7-10**) and these estimates
 8 were used to evaluate of solar radiation simulations from the model. It was found that the Bras solar
 9 model with atmospheric turbidity coefficient of 2.8 provided the most realistic estimate of incoming
 10 solar radiation for the August calibration period (**Figure 7-11**). Because atmospheric conditions were
 11 clearer in September (i.e., it was hazier in August according to field observations) a turbidity coefficient
 12 of 2.0 was used for the validation.

13
 14 **Table 7-18. Cloud cover classes and associated conversions.**

Sky Cover Summation	Description	Translated Cloud Cover (%)
0: CLR	No coverage	0.00
1: FEW	2/8 or less coverage (not including zero)	0.13
2: SCATTERED	3/8 to 4/8 coverage	0.44
3: BROKEN	5/8 to 7/8 coverage	0.75
4: OVERCAST	8/8 coverage	1.00

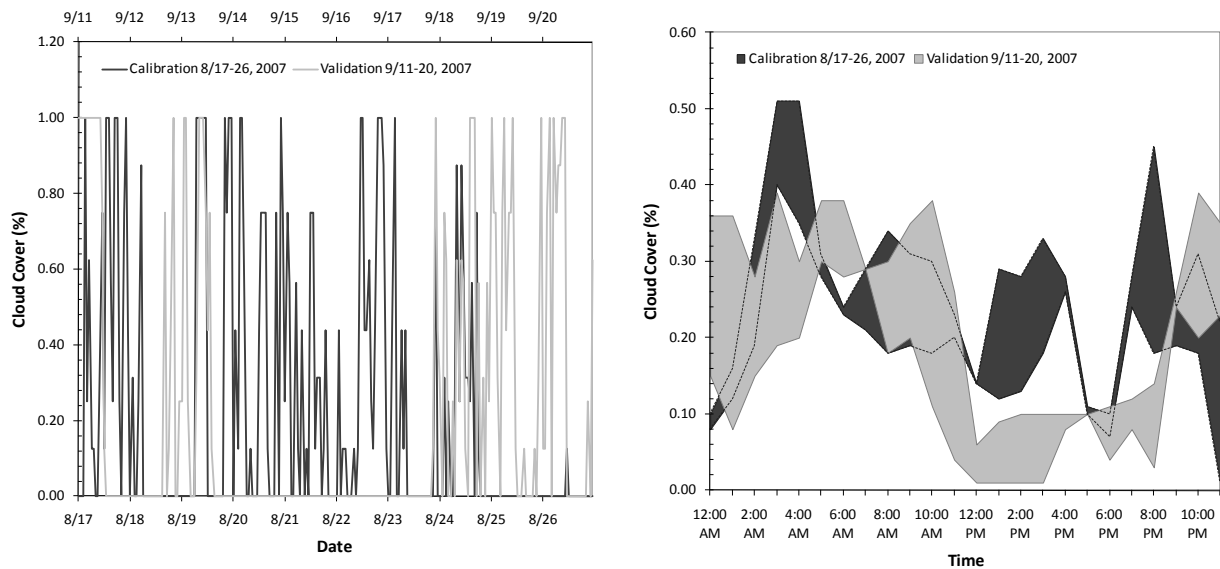

16
 17 **Figure 7-10. Hourly and repeating day cloud cover data for the lower Yellowstone River.**
 18 (Left panel) Cloud cover data for the 2007 period. (Right panel) Same but in a mean repeating day format. The
 19 range of the climatic stations used in the modeling is shaded.
 20

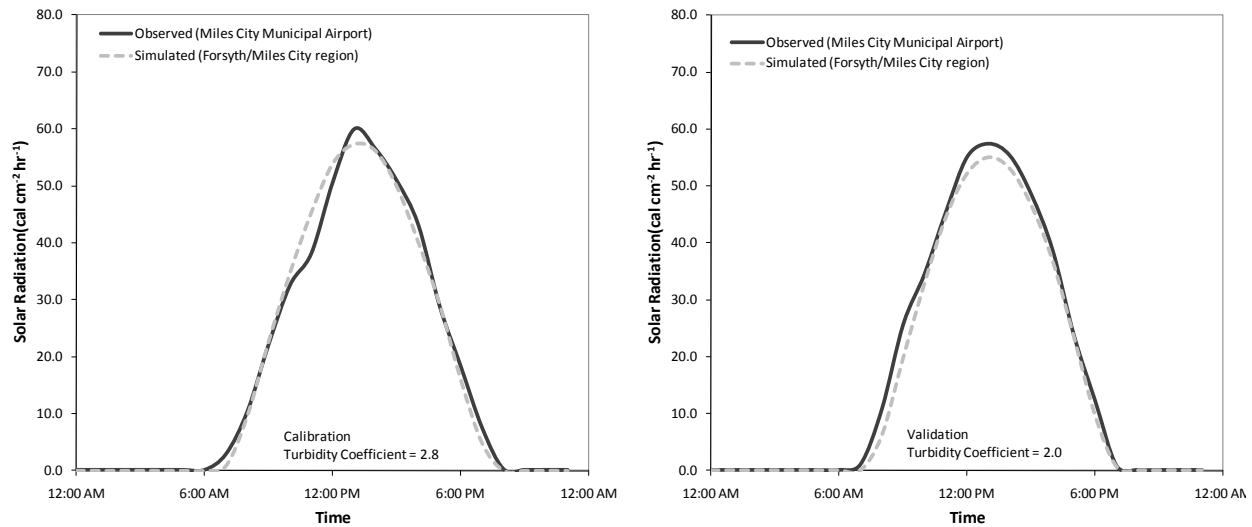

1
2 **Figure 7-11. Simulated and observed solar radiation for the lower Yellowstone River.**
3 (Left panel) Simulated and observed solar radiation for August 17-26, 2007 at Miles City Wiley Field. (Right panel)
4 Same but for September 11-20, 2007.

6 7.4.2 Carbon Dioxide and Aerial Deposition

7
8 Besides the climate data described previously, CO₂ concentrations and dry deposition rates of nutrients
9 are also needed for the model. Such information is not readily available near the project site and the
10 closest locations were the Dahlen, ND GLOBALVIEW-CO₂ monitoring site at the Fargo Jet Center (in
11 eastern ND) and an EPA CASTNET site at the Theodore Roosevelt National Park-Painted Canyon in ND
12 (THR422, NADP site ND00) (EPA, 2010b). Both locations are similar in climate and topography to the
13 lower Yellowstone River and therefore provide good approximations.

14
15 For the model, carbon dioxide concentrations determined every 8 days during 2007 (NOAA, 2010b) at
16 Dahlen were used. Observations that fell during August and September were 375 and 378 ppm. A
17 historical chart showing concentrations from that site are shown in **Figure 7-12** (left). Dry deposition was
18 estimated from the CASTNET site. Concentrations of nitric acid, ammonium, and particulate nitrate in
19 the weekly filter pack samples and deposition velocity from the Multi-Layer Model were used.
20 Accordingly, nitrogen dry deposition levels averaged 0.71 and 0.66 kg N ha⁻¹ yr⁻¹ in August and
21 September 2007 (**Table 7-19**) and have historically been consistent over time (**Figure 7-12**, right). Fluxes
22 were applied to the channel surface area (m² converted to ha for a total of 3,084 ha of total river surface
23 area) but were hardly worth considering as daily deposition was about 6 kg N per day (much less than
24 even a single small tributary flow into the river).
25
26

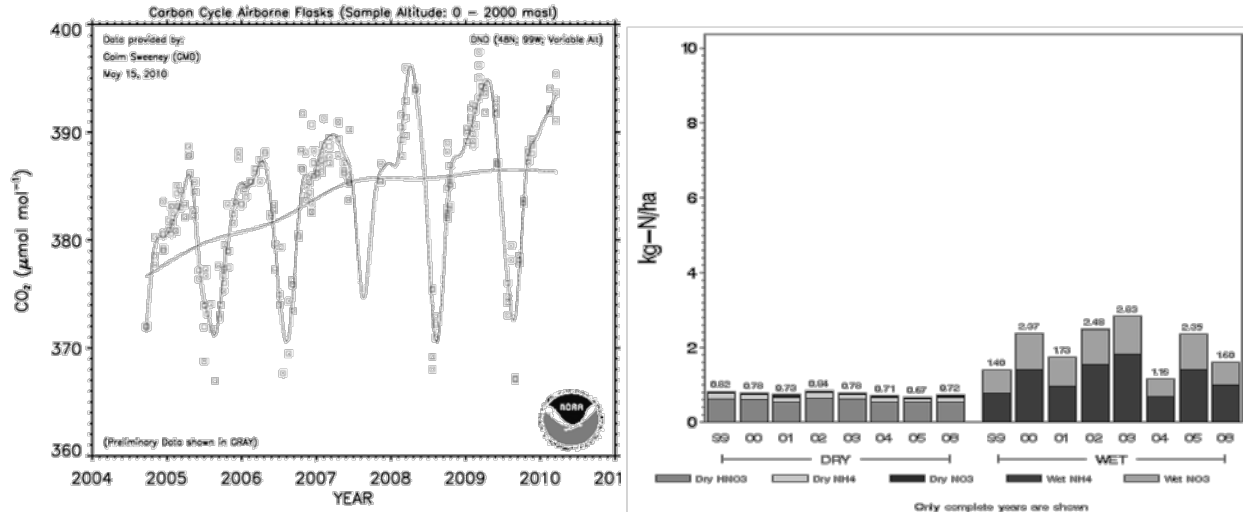

Figure 7-12. CO₂ data and nitrogen dry deposition by species for the Yellowstone River. (Left panel) CO₂ data from the Dahlen, ND GLOBALVIEW-CO₂ monitoring site (2004-2010). (Right panel) Nitrogen deposition data from Theodore Roosevelt, National Park EPA CASTNET site (1999-2008). Both figures taken directly from the data provider with permission.

Table 7-19. Dry deposition by nitrogen species estimated for lower Yellowstone River.

Data from Theodore Roosevelt National Park EPA CASTNET site for the August and September calibration and validation periods.

Species	Flux (kgN ha ⁻¹ yr ⁻¹)	Molar ratio (massN:mass)	Flux (kgN ha ⁻¹ yr ⁻¹)
Nitric Acid - HNO ₃	2.73 2.29	0.222	0.61 (August) 0.51 (September)
Total ammonium - NH ₄	0.09 0.16	0.777	0.07 (August) 0.12 (September)
Particulate nitrate - NO ₃	0.09 0.10	0.292	0.03 (August) 0.03 (September)
Total N	-----	-----	0.71 (August) 0.66 (September)

7.5 Shade Analysis

Shade is optional to Q2K and we did a simplified analysis to estimate its importance in the model. We applied a companion model Shadev3.0.xls which is a visual basic applications (VBA) software originally developed by the Oregon Department of Environmental Quality and modified by Washington Ecology to estimate shade as a function of aspect, channel width, vegetation canopy, bank elevations, near stream disturbance zone, and solar position (Pelletier, 2007). DEQ was unable to acquire all of the input for the model (e.g., vegetation characteristics and channel entrenchment) therefore we substituted data from other rivers in the state (tree height, density, etc.) to make our estimate. Vegetation information from the 2003 assessment of the river (NRCS, 2003) and the National Land Cover Dataset (Homer, et al., 2004) were used to identify species in **Table 7-20** and complete the associated parameterization. Using a riparian zone sampling distance of 25 meters, the Chen method (which includes both topography and

1 vegetation), and other assumptions in **Table 7-20**, daytime shade in August ranged from 0.3-13.3%, and
 2 averaged 2.5% over the project reach. Values for September were 0.3-15.8% and 2.9% respectively.
 3 Simulated shade is shown in **Figure 7-13**.

4

5 **Table 7-20. Riparian landcover types and associated attributes used to estimate shade.**

Vegetation Type ¹	Height (m)	Density (%)	Overhang (m)
Open Area or Primary Outwash	0.0	0%	0.0
Urban Areas	0.0	0%	0.0
Barren Land, Rock, Sand, Clay	0.0	0%	0.0
Deciduous Forest (sparse)	17.2	38%	0.1
Deciduous Forest (dense)	18.9	85%	0.3
Evergreen Forest	15.3	70%	0.0
Shrub, Scrub	1.0	50%	0.0
Grassland, Herbaceous	0.4	50%	0.0
Pasture, Hay	0.5	70%	0.0
Cultivated Crops	0.5	70%	0.0
Woody Wetlands (sparse)	4.9	40%	0.0
Woody Wetlands (dense)	5.7	75%	0.3
Emergent Herbaceous Wetlands	0.5	70%	0.0

6 ¹Data taken from Big Hole and Bitterroot Rivers. Channel incision was estimated to be 2.0 m throughout the
 7 project reach.
 8

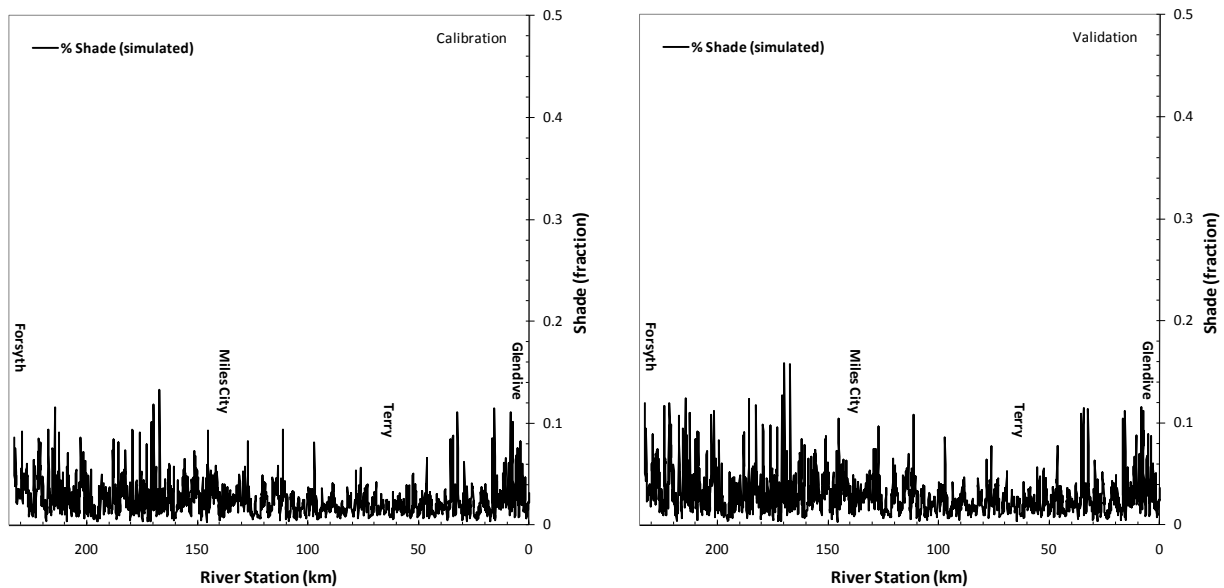

9

10

11 **Figure 7-13. Simulated mean daily shade for the Yellowstone River.**

12 (Left panel) Simulated shade for the August 17-26, 2007 period. (Right panel) Same but for September 11-20. No
 13 field data were available to verify the simulations. In both cases, shade is a minor component as indicated by mean
 14 daily shading of less than 20% throughout the river.

15

7.6 Boundary Condition Data

The final Q2K requirement is boundary condition data. This information was measured in the field to the extent possible and some aspects of the data have already been detailed [Section 6.4 (headwater boundary conditions) and Section 7.4 (air-water interface)]. The remaining uncharacterized components are external loadings from surface and groundwater.

7.6.1 Inflow Water Chemistry Data

A summary of the influent water chemistry to the Yellowstone River is shown graphically in Figure 7-14¹ by source (e.g., WWTPs, tributary inflows, irrigation canal return flows, etc.). The maximum and minimum values, associated percentiles, and observed values during 2007 are identified.

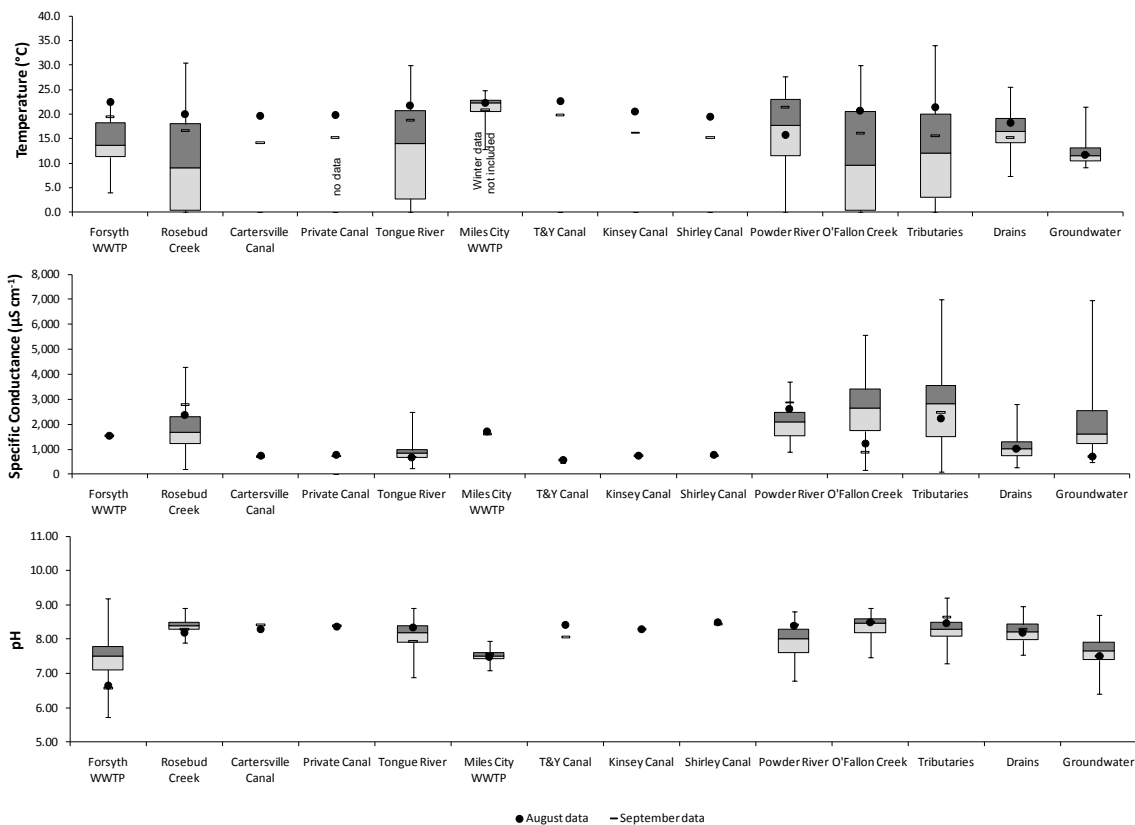
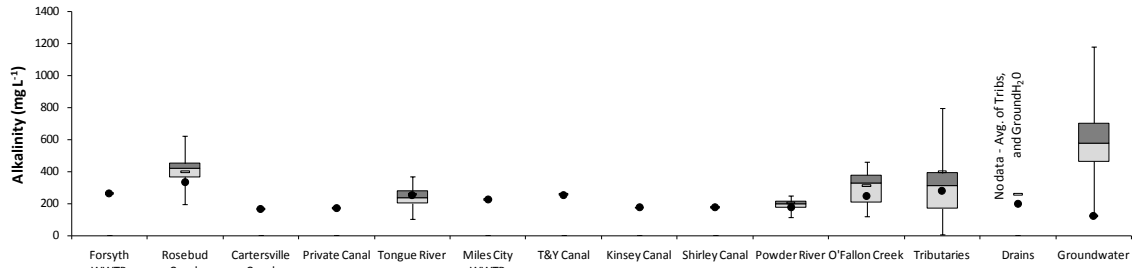

Figure 7-14. Comparative water quality inflow plots for the Yellowstone River.

¹ The database constructed in Section 6.2 was used to provide the information for Figure 7-14. In several instances, values were scaled down by a factor of 10 (e.g., WWTPs) or were cut off for plotting purposes. Refer to the comments in the figures in these instances.

1



2

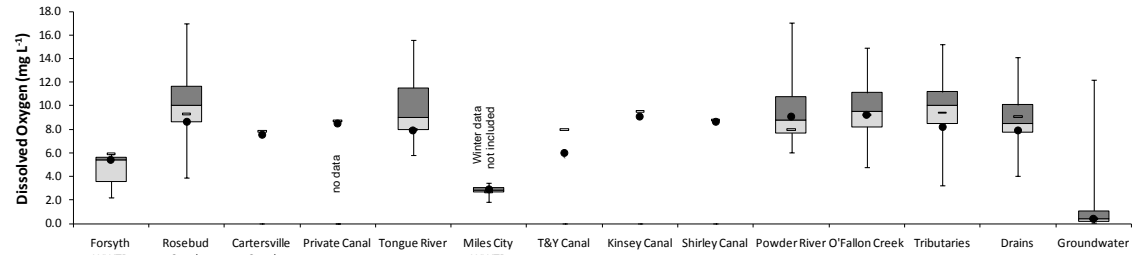

3

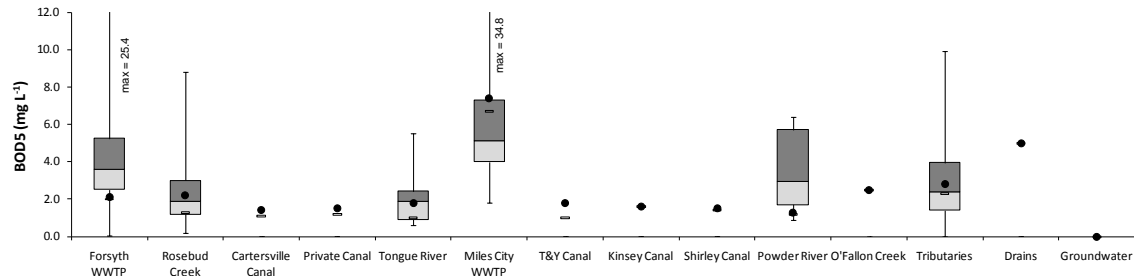

4

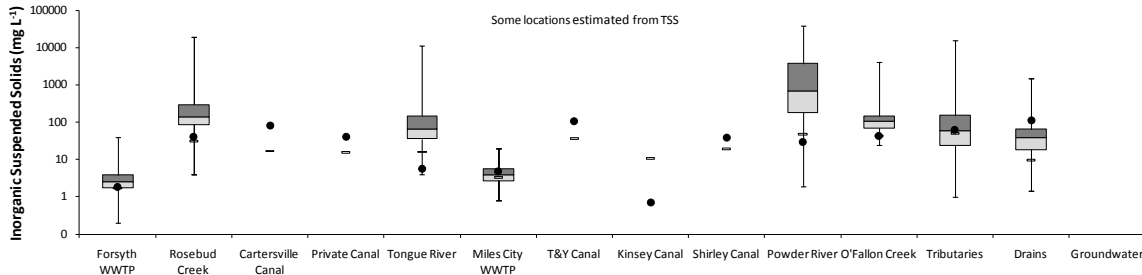

5

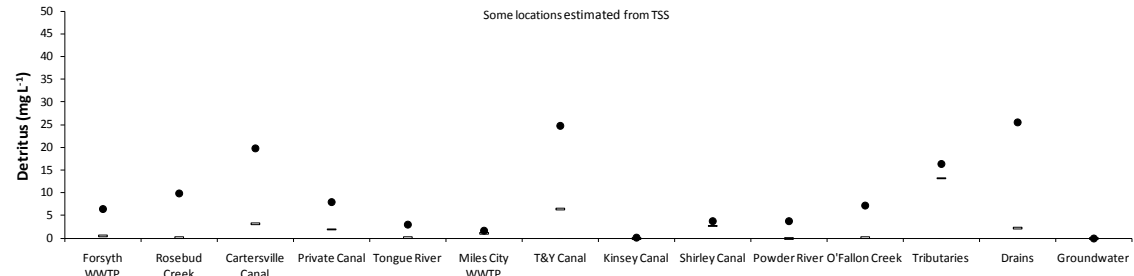

● Calibration data — Validation data

6

7

8

Figure 7-14 (continued). Comparative water quality inflow plots for the Yellowstone River.

9

1

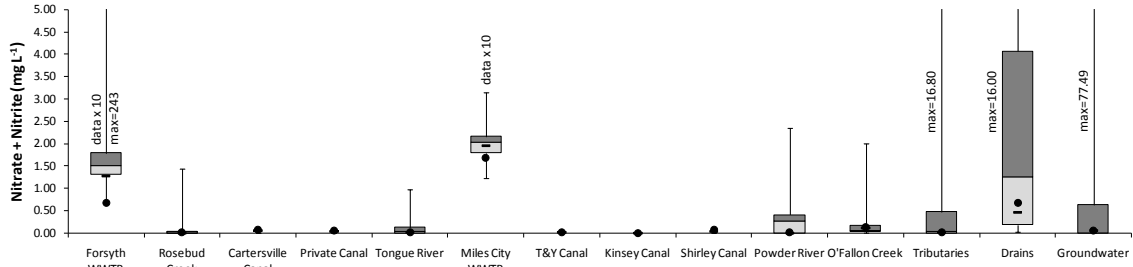

2

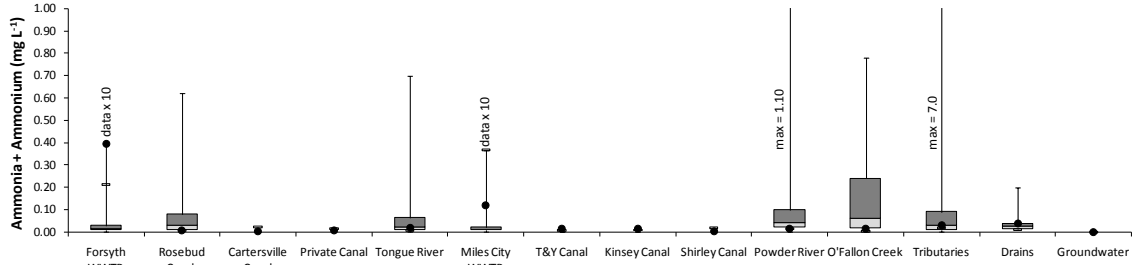

3

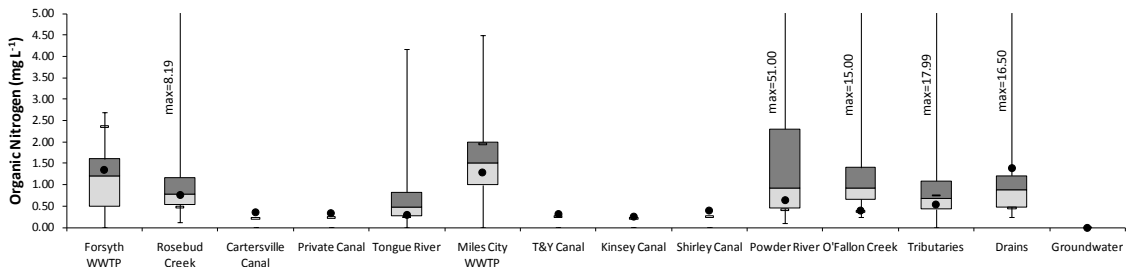

4

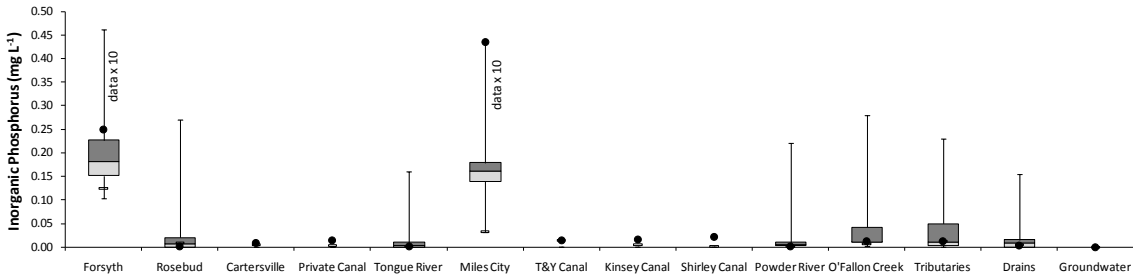

5

6

7

8

9

10

Figure 7-14 (continued). Comparative water quality inflow plots for the Yellowstone River.

● August data — September data

In review of the previous figure, it is important to note that some data were not actually field-measured but were estimated. This is particularly true for unmeasured tributaries, waste drains, and groundwater. To assist the reader, methodologies to derive these concentrations are detailed below. Geometric means were used in all instances to reduce the right-skew bias.

Estimates for unmeasured tributaries were taken from the sites identified in **Table 7-10** (shown previously). Laboratory measurements were compiled and were pooled as shown in **Table 7-21**. Geometric means for August and September were used in the modeling

Table 7-21. Unmeasured tributary water quality data summary (1973-2007).

Monitoring Period ¹	Temperature (°C)	pH	SC (µS cm ⁻¹)	DO (mg L ⁻¹)	TSS (mg L ⁻¹)	TN (mg L ⁻¹)	NO ₂ +NO ₃ (mg L ⁻¹)	TP (mg L ⁻¹)	SRP (mg L ⁻¹)
1973-2007 Max	34.0	9.20	7000	15.2	21,800	19.0	16.8	0.97	1.8
1973-2007 Min	0.0	7.13	101	3.21	1	0.12	ND ¹	ND ¹	ND ¹
1973-2007 Average	12.0	8.31	2699	9.77	980	1.57	0.64	0.23	0.06
August Geometric Average	21.5	8.46	2229	8.18	61	0.90	0.02	0.04	0.01
September Geometric Average	15.5	8.65	2473	9.41	50	0.71	0.01	0.04	0.01

¹ND = no data.

Waste drains estimates from previous investigations were used. The Buffalo Rapids Irrigation District routinely sampled for nutrients and field water quality from 1999-2002 (Schwarz, 2002) (n=129 samples). Similarly, Montana State University (MSU) (H. Sessoms, personal communication) made a detailed study of a subset of drains in the Clear Creek, Sand Creek, and Whoopup Creek drainages in 2007 (n=36 observations). Using this information, water quality constituent summaries were identified (**Table 7-22**).

Table 7-22. Irrigation waste-drain water quality data summary (1999-2007).

Monitoring Period ¹	Temperature (°C)	pH	SC (µS cm ⁻¹)	DO (mg L ⁻¹)	TSS (mg L ⁻¹)	TN (mg L ⁻¹)	NO ₂ +NO ₃ (mg L ⁻¹)	TP (mg L ⁻¹)	SRP (mg L ⁻¹)
1999-2007 Max	25.5	8.96	2794	14.12	2082	14.25	16.0	0.97	ND ¹
1999-2007 Min	7.47	7.54	268	4.06	2	0.28	0.03	0.01	ND ¹
1999-2007 Average	16.5	8.21	949	8.49	47	3.61	0.74	0.03	ND ¹
August Geometric Average	18.2	8.20	1007	7.90	159	0.89	0.67	0.03	ND¹
September Geometric Average	15.2	8.30	1020	ND¹	14	0.17	0.46	0.03	ND¹

¹ND = no data.

Groundwater quality estimates were taken from a compilation of the Montana Groundwater Information Center (GWIC) database (MBMG, 2008). Data from the two drainage basins that overlap the study reach were used: (1) 10100001-Yellowstone River between Bighorn River and Powder River

1 and (2) 10100004-Yellowstone River below Powder River. The search was constrained to wells that were
 2 less than 200 feet deep (Smith, et al., 2000) and within 5 kilometers of the river. Estimates are shown in
 3 **Table 7-23**.

4
 5 **Table 7-23. Groundwater water quality data summary for the Yellowstone River.**

Monitoring Period[1]	Temperature (°C)	pH	SC ($\mu\text{S cm}^{-1}$)	DO (mg L^{-1})	Alkalinity (mg L^{-1})	NO_2+NO_3 (mg L^{-1})	TP (mg L^{-1})
1923-2008 Max	21.5	8.71	6970	12.19	1818	77.49	ND
1999-2007 Min	9.1	4.40	493	0.06	122	0.01	ND
1999-2007 Average	12.1	7.49	2121	1.14	609	2.89	ND
August Geometric Average	11.7	7.50	1824	0.44	560	0.06	ND
September Geometric Average	11.7	7.50	1824	0.44	560	0.06	ND

6
 7 **7.6.2 Nutrient Load Estimates to the River**
 8

9 The site water quality (mg L^{-1}) from this section and measured inflow rates ($\text{m}^3 \text{s}^{-1}$) from **Section 7.2**
 10 were used to make nutrient load estimates to the river. Loads were calculated for both soluble and
 11 organic forms, where soluble nutrients reflect the summation of nitrate and nitrate and aqueous
 12 ammonia (NO_2+NO_3 , NH_4) for the N species and the only form of soluble P is soluble reactive
 13 phosphorus (SRP). The organic fraction in the model reflects the TN or TP measurement minus soluble
 14 nutrients or intracellular nutrients bound within the phytoplankton.

15
 16 Our estimates are shown in **Figure 7-15**. In review, the primary contribution of soluble N was the
 17 headwater boundary condition (66.9%) followed by irrigation waste drains (19.3%) and WWTPs (6.1%)¹.
 18 The primary contribution of soluble P was from the headwater boundary condition (47.1%), WWTPs
 19 (36.2%), and irrigation return flow (4.3%). The greatest organic loads came from the headwater
 20 boundary (68.8-73.8%), to lesser extent waste-drain accretions (2.7-14.5%), and finally the Powder River
 21 (19.3%). Thus the headwater boundary condition is a major factor in the nutrient load contribution to
 22 the project reach.

¹ In regard to the irrigation waste drains, these values are estimates only. During model calibration, it was identified that the contribution of N from waste-drains was likely over-estimated. This is a consequence of two things: (1) uncertainty in the flow estimates made by DEQ (recall that they were estimated using the relationship between irrigated area and return flow measured by MSU); and (2) uncertainty about the quality of water originating from these drains (the water quality estimates were made from data from 1999-2007 and were highly variable between sites). DEQ felt the most objective thing to do would be to include these estimates in the model but calibrate them down.

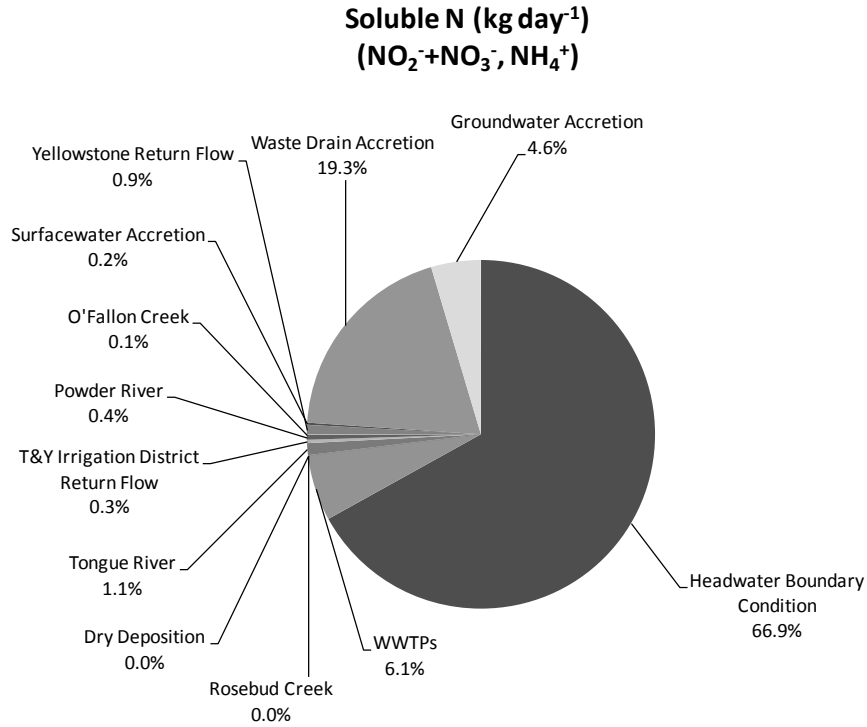

1

Organic N (kg day⁻¹)

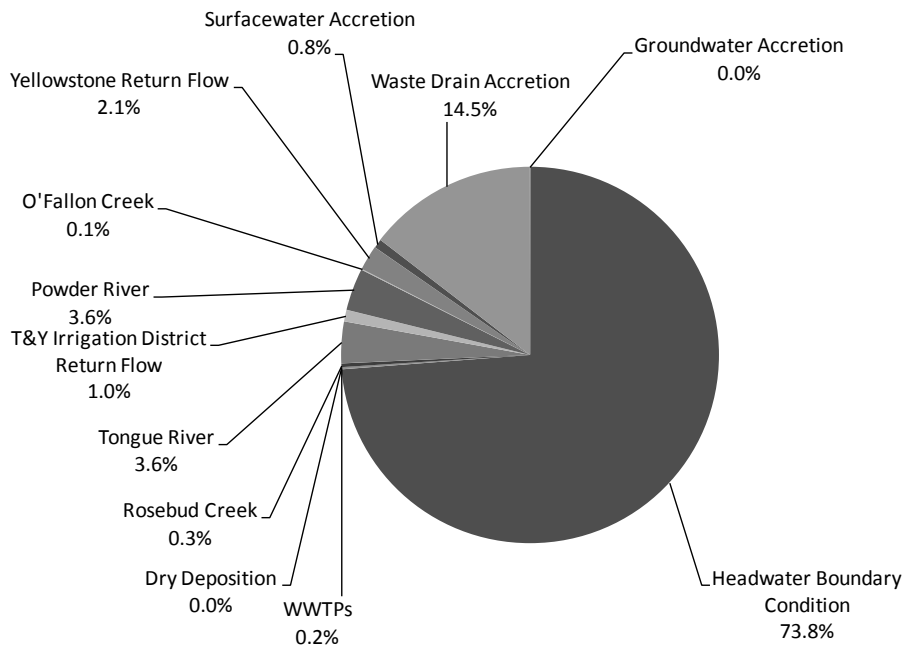

2
3
4

Figure 7-15. Estimated nitrogen contributions to the lower Yellowstone River during 2007.

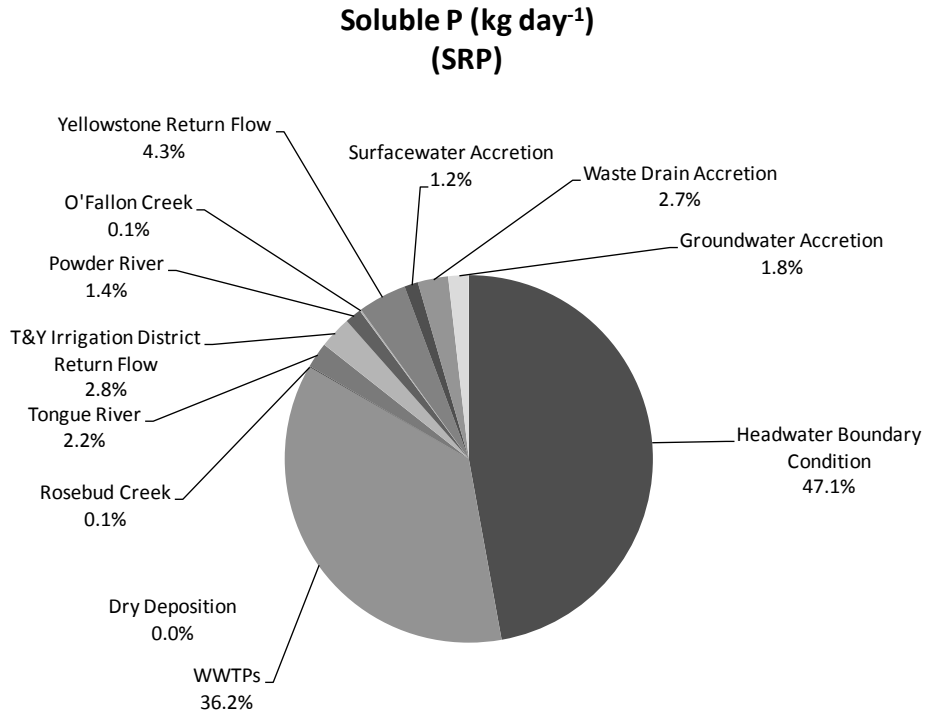

1

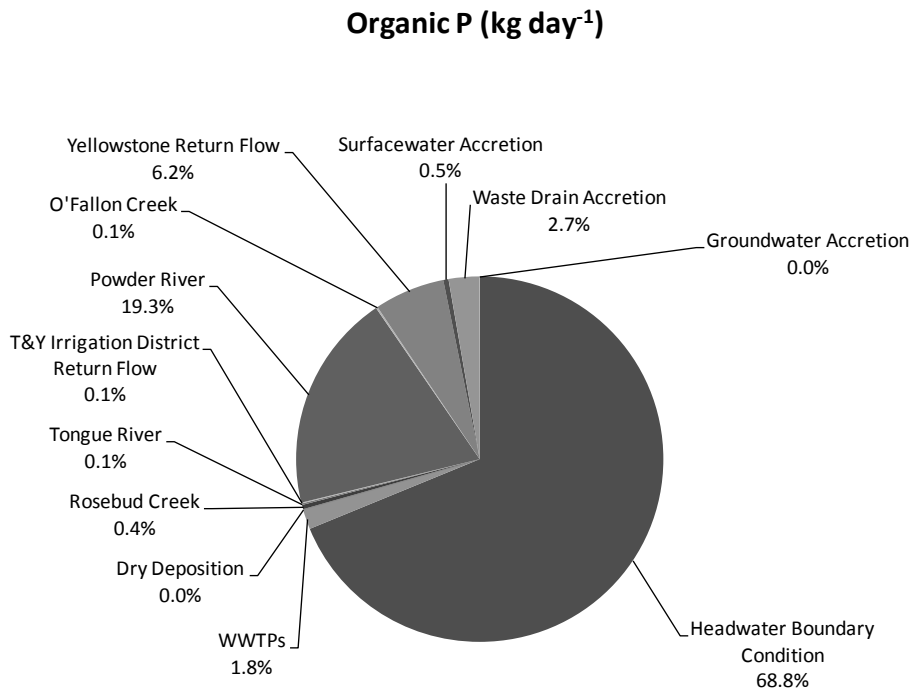

2
3
4

Figure 7-16. Estimated phosphorus contributions to the lower Yellowstone River during 2007.

7.7 Data Uncertainty

We have reviewed an extensive amount of data and clearly there is uncertainty present in many of these estimates. The extent depends on the type of measurement, methodology, and in some cases, whether the value was measured at all (as opposed to estimated). We will address aspects of this uncertainty in the Monte Carlo simulation described in **Section 14.0**. For the interim, we use the literature to make some general characterizations about data uncertainty. Work by Harmel, et al., (2006) is probably most applicable, and estimates of typical uncertainty associated with water quality data is shown in **Table 7-24** (along with similar information regarding our field instrumentation). These estimates will be referred to later on in the document.

Table 7-24. Probable error range in sample collection, storage, preservation, and analysis.

Measurement	Probable Error Range ($\pm\%$)	Source
Dissolved Oxygen	2% or 0.2 mg L ⁻¹	YSI manual (2009)
pH	0.2 units	YSI manual (2009)
Temperature	0.15 °C	YSI manual (2009)
Conductivity	0.5% or 1 $\mu\text{S cm}^{-1}$	YSI manual (2009)
Chlorophyll a - Phytoplankton	0.1% or 0.1 $\mu\text{g L}^{-1}$	YSI manual (2009)
Chlorophyll a - Benthic algae	30%	DEQ (2011)
Streamflow	10	Harmel et al. (2006) ¹
TN	29	Harmel et al. (2006)
NO ₂ +NO ₃	17	Harmel et al. (2006)
Ammonia	31	Harmel et al. (2006)
TP	30	Harmel et al. (2006)
SRP	23	Harmel et al. (2006)
TSS/VSS/Detritus	18	Harmel et al. (2006)

¹Harmel, et al. (2006) – Typical scenario average results.

8.0 SUPPORTING INFORMATION FOR THE CALIBRATION

A great deal of other work went into model development. Supporting information for the calibration is found in this section. Included is a summary of model sensitivity, rate coefficient estimates, and literature supporting these determinations.

8.1 Sensitivity Analysis

A sensitivity analysis was carried out to identify the most important (i.e., sensitive) model parameters [as recommended in the literature (Brown and Barnwell, 1987; Drolc and Koncan, 1999; Paschal and Mueller, 1991)]. We completed ours using QUAL2K-UNCAS (Tao, 2008), which is a re-write of the original QUAL2E-UNCAS (Brown and Barnwell, 1987). In this application, parameter sensitivity is expressed as a normalized sensitivity coefficient (SC) (Brown and Barnwell, 1987) which is identified as the change in model output with change in input (**Equation 8-1**) where ΔX_i = the change in the model input variable X_i and ΔY_o = change in the model output variable Y_o .

(Equation 8-1)

$$SC = \frac{\Delta Y_o / Y_o}{\Delta X_i / X_i}$$

Sensitivity was evaluated using a one-variable-at-a-time perturbation approach with an assigned magnitude of $\pm 25\%$. Results are shown in **Table 8-1** for DO, pH and benthic algae and **Table 8-2** for TN and TP. Two locations of interest were evaluated, an element in the upper reach at river km 150, and one in the lower reach at km 50. They reflect the different character of the river above and below the Powder River.

From our analysis, parameter sensitivities were somewhat surprising¹. For DO and pH, stoichiometry parameters (STOCARB and STOCHLOR) were the most sensitive which illustrates the importance of these values toward photosynthesis. Other sensitive rates included benthic algal subsistence quota (which is directly related to algal growth), CBOD oxidation rate (influences DO dynamics), and organic N hydrolysis rate (affects algal growth in soluble N deficient areas). Phytoplankton growth rate was also important due to its indirect influence on benthic algae. Boundary conditions yielded the highest sensitivities though, and these were primarily initial condition or air or water related.

For TN and TP, there were no rate coefficients of significance (<0.00). This is related to the fact that the rates do not change the total amount of nutrients in the system, only their form (i.e., organic or inorganic). Thus boundary conditions again were most important, primarily headwater TN and TP as well as phytoplankton internal N and P and in some instances point source load influent flow (for TP).

¹ This discussion focuses only on DO and pH. Many of the benthic algal rates are independent variables in the algal mass balance and thus their significance relative to the other variables is misleading.

Table 8-1. Model sensitivities of the lower Yellowstone River Q2K model for DO, pH, and algae.Evaluations completed at the $\pm 25\%$ level. The most sensitive parameters relative to DO, pH, and algae in bold.

Parameter ¹	Units	State-variable Sensitivity at km 150			State-variable Sensitivity at km 50		
		DO	pH	Benthic Algae	DO	pH	Benthic Algae
Rate Coefficients							
BALFACTP	Internal P half-sat. constant	0.02	0.01	0.25	0.00	0.00	0.02
BALG DET	Death rate	-0.06	-0.02	-1.82	-0.02	-0.01	-1.84
BALG GRO	Max Growth rate	0.04	0.02	0.50	0.01	0.01	0.50
BALG MAXN	Maximum uptake rate for N	0.00	0.00	0.01	0.02	0.01	0.85
BALG MAXP	Maximum uptake rate for P	0.07	0.02	0.90	-0.01	0.00	0.27
BALGQTAN	Subsistence quota for N	0.00	0.00	0.00	-0.04	-0.03	-1.01
BALGQTAP	Subsistence quota for P	-0.08	-0.03	-0.85	0.00	0.00	-0.50
BALLFACT	Light constant	-0.03	-0.01	-0.32	-0.01	-0.01	-0.42
BALNFACT	External N half-sat. constant	0.00	0.00	-0.01	-0.02	-0.01	-0.77
BALPFACT	External P half-sat. constant	-0.06	-0.02	-0.82	0.01	0.00	-0.07
FBODDECA	Fast CBOD oxidation rate	-0.05	-0.02	0.00	-0.04	-0.03	0.00
NH2 DECA	OrgN hydrolysis rate	-0.01	0.00	-0.01	0.05	0.03	1.17
PHYFACTN	Internal N half-sat. constant	0.00	0.00	-0.05	-0.02	-0.01	-0.72
PHYFACTP	Internal P half-sat. constant	-0.04	-0.01	-0.62	0.00	0.00	-0.02
PHYNFACT	External N half-sat. constant	0.00	0.00	0.03	0.02	0.01	0.75
PHYPFACT	External P half-sat. constant	0.04	0.01	0.55	0.00	0.00	0.02
PHYT GRO	Max Growth rate	0.03	0.01	-0.84	-0.02	0.00	-2.86
PHYT MAXN	Maximum uptake rate for N	0.00	0.00	-0.07	-0.03	-0.02	-0.98
PHYT MAXP	Maximum uptake rate for P	-0.04	-0.01	-0.65	0.00	0.00	-0.04
PHYTQTAN	Subsistence quota for N	-0.01	0.00	0.26	-0.01	-0.01	0.54
PORG HYD	Organic P hydrolysis rate	0.06	0.02	0.95	0.00	0.00	0.38
STOCARB	Carbon stoichiometry	0.12	0.04	0.00	0.06	-0.05	-0.01
STOCHLOR	Chlorophyll stoichiometry	-0.12	-0.04	0.12	-0.06	0.05	0.09
Boundary Conditions							
AIR_TEMP	Air temperature	-0.08	0.01	0.39	-0.12	0.00	0.25
HWTRALKA	Headwater alkalinity	0.00	0.01	0.00	0.00	0.04	0.01
HWTRBODF	Headwater CBODfast	-0.05	0.03	0.00	-0.03	0.03	0.01
HWTRDETR	Headwater detritus	-0.02	0.01	0.01	-0.01	0.01	0.07
HWTRDISP	Headwater dissolved P	0.03	0.01	0.35	-0.01	0.00	0.05
HWTRFLOW	Headwater flow	-0.01	0.02	0.28	0.00	0.01	0.26
HWTRFYTO	Headwater phytoplankton	-0.06	0.02	1.19	-0.02	0.02	1.13
HWTRNH2N	Headwater organic N	-0.01	0.00	0.01	0.04	0.02	0.88
HWTRNO3N	Headwater nitrate-N	0.01	0.00	0.04	0.01	0.01	0.21
HWTRPH	Headwater pH	0.00	0.55	0.00	-0.01	0.40	0.16
HWTRPINT	Headwater internal P	0.05	0.01	0.68	0.00	0.00	0.02

Table 8-1. Model sensitivities of the lower Yellowstone River Q2K model for DO, pH, and algae.Evaluations completed at the $\pm 25\%$ level. The most sensitive parameters relative to DO, pH, and algae in bold.

Parameter ¹	Units	State-variable Sensitivity at km 150			State-variable Sensitivity at km 50		
		DO	pH	Benthic Algae	DO	pH	Benthic Algae
HWTRPORG	Headwater organic P	0.06	0.01	0.84	-0.01	0.00	0.04
HWTRTEMP	Headwater temperature	-0.21	0.00	0.62	-0.08	0.02	0.38
PH/PRESS	Partial pressure of CO ₂	0.00	0.04	0.00	0.00	0.04	0.00
PTLDFLOW	Point load flow	0.00	0.00	0.06	-0.02	0.00	0.10

¹ BAL = benthic algae, PHYT = phytoplankton, PORG = organic phosphorus, FBOD = fast CBOD**Table 8-2. Model sensitivities of the lower Yellowstone River Q2K model for TN and TP.**Evaluations completed at the $\pm 25\%$ level. The most sensitive parameters relative to TN and TP in bold. All rate coefficients were insignificant.

Parameter ¹	Units	State-variable Sensitivity at km 150		State-variable Sensitivity at km 50	
		TN	TP	TN	TP
Rate Coefficients					
Insignificant		All sensitivities <0.00			
Boundary Conditions					
HWTRDISP	Headwater dissolved P	0.00	0.07	0.00	0.05
HWTRFLOW	Headwater flow	0.05	0.02	0.06	-0.16
HWTRNH2N	Headwater OrgN	0.60	0.00	0.52	0.00
HWTRNH3N	Headwater ammonia	0.02	0.00	0.02	0.00
HWTRNINT	Headwater internal N	0.13	0.00	0.11	0.00
HWTRNO3N	Headwater nitrate	0.19	0.00	0.16	0.00
HWTRPH	Headwater pH	-0.01	0.00	-0.02	0.00
HWTRPINT	Headwater internal P	0.00	0.33	0.00	0.22
HWTRPORG	Headwater OrgP	0.00	0.52	0.00	0.36
PTLDDISP	Point load dissolved P	0.00	0.01	0.00	0.03
PTLDFLOW	Point load flow	0.03	0.08	0.12	0.25
PTLDNH2N	Point load OrgN	0.01	0.00	0.05	0.00
PTLDNO3N	Point load nitrate	0.00	0.00	0.01	0.00
PTLDPINT	Point load internal P	0.00	0.01	0.00	0.01
PTLDPORG	Point load OrgP	0.00	0.03	0.00	0.11

Longitudinal differences in sensitivity were also considered. These are shown in **Figure 8-1**. For both DO and pH, the upper river tends to be most sensitive to upstream boundary conditions although their importance tends to decrease in the downstream direction (with the exception of air temperature). In contrast, rate sensitivity tends to increase in the downstream direction, but is affected by site specific dependencies (such as localized areas of algal growth, nutrient limitation, etc.). Generally from this analysis we can say that initial condition error declines in the downstream direction whereas parameter sensitivity tends to grow. This effect will be detailed further in the uncertainty analysis.

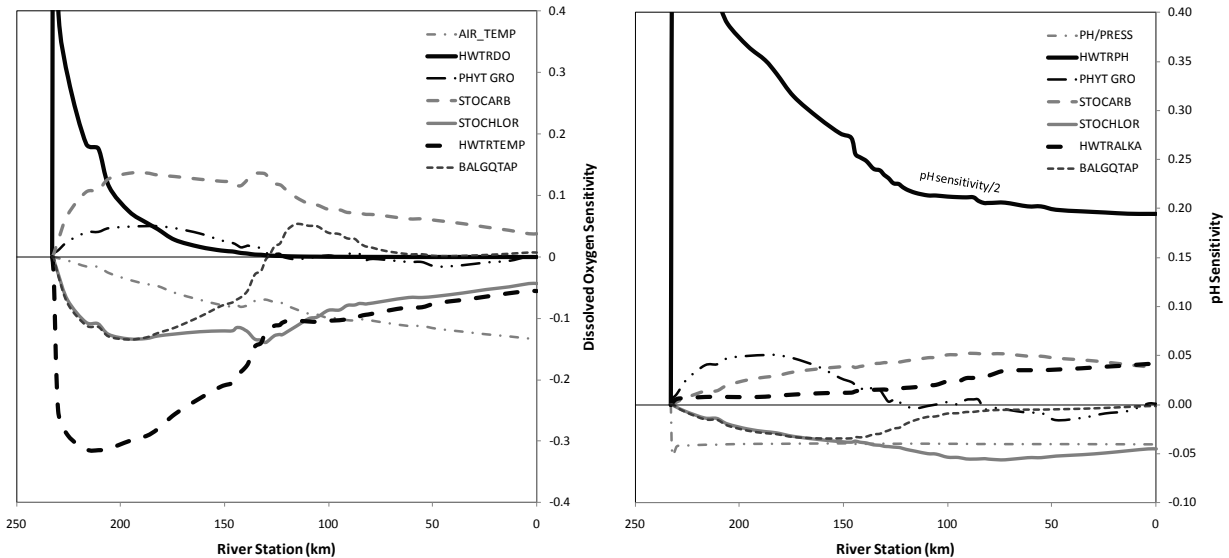

Figure 8-1. Longitudinal sensitivities of selected model rates and forcings for DO and pH.

(Left) Model sensitivities in relation to DO. (Right) Same but for pH.

8.2 Algal Taxonomy and Composition

Information on algal taxonomy was also acquired during 2007 and is useful in characterizing algae including species composition (i.e., diatoms versus filamentous algae), life cycle, mode of nutrient uptake (e.g., autotroph, heterotroph, nitrogen fixer, etc.), expected growth rates, and related information. The Yellowstone River has been well characterized in the past (Bahls, 1976b; Charles and Christie, 2011; Peterson and Porter, 2002), and from this information we have made some general conclusions regarding the river.

First, algal type differs longitudinally. In the upper regions of the river (i.e., from Billings upstream) benthic algae are the primary producers. This is based on the fact that high benthic algal accumulations have been observed in this vicinity, sometimes at concentrations greater than $800 \text{ mg Chl } a \text{ m}^{-2}$. In the lower river, phytoplankton are more abundant (Peterson, 2009; Peterson and Porter, 2002). They either dominate or co-dominate the river. A shift between functional group most likely occurs below the Powder River marking transition between phytoplankton and benthic algal dominance.

The species composition of the Yellowstone River is primarily division Bacillariophyta (diatoms) and *Cladophora* spp. (Bahls, 1976b). Diatoms seemingly dominate the net plankton of the river while *Cladophora* spp. and diatoms fairly evenly co-dominate the periphyton (Charles and Christie, 2011; PANS, 2008). Frequency of algal occurrence is shown in **Table 8-3** [from net collections, (Bahls, 1976b)] and from this we can conclude that little distinction can be made between the plankton and periphyton flora of the river. Hence, most of the suspended algae are of benthic origin. In previous surveys, very few aquatic macrophytes were observed, largely confirming that algae are the river's main primary producers. DEQ did not observe any macrophytes (i.e., vascular aquatic plants) during its work in 2006, 2007, or 2008.

Table 8-3. Percent frequency of algae taxa occurrence in the Yellowstone River.

From Bahls (1976).

Taxa ¹	Periphyton (% of taxa)	Plankton (% of taxa)
Bacillariophyceae (Diatoms)	44	56.6
<i>Cladophora glomerata</i>	47.5	29.2
Enteromorpha	3.6	0.9
Spirogyra	2.8	0.9
<i>Hydrurus foetidus</i>	0.7	1.8
<i>Stigeoclonium</i> spp.	0.7	0.9

¹From 299 total periphyton and phytoplankton samples collected at 49 stations in the river.

8.3 Detached Drifting Filamentous Algae

Large amounts of detached and drifting filamentous algae were observed during 2007. These were mostly *Cladophora* spp., which, according to field productivity experiments, were still photosynthetically viable. To estimate the relative contribution of this detached drifting filamentous algae to net areal benthic biomass, samples were captured using a screen with a fixed area. The screen was placed in the river perpendicular to flow for a known duration of time (area of screen was 0.3364 m², ~4ft²) and care was taken to assure that the measurement location did not have velocities so fast that water would be shunted around the screen, or so slow that algae wouldn't be in suspension. The experiment was halted before algae buildup altered the localized flowlines. Following the algal collection, velocity was measured at the center of the screen.

The net catch was normalized to mg Chl a m⁻² units according to the area of the screen, accumulated or emigrated chlorophylla biomass (mg Chl a m⁻³), and the total water volume that passed through the screen (by using the velocity, time, and screen area). This allowed areal biomass (mg Chl a m⁻²) to be estimated. In all instances (three different sites measured), the floating algae contribution was negligible. Measurements at the Highway 59 Bridge, Calypso Bridge, and Bell St. Bridge were all 0.02 mg Chl a m⁻². Consequently, detached, drifting filamentous algae was not considered in the modeling.

8.4 Stoichiometry of Algae

As shown in the sensitivity analysis, the stoichiometry of algae is an integral part of the carbon (C), nitrogen (N), phosphorus (P), and oxygen (O) mass balance in Q2K. As algae die, hydrolytic bacteria quickly reduce organic materials into simpler compounds and recycle nutrients into their respective pools (at specified mass ratios and rates). In most modeling studies, the Redfield ratio (Redfield, 1958) is used due to a lack of better site specific data (Kannel, et al., 2006; Turner, et al., 2009). However for DEQ's purposes, site specific estimates were preferable. Suspended seston samples were therefore collected at a number of locations during both August and September 2007 to meet this data need. Samples were analyzed for particulate C, N, P, ash free dry mass (D), and chlorophyll a (Chl a).

Unfortunately raw river water contains both living and nonliving organic material, hence detrital corrections were necessary to estimate the contribution of live algae. Corrections were made through linear regression of particulate organic C, N, P, and D (all in mg L⁻¹) with suspended Chl a (mg L⁻¹) where

1 the ordinate of the best-fit line gives an estimate of the concentration not derived from phytoplankton
2 (Hessen, et al., 2003). This is shown in **(Equation 8-2)**, where x = slope and b = y-intercept.

3
4 **(Equation 8-2)**
$$y = xChla + b$$

5
6 Estimates were made under the assumption that the slope of the regression line could be used to
7 calculate individual ordinates for each x,y pair and provide a unique detrital estimate for each sampling
8 site¹. From this approach, detrital contributions for the Yellowstone River ranged from 35-57% in August
9 and 63-85% in September. They averaged 47% for August and 73% for September ($r^2=0.30-0.73$, **Figure**
10 **8-2**), so there was more live algae in August (53%) than September (27%)².

11
12 Overall stoichiometry (by mass) for the river was: 107 g AFDM: 43g C: 4.7 g N: 1 g P: 0.8 g Chla for
13 August, and 104 g AFDM: 42g C: 4.5 g N: 1 g P: 0.8 g Chla for September. Values fall roughly into the
14 range of C:N:P values reported in the literature for benthic algae, for example 61:8.1:1(Kahlert, 1998)
15 and 46 :7.7:1 (Hillebrand and Sommer, 1999), and are slightly lower than the Redfield ratio (40:7.2:1)
16 (Redfield, 1958).

17
18 Several conclusions can be made from the stoichiometry estimates. First, the moderately low N:P ratios
19 (N:P<5.9 mass weight) and relatively high C:N ratios (C:N>8.6 mass weight) are suggestive of moderate
20 nitrogen limitation of phytoplankton (Goldman, et al., 1979; Hillebrand and Sommer, 1999). This
21 interpretation is supported by the taxonomic findings of Peterson and Porter (2002) and Charles and
22 Christie (2011) (but for benthic algae) who note a large proportion of nitrogen fixers in the lower parts
23 of the river (sometimes in excess of 30%). Conclusions by Klarich (1977) and Benke and Cushing (2005)
24 suggest similarly that N is limiting.

25
26 In our case, conclusions are probably only valid for the floating algae for two reasons. First, the
27 analytical work for C:N:P was only for suspended algae. Second, soluble phosphorus levels in the river
28 were very low in 2007 (2.6-3.7 $\mu\text{g L}^{-1}$), which suggests at least at some level P limitation for the benthic
29 algae (Bothwell, 1985), or perhaps co-limitation. Additional discussions regarding this topic, as well as
30 nutrient limitation in general is found in the modeling. These initial suggestions are provided only to give
31 a general interpretation of the river.
32

¹ The ratio of ash-free dry mass (AFDM) and Chla against other constituents (i.e., C, N, P) is the least reliable part of the detrital correction. For example, the C:N:P ratio remains fixed regardless of the detrital adjustment (i.e., it remains the same both before and after the correction), however the relation to Chla and AFDM could vary. We feel that these ratios could lie anywhere between the unadjusted and fully corrected ratios.

² The detrital contributions determined from this method were similar to those suggested by Bahls (1974) during non-productive conditions (e.g., comparing our September to his April). During his analysis, he found 85-90% of the suspended seston in the river was unidentifiable pieces of organic detritus.

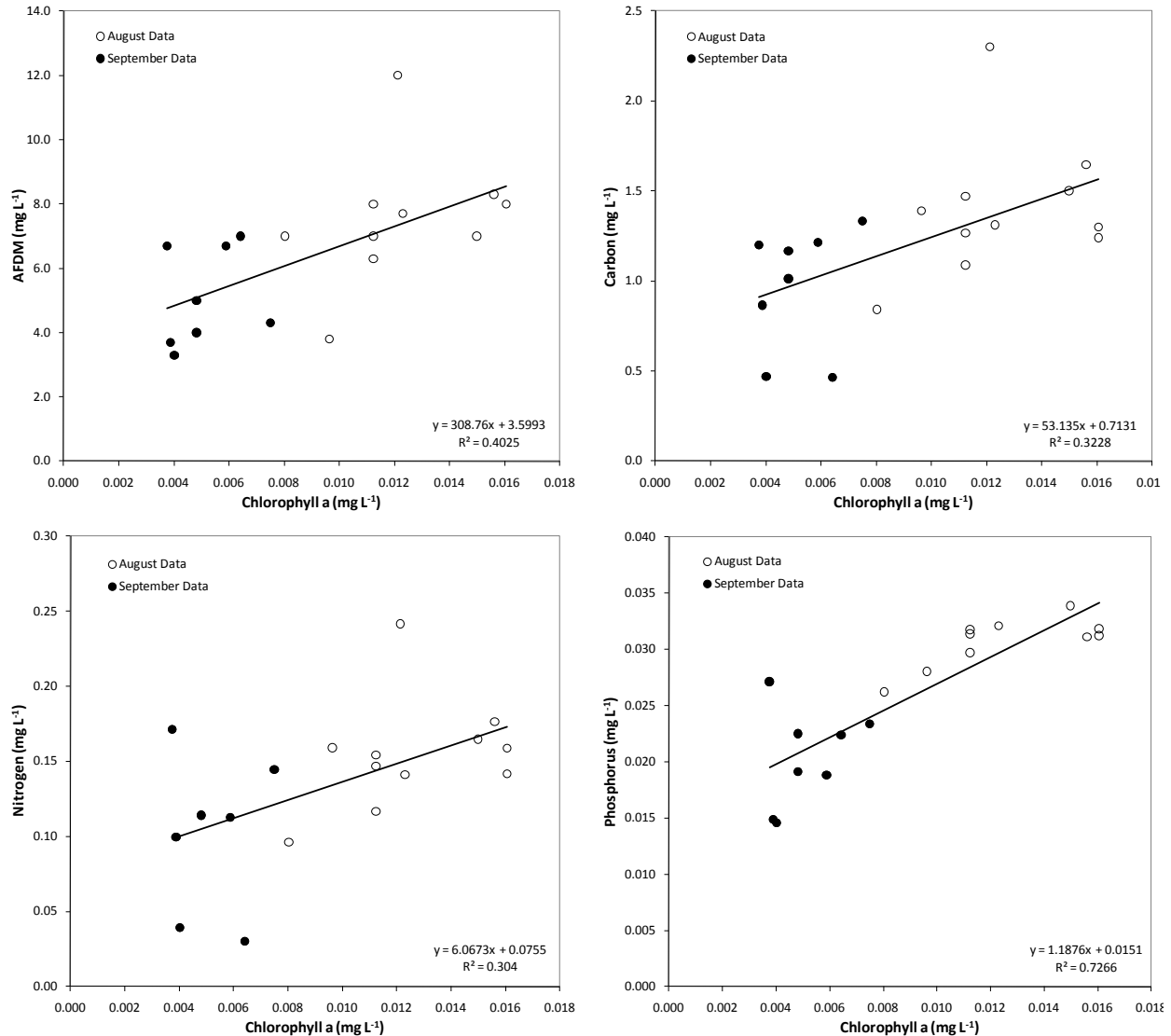

1

2

3

4 **Figure 8-2. Stoichiometric C:N:P regression relationships for the Yellowstone River.**

5 Note: One September data point was adjusted and one was removed due to inconsistent results. This was done as
6 the carbon and AFDM values for this sample were anomalous compared to all of the other observations for the
7 time period (e.g. ratio nearly double).

8

9 **8.5 Algal Growth Rate Experiments (Light-Dark Bottles)**

10

11 Field estimates of gross primary productivity and respiration were made in 2007 using light-dark bottles
12 (Suplee, et al., 2006b). Gross specific growth rates were calculated according to Auer and Canale (1982a)
13 (**Equation 8-3**), where μ_{net} is the net specific growth rate (day⁻¹), P_{net} is the net photosynthetic rate
14 (mgO₂ L⁻¹ day⁻¹), C is the measured carbon content in the bottle (mg C L⁻¹), and P_q is the photosynthetic
15 quotient. A photosynthetic quotient of 1.2 (i.e., 1 mole of C fixed per 1.2 mole of O₂ generated) was
16 used (Wetzel and Likens, 1991).

17

1 (Equation 8-3)

$$\mu_{net} = \frac{P_{net}}{C} \bullet P_q$$

2
3 Specific growth rate measurements on the Yellowstone River were between 1.3-2.5 day⁻¹ in August and
4 0.7-1.5 day⁻¹ in September (**Figure 8-3**) which is within the expected range for phytoplankton (Chapra,
5 1997; Thomann and Mueller, 1987). Temperatures during these periods were 21°C and 16°C,
6 respectively and adjustment to the standard temperature of 20°C [$\theta=1.07$, from (Eppley, 1972)] yielded
7 estimates ranging from 0.9-2.3 day⁻¹. Consequently, the maximum unlimited growth rate in the model¹
8 was estimated to be 2.3 day⁻¹.
9

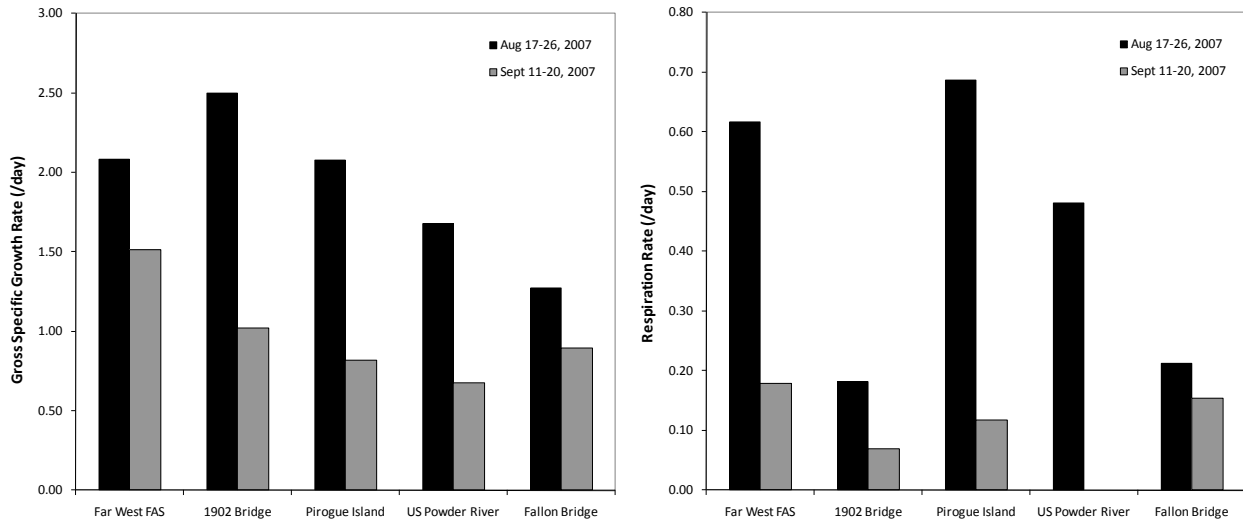

10
11 **Figure 8-3. Primary productivity and respiration measurements on the Yellowstone River in 2007.**

12 There is a strong downstream decrease in productivity which is linked directly with river turbidity (and perhaps
13 soluble nutrients to a lesser extent given the fact that nitrogen happened to be limiting phytoplankton).
14 Respiration followed a similar trend, ranging from 0.2-0.7 day⁻¹ in August and 0-0.2 day⁻¹ in September
15 (temperature corrected rates, 0-0.6 day⁻¹). Generally these rates were higher than expected (Chapra, 1997;
16 Thomann and Mueller, 1987) and were believed to be at least partially due to the fact that they were not
17 corrected for non-algal BOD (BOD decay rates in the river are believed to be on the order of 0.2 day⁻¹).
18

19 Rates of benthic algal growth were not obtained but are believed to be lower than phytoplankton (Auer
20 and Canale, 1982b; Borchardt, 1996; Bothwell, 1985; Bothwell, 1988; Bothwell, 1989; Bothwell and

¹ The maximum unlimited growth rate is the photosynthetic rate absent of any light or nutrient limitation (i.e., the fastest rate at which the algae could ever grow). Our field estimates are believed to be very close to the maximum unlimited growth rate for two reasons. First, the bottles were placed in ~0.15 meters (0.5 feet) meters of water so they were absent of light limitation. Secondly, C:N:P measurements showed high internal P levels and associated concentrations of N were high in the water column. Therefore nutrient limitation was not likely. Consequently, our field measurements seemed like a reasonable upper threshold for phytoplankton growth.

1 Stockner, 1980; Horner, et al., 1983; Tomlinson, et al., 2010). They are also more difficult to measure.
 2 Because of this, we used the literature to make an initial estimate of the maximum unlimited growth
 3 rate. According to Tomlinson (2010), an upper limit of 1.5 day⁻¹ is a reasonable estimate. Other literature
 4 suggests lower values could occur, but these are not always reflective of maximum unlimited growth
 5 conditions. Hence they are probably underestimates. Rate studies identified by DEQ are shown in **Table**
 6 **8-4** and show fairly consistent results when adjusted for temperature and photoperiod.

7

8 **Table 8-4. Maximum unlimited first-order benthic algae growth rates from the literature.**

Algae Type	Reported Growth Rate (day ⁻¹)	Temperature (°C)	Adjusted to 24 hr lighting and 20°C (day ⁻¹) ¹	Reference	Location
Diatoms	0.50	20	0.86	Klarich (1977)	Yellowstone River, MT
Diatoms	0.61	19.3	1.18	Bothwell and Stockner (1980)	McKenzie River, OR
<i>Cladophora</i>	1.08	19±2	1.08 ²	Auer and Canale (1982b)	Lake Huron, MI
Green algae	0.76	17.5	0.89 ²	Horner et al. (1983)	Lab Flume
Diatoms	0.13	3.0	0.92	Bothwell (1985)	Thompson River, BC
Diatoms	0.54	17.9	1.14	Bothwell (1988)	S. Thompson River, BC
Diatoms	0.38	13.5	0.99	Biggs (1990)	South Brook, New Zealand
Diatoms	0.36	17	0.82	Stevenson (1990)	Wilson Creek, KY
<i>Cladophora</i>	1.53	19±2	1.53 ²	Tomlinson (1982b)	Lake Huron, MI

9 ¹Data adjusted based on estimated photoperiod (range from 10-14 hours).10 ²No adjustment for lighting necessary (24 hr lighting used in experiment).

11

12 In summarizing this compilation, maximum unlimited growth rates range from 0.8 to 1.5 day⁻¹, with a
 13 mean of around 1.0 day⁻¹. Since most of these studies reflect the net specific growth rate (i.e., they are
 14 not corrected for the effects of respiration, death, or scour), estimates are likely low. Hence the initial
 15 estimate of 1.5 day⁻¹ was believed to be a good starting point for calibration. This first-order maximum
 16 unlimited growth rate was then converted to a zero-order growth rate¹ to be consistent with the
 17 method used in the model. By approximating the slope of the exponential portion of the first-order
 18 growth model (**Figure 8-4**), 400 mg Chl_a m⁻² day⁻¹ became our zero-order maximum unlimited growth
 19 rate estimate, similar to that identified by Turner, et al., (2009).

¹ First-order units were converted to zero-order units by approximating the exponential growth phase.

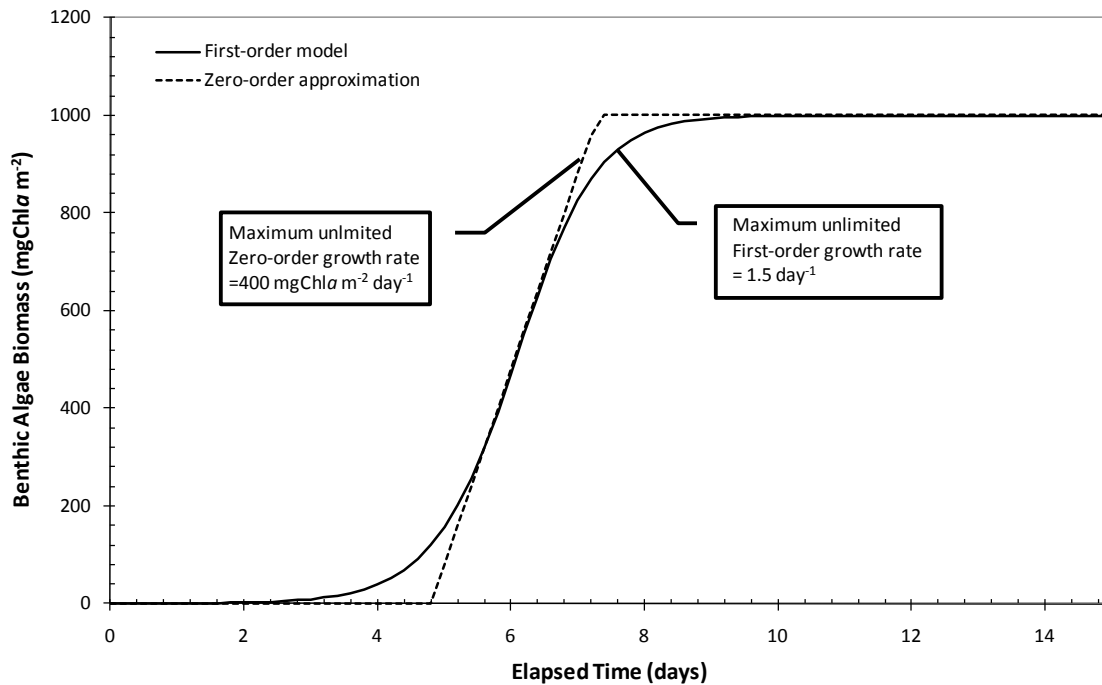
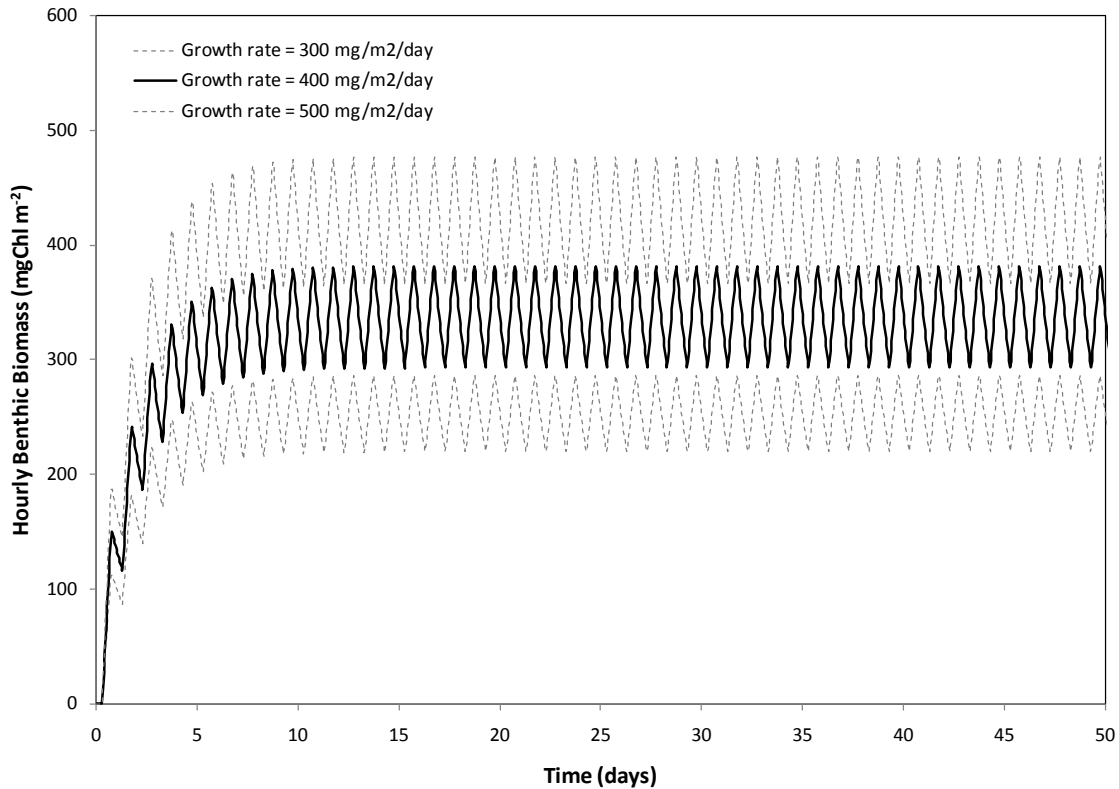

Figure 8-4. Comparison between zero- and first-order maximum unlimited growth estimates.

First-order growth modeled with an initial condition of $0.1 \text{ mg m}^{-2} \text{ Chla}$ (Equation 12-1). The slowing of biomass accumulation over elapsed time is represented as a logistic function for implied space limitation (Equation 12-2, using $1,000 \text{ mgChla m}^{-2}$ as the maximum biomass).

During this analysis, another consideration for the modeling was identified; the ability to reproduce maximum expected biomasses for the Yellowstone River. For diatoms (which were most abundant during 2007) maximum biomasses should be on the order of $300\text{-}400 \text{ mgChla m}^{-2}$ (Stevenson, et al., 1996). However, in the previous plot (which included no limitation terms) simulated equilibrium biomasses were nearer $1,000 \text{ mgChla m}^{-2}$, which was a user specified constraint (otherwise biomass would grow to infinity). To verify the model can indeed reflect the range of biomasses anticipated in the river, we did another algal growth simulation over time, but this time with an assumed biomass loss term (from respiration, death, scour, etc.)¹. Losses were estimated to be 50% based on Tomlinson, et al., (2010) and Rutherford, et al., (2000), and this indicates that a maximum unlimited growth rate of $400 \text{ mgChla m}^{-2} \text{ day}^{-1}$ is a very appropriate value to reach the anticipated maximum biomass levels of $300\text{-}400 \text{ mgChla m}^{-2}$ (Figure 8-5).

¹ In this instance we carried out the simulation using the zero-order algal growth model with assumed loss terms and incoming PAR at 100% (i.e., no light limitation).



1
2 **Figure 8-5. Estimated maximum biomasses with losses but no nutrient or light limitation.**
3 Simulations show that a growth rate of approximately $400 \text{ mg m}^{-2} \text{ day}^{-1}$ is required to meet expected peak diatom
4 biomass under unlimited growth conditions. The daily oscillations reflect the disparity between nighttime
5 respiration and daytime photosynthesis (i.e., photosynthesis overcomes the respiration effect during the daytime
6 and the opposite at night).

7

8 **8.6 Minimum Cell Quota (q_o) Estimates**

9

10 Minimum cell quota (q_o) estimates were made and identify the minimum cellular concentration of N or
11 P necessary for algal growth. According to Shuter (1978), q_o can be estimated for both N and P using cell
12 biovolume (μm^3). From his regression analysis (data from more than 25 algal species), a log relationship
13 exists between cell size and internal N and P concentration which suggests that larger algal cells have
14 higher subsistence quotas and require more N and P than smaller ones). In that study, a very good
15 correlation is observed across a wide range of alga species ($r^2=0.9$) and we used biovolume data
16 collected by USGS during August of 2000 to make these estimates for the Yellowstone River.

17

18 For the broad spectrum of observations in the Yellowstone River during 2000 (i.e., the aggregate algal
19 community), Shuter's (1978) regressions indicate that q_o should be on the order of $2.7 \text{ mgN mgChl}^{-1}$
20 and $0.09 \text{ mgP mgChl}^{-1}$, with a range of 0.87-5.89 for N and 0.0-0.19 for P according to the weighted

1 average of cell sizes in the river during 2000 and the carbon to Chl a ratios found in 2007¹. The ratio of q_o
 2 N and P values (30:1) is much larger than canonical Redfield (7.2:1 mass ratio), but is in agreement with
 3 Klausmeier, et al., (2004) who indicate that the N:P ratio in autotrophic organisms shifts as they near the
 4 cell quota. For example, resource acquisition machinery (i.e., nutrient-uptake proteins and chloroplasts)
 5 is P-poor making the N:P ratio higher nearer the cell quota under nutrient deplete conditions (more like
 6 20-30:1). Whereas assembly machinery for exponential growth under optimal conditions (more like
 7 Redfield) is P-rich (ribosomes) and leads to lower N:P ratios.

8
 9 It should be noted that the coefficient of variation (COV) from Shuter's work is quite low (COV=0.15)
 10 making most of the uncertainty associated with the C:Chl a ratio used in the analysis. In any regard,
 11 estimates are also within the range reported by others (Reynolds, 1993; Shuter, 1978; Stevenson, et al.,
 12 1996) as Reynolds (1993) suggests that q_o for N and P for phytoplankton should be on the order of 3.4-
 13 3.8 mgChl a^{-1} and 0.03-0.59 mgChl a^{-1} , respectively, while Stevenson (1996) indicates it should be 1.41-
 14 1.81 and 0.06-0.4 for N and P for benthic algae (although only one study was reported for N)². Hence,
 15 we are at least at a good starting point for estimating minimum cellular requirements of N and P in the
 16 river.

18 8.7 Algal Nutrient Uptake Estimates

19
 20 Nutrient uptake estimates for algae were made solely through calibration. Since uptake is a function of
 21 both the internal and external nutrient concentrations, it is important to preserve the theoretical
 22 constructs of the model during calibration (Thomann, 1982). Calibration therefore focused on uptake
 23 kinetics which included assignment of maximum uptake rates, internal and external half-saturation
 24 coefficients, and also achieving a good fit with the observed data. Reviews of nutrient uptake kinetics
 25 can be found a number of places (Di Toro, 1980; Droop, 1973; Rhee, 1973; Rhee, 1978) and DEQ relied
 26 heavily on these constructs in model development.

27
 28 In summary, nutrient uptake depends on both internal and external nutrient concentrations where
 29 larger cells (or ones with higher growth rates) require more nutrients than those with smaller cells or
 30 lower growth rates. Counterintuitively larger cells have higher half-saturation constants than smaller
 31 cells and lower growth rates. Di Toro's (1980) work is particularly useful because he establishes
 32 constraints on parameter covariances of uptake factors. Suggested external half-saturation constants for
 33 phytoplankton range from 12-60 $\mu\text{g L}^{-1}$ for P and around 4.2-42 $\mu\text{g L}^{-1}$ for N, while internal half-
 34 saturation constants are an order of magnitude lower. A relationship between maximum unlimited
 35 uptake rate and maximum unlimited growth rate was also defined³, where the dimensionless parameter
 36 β relates the maximum specific uptake rate to maximum growth rate (suggesting the maximum possible

¹ The conversion of units to mgA (Chl a) was completed with an assumed 43:0.4-0.8 ratio between carbon and chlorophyll.

² All literature conversions assumed a 100:1 ratio between sample dry weight and Chl a content (e.g., all original values were reported in N or P per unit dry weight).

³ This ratio is defined as follows: $V_m = \beta(q_o\mu'_m)$, where V_m is the maximum unlimited uptake rate, β is the dimensionless ratio of V_m/q_o , and μ'_m is the maximum unlimited growth rate.

1 variation in cell quota). Values for β are suggested to be on the order of 10 for N and 100 for P
 2 (reflecting a greater capacity of uptake for P as opposed to N). The internal half-saturation constant K_q
 3 can subsequently be estimated from q_o . We used a ratio of 1.0 for N and 0.5 for P which is
 4 recommended by Di Toro (1980) and others (Droop, 1973; Rhee, 1973; Rhee, 1978). Given the variability
 5 of these relationships, our estimates should suffice.

6
 7 One last thing of note regarding uptake kinetics was that we had the unexpected good fortune in 2007
 8 of observing elevated nitrate at the headwater boundary condition at Forsyth. In this regard we got to
 9 observe longitudinal uptake/depletion which was a great benefit to model calibration. This condition
 10 was not present for P, however, because at all times river water quality concentrations were very low
 11 (near the detection limit). Consequently, the literature was relied on heavily which included calculated
 12 q_o 's from Shuter (1978) and internal and external half-saturation constants from Di Toro (1980). These
 13 values were refined through calibration.

14 15 **8.8 Reaeration**

16
 17 Estimates of reaeration were made from the YSI sonde data using the procedures outlined in McBride
 18 and Chapra (2005). The approach is applicable to locations where reaeration coefficients (k_a) are less
 19 than 10 day^{-1} , the photoperiod is 10-14 hrs, and where primary production is well described by a half-
 20 sinusoid. Other factors such as longitudinal gradients in stream temperature or water quality are
 21 assumed constant. The calculation for k_a is shown in **Equation 8-4** where η =the photoperiod correction
 22 factor¹ and ϕ =lag time between solar noon and the minimum DO (McBride and Chapra, 2005):
 23

24 **(Equation 8-4)**
$$k_a = 7.5 \left(\frac{5.3\eta - \phi}{\eta\phi} \right)^{0.85}$$

25
 26 Measurements over a two week period at each sonde location were used to make the reaeration
 27 estimate (i.e., the two weeks surrounding each sampling in August and September). The lag time
 28 between solar noon and the minimum dissolved oxygen deficit (i.e., the maximum DO concentration)
 29 was determined each day and then the temperature specific k_a was calculated accordingly. Photoperiod
 30 (f) and time of solar noon were taken directly from sunrise-sunset tables provided by the National
 31 Oceanic and Atmospheric Administration (NOAA, 2010c) according to site latitude and longitude. Each
 32 k_a was then calculated independently for a single day and the results were averaged for the analysis
 33 period. The computed k_a values were adjusted to standard temperature (20°C) and estimates for the
 34 August and September data collection episodes are shown in **Table 8-5**. A 95% confidence interval (CI)
 35 was also calculated from the mean of the observations.

¹ The photoperiod correction factor is defined as follows: $\eta = \left(\frac{f}{14} \right)^{0.75}$ (McBride and Chapra, 2005)

where f =photoperiod and η is the photoperiod correction factor. The correction factor η was nearly at unity, as photoperiods for the Yellowstone River approximated 14 hours.

1 **Table 8-5. Estimated reaeration coefficients for the Yellowstone River during 2007.**

Sonde	Q2K Station (km)	August k_{a20} (day^{-1})	95% CI $k_{a20} \pm$	September k_{a20} (day^{-1})	95% CI $k_{a20} \pm$
10-Rosebud West FAS	232.9	2.4	1.24	2.5	1.20
20-US Cartersville Canal	184.3	2.6	0.94	2.7	0.86
30-1902 Bridge	147.5	3.4	0.60	5.1	0.93
35-RM 375	133.1	6.9	1.45	---	---
40-Kinsey Bridge FAS	124.2	3.9	1.71	5.9	1.57
50-US Powder River	87.9	3.1	0.76	4.6	1.46
60-Calypto Bridge	80.5	3.6	1.19	3.6	1.29
70-US O'Fallon Creek	55.3	2.9	1.17	5.1	1.48
80-Bell St. Bridge	0	1.9	0.94	2.3	0.80

2 3 4 8.9 Sediment Oxygen Demand (SOD)

5 Sediment oxygen demand (SOD) measurements were made in 2006 using sediment cores incubated at
6 ambient river temperatures. SODs from 2006 are shown in **Table 8-6**. Duplicates ranged from 0.06-0.78
7 $\text{g O}_2 \text{ m}^{-2} \text{ d}^{-1}$, with an overall mean of $0.5 \text{ g O}_2 \text{ m}^{-2} \text{ d}^{-1}$. Our measured values are fairly typical for
8 unpolluted rivers (Bowie, et al., 1985; Edburg and Hofsten, 1973; Uchrin and Ahlert, 1985) and low
9 relative to rivers with heavy pollution (Uchrin and Ahlert, 1985). Results suggest that the Yellowstone
10 River has fairly low organic content and low SOD.

11 **Table 8-6. SOD from the Yellowstone River measured via core incubations.**

Location	SOD ($\text{g O}_2 \text{ m}^{-2} \text{ d}^{-1}$)	Mean ($\text{g O}_2 \text{ m}^{-2} \text{ d}^{-1}$)	COV (%)	Approximate Range	
				Min	Max
Roche Jaune FAS Duplicate	0.66 0.35	0.51	43	0.2 ¹ 0.1 ²	1.0 10
Fallon Bridge Duplicate	0.78 0.57	0.67	22		
Richland Park Duplicate	0.43 0.06	0.24	105		

13 ¹ For sand bottoms (Bowie, et al., 1985).

14 ² Approximate range (Bowie, et al., 1985).

15
16 SOD measurements were also made during 2007 using *in situ* benthic SOD chambers after the design of
17 Hickey (1988). Unfortunately, we were unable to derive any useful data from the chambers because we
18 could not get a good seal between the chambers and river bottom (due to the coarse nature of the
19 Yellowstone River's gravel/cobble substrate). DO levels increased inside the darkened chambers even
20 after they were in place during the typical morning-long DO increase in the river from photosynthesis.
21 Thus water outside the chamber was leaking in. Consequently, we were only able to use the 2006
22 sediment core SODs as our field-measured values for the modeling work.

23
24 To go along with the SOD measurements, percent SOD coverage was visually estimated at each field
25 transect. Tabulated cross-sectional averages are provided in **Table 8-7**, and include percent algal cover
26 also. The average of sites was used in the modeling. Given the river variability, values were rounded to
27 the nearest five percent, at 5% for SOD and 90% for benthic algae coverage.

1 **Table 8-7. SOD and algal coverage estimates for Yellowstone River.**

Location	Mean substrate Size (mm)	Class	Estimated cover by SOD (%)	Estimated cover by algae (%)
Far West FAS	59	gravel	0	90
1902 Bridge	38	gravel	5	90
Pirogue Island	53	gravel	0	100
Kinsey Bridge FAS	84	cobble	0	80
Fallon Bridge	49	gravel	5	100
Averages	56	gravel	5	90

2

3 **8.10 Light Extinction and Suspended Particles**

4

5 Light extinction and the influence of suspended particles was also evaluated using the Beer-Lambert law
6 (**Equation 1-1**). The primary variable of interest was the extinction coefficient (k_e), which reflects the
7 collective absorption and scattering of particles in the water column. Chemistry and PAR data from
8 Peterson (2009) were used to identify k_e through rearrangement of **Equation 1-1**¹, where k_e is the slope
9 of the best fit line, z is water depth, and $PAR_{surface}$ is the y-ordinate. Fitted extinction coefficients are
10 shown in **Figure 9-6** for the Yellowstone River and were found to range between 1.3-2.5 m^{-1} ($r^2=0.85-$
11 0.99). They generally increase in the downstream direction.

12

13 k_e can be approximated linearly as the sum of several partial extinction coefficients that are reliant on
14 the concentrations of particles in suspension and their optical attributes (Blom, et al., 1994; Chapra, et
15 al., 2008; Di Toro, 1978; Van Duin, et al., 2001) (**Equation 8-5**), where k_{eb} reflects the extinction due to
16 colloidal color and water (m^{-1}), α_i , α_o , α_p , and α_{pn} are the unique to particle type ($m^2 g^{-1}$), and m_i , m_o ,
17 and a_p are the concentrations of inorganic suspended solids (m_i , $mg L^{-1}$), detritus (m_o , $mg L^{-1}$), and
18 phytoplankton (a_p , $\mu g L^{-1}$) respectively.

19

20 (**Equation 8-5**)
$$k_e = k_{eb} + \alpha_i m_i + \alpha_o m_o + \alpha_p a_p + \alpha_{pn} a_p^{2/3}$$

21

22

¹ $\ln(PAR_z) = k_e z + \ln(PAR_{surface})$

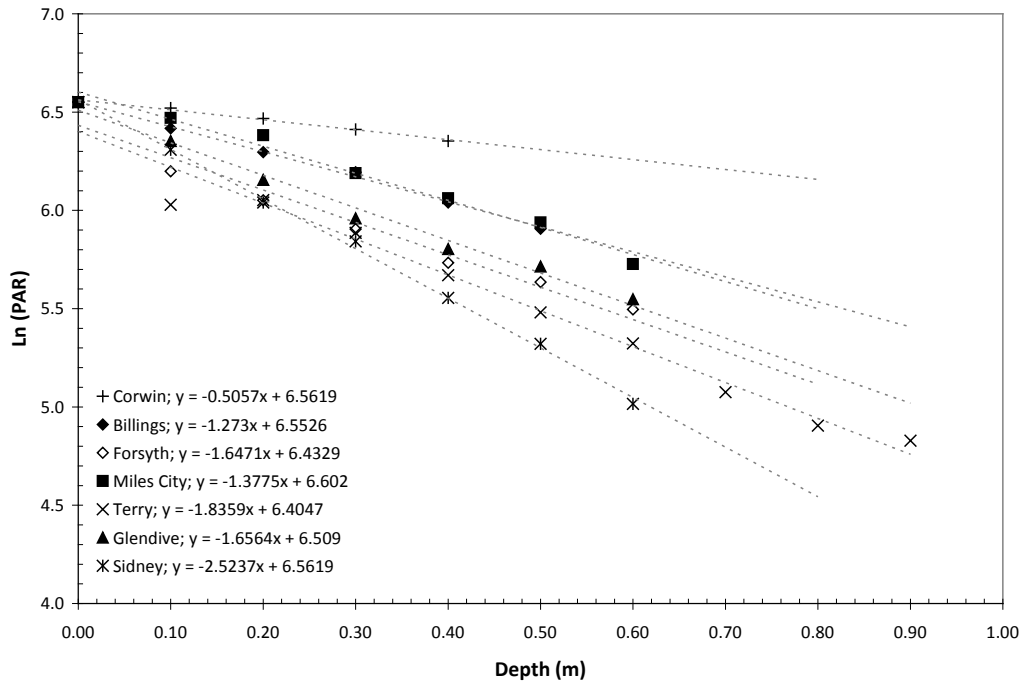

Figure 8-6. Light extinction coefficients calculated for the Yellowstone River.

Extinction values range from 1.3-2.5 m^{-1} in the lower river (Billings to Sidney). Measurements taken in late August or early September by Peterson (2009).

Partial extinction coefficients were determined according to **Equation 8-5**, where the effect of water and color (k_{eb})¹ was first determined using the sum of the partial extinction coefficient of pure water (k_w) and color (k_{color}). k_w was assumed to be that of pure water 0.0384 m^{-1} (Lorenzen, 1972; McPherson and Miller, 1994; Philips, et al., 2000) and the partial attenuation coefficient for color (k_{color})² was calculated using the relationship of 0.014 m^{-1} per platinum-cobalt unit (Pt-Co, a measure of color) (McPherson and Miller, 1994; Philips, et al., 2000). Historical color measurements on the river were used to define the overall color effect in the model. Based on an n=5 and n=11 for the two gages, the estimated true color under low flow conditions was 5.38 Pt-Co units or a k_{eb} estimate³ of 0.114 m^{-1} . Tabulated historical color measurements for the river are shown in **Figure 8-7**. Measurements were consistent (standard deviation=1.4 Pt-Co units) for the most part.

¹ $k_{eb} = k_w + k_{color}$

² A water's color changes based on dissolved aquatic humus, e.g., gilven/yellow substance, see (Davies-Colley, 1992; Kirk, 1994).

³ Calculation is as follows: 5.38 mg L^{-1} Pt-Co \times 0.014 m^{-1} L mg^{-1} (color) + 0.0384 m^{-1} (water).

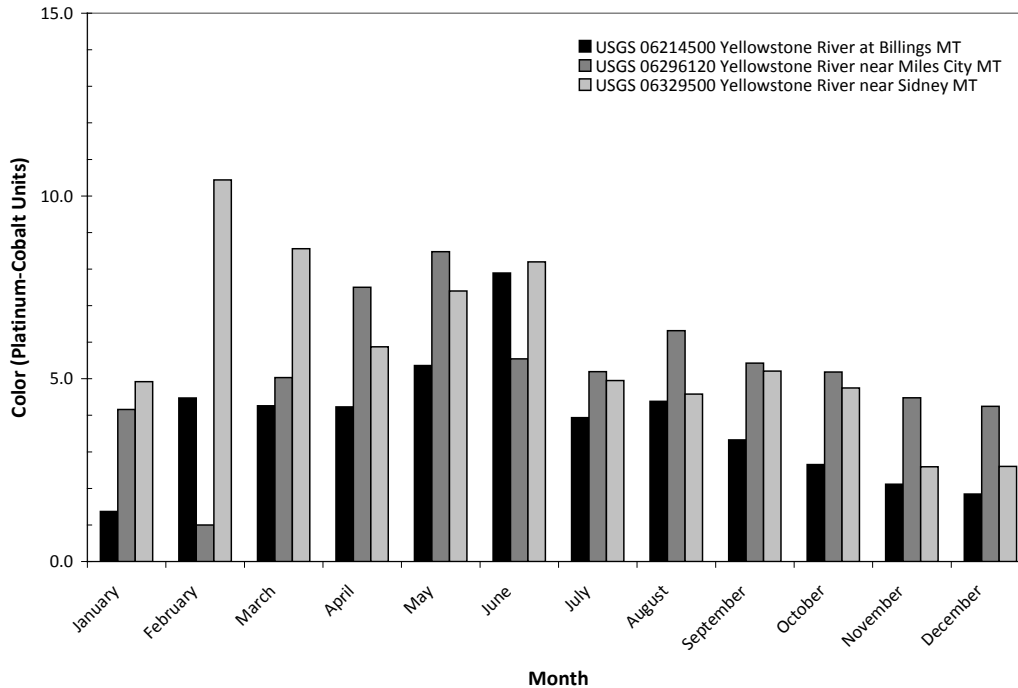
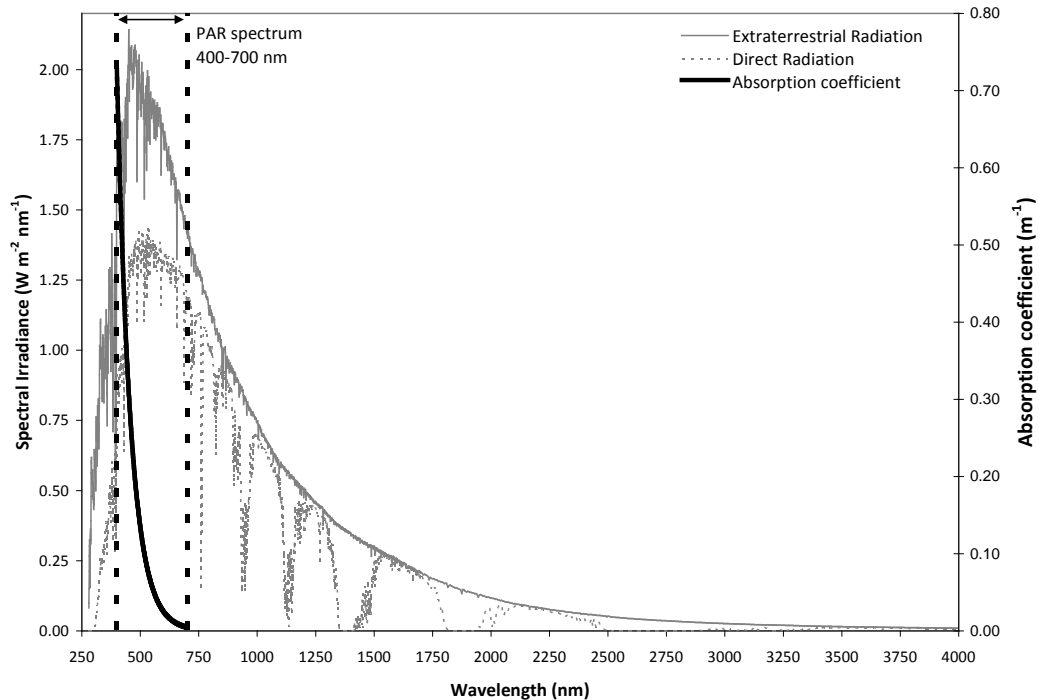

Figure 8-7. Monthly mean true color measurements for the lower Yellowstone River (1963-1970).

All months had at least 2+ observations. Observations vary from year to year however during low-flow conditions are believed to remain relatively consistent. Billings gage shown for reference only.

Given some of the uncertainty in the literature relationships, results were verified through an independent measure developed by Cuthbert and Giorgio (1992). In this method the spectrophotometric absorption coefficient at 440 nanometers (g_{440}) was obtained and related to color by the following, $g_{440} = (\text{visual color} + 0.43) / 15.53$, and was then integrated over the spectrum of 400-700 nm according to the spectral dependence of light absorbance¹ and the reference solar spectral irradiance from the American Society of Testing and Materials (ASTM) G173-03 (ASTM, 2011) (**Figure 8-8**). The irradiance weighted absorption coefficient was 0.128 m^{-1} yielding an average of the two methods of $k_{\text{eb}} = 0.121 \text{ m}^{-1}$. Thus the two methods were very similar.

¹ The spectral dependence of light absorbance is defined by the following equation (Cuthbert and Giorgio, 1992); $g_{\lambda} = g_{440} e^{-S(\lambda-440)}$, where g_{λ} =light attenuation coefficient (m^{-1}) at a specified wavelength (nm), g_{440} =the light attenuation coefficient at 440 nanometers, and the S =slope which falls in a fairly narrow range of values reported in the literature [$0.01688 \text{ (nm}^{-1})$ used].



1
2 **Figure 8-8. ASTM reference spectra used to evaluate the net absorption coefficient for color.**

3
4 The other partial attenuation coefficients were determined according to additional theoretical and
5 empirical considerations. The estimate of partial light attenuation for inorganic suspended solids (ISS)
6 was based on the relationship from Blom, et al., (1994) where α_i is roughly proportional to the fall
7 velocity (m day^{-1}) to the -0.5 power. In their work, values of 0.0064 - 0.059 ($\text{m}^2 \text{g}^{-1}$) were reported, and
8 particles with the smallest size (e.g., settling velocity) or highest organic content had the highest light
9 attenuation. Values of 0.019 - 0.137 $\text{m}^2 \text{g}^{-1}$ have been reported elsewhere (Van Duin, et al., 2001) citing
10 (Bakema, 1988; Blom, et al., 1994; Buiteveld, 1995; Di Toro, 1978).

11
12 We estimated α_i for the Yellowstone River from low flow suspended sediment fall measurements from
13 USGS (August 1 – April 30). Only five different size classes were characterized in their work and ranged
14 in size from 0.004 to 0.25 mm (from clay particle sizes to sands). Also, the USGS reports size classes, not
15 velocity measurements. Thus fall velocities were calculated using Stokes' law (**Equation 8-6**) (Chapra,
16 1997) where, v_s = settling velocity [m s^{-1}], α = Corey shape factor (assumed to be 1 in this application), g
17 = acceleration of gravity [m s^{-2}], $\rho_{s,w}$ = densities of sediment and water [kg m^{-3}] (assume silt, $2,650$), μ =
18 dynamic viscosity of water at 20°C [$\text{kg m}^{-1} \text{s}^{-1}$], and d = effective particle diameter [m].

19
20 **(Equation 8-6)**
$$v_s = \alpha \frac{g (\rho_s - \rho_w)}{18 \nu} d^2$$

21
22 From the Stokes relationship, mean fall velocity was estimated to be 0.012 m d^{-1} with a mean (D_{50})
23 sediment diameter of 0.0004 mm (**Figure 8-9**). Most of the particles in suspension in the Yellowstone
24 River are therefore quite small (clays).

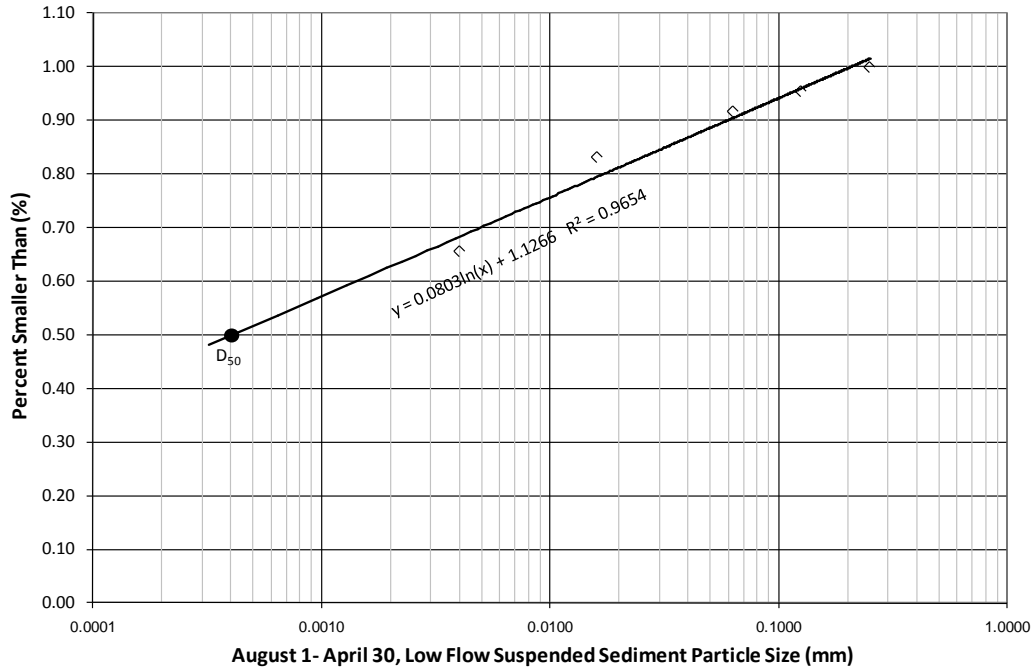

1
 2 **Figure 8-9. Suspended sediment particle size (mm) in Yellowstone River during low-flow conditions.**
 3 Data taken as average of fall diameter measurements at USGS 06295000 Yellowstone River at Forsyth MT and
 4 USGS 06329500 Yellowstone River near Sidney MT.

5
 6 Based on the computed fall velocity of 0.012 m d^{-1} , α_i from Blom, et al.,’s (1994) work was reconstructed
 7 (**Figure 8-10**) and using very simple linear regression DEQ estimated α_i to be $0.05\text{-}0.06 \text{ m}^2 \text{ g}^{-1}$ for the
 8 Yellowstone River which is near the mid to upper end of the literature (Van Duin, et al., 2001). Given
 9 that the estimate is very near the upper range of Blom, et al., (1994), and also very similar to the 0.052
 10 $\text{m}^2 \text{ g}^{-1}$ reported by Di Toro (1978), the Q2K default value was used (which happens to be from Di Toro).

11

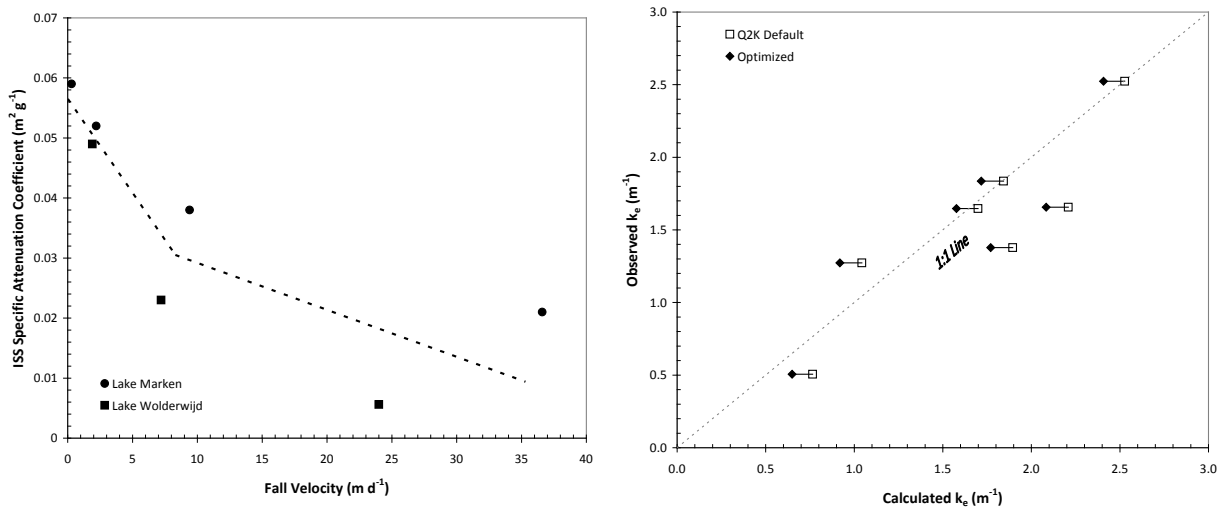

12
 13 **Figure 8-10. Optimized partial extinction coefficients for the remaining coefficients ($\alpha_i, \alpha_o, \alpha_p$ & α_{pn}).**
 14 (Left) Relationship between fall velocity and inorganic suspended solids partial attenuation coefficient ($\text{m}^2 \text{ g}^{-1}$)
 15 based on data from (Blom, et al., 1994). (Right) Optimization of remaining partial attenuation values for detritus
 16 and phytoplankton showing the relative shift toward the 1:1 line.

1 For the remaining partial attenuation coefficients (detritus¹ and phytoplankton), chemistry, PAR, and k_e
 2 data collected in 2000 were used to iterate values from their default to find the most reasonable
 3 agreement. The non-linear part of the chlorophyll equation was set to zero to be consistent with recent
 4 optics literature (Van Duin, et al., 2001). Through this process, it was established that the default
 5 recommendations in Q2K are quite good (Table 8-8) and the greatest overall improvement was from the
 6 changes in k_{eb} described previously (root mean squared error (RMSE) of 0.32 m⁻¹ to 0.27 m⁻¹). Therefore
 7 the optic coefficients in Q2K were quite good.

8
 9 **Table 8-8. Final optic coefficients for Yellowstone River Q2K model.**

10 Final/optimized values are essentially from Di Toro (Di Toro, 1978).

Suspended Material	Parameter	Units	Q2K Default	Range	Final/Optimized Value
Water & Color	k_{eb}	m ⁻¹	0.20	0.02-6.59 ¹	0.12
Inorganic Solids	α_i	m ² g ⁻¹	0.052	0.019-0.137 ²	0.052
Detritus	α_o	m ² g ⁻¹	0.174	0.008-0.174 ²	0.174
Phytoplankton	α_p	m ² g ⁻¹	0.0088	0.0088-0.031 ²	0.031
Phytoplankton	α_{pn}	m ² g ⁻¹	0.054	n/a	not used

11 ¹ Range of inland waters reported by (Kirk, 1994) at 440 nm, adjusted to irradiance from 400-700

12 ² From Van Duin et al. (2001) which includes a review of the followings studies (Bakema, 1988; Blom, et al., 1994;
 13 Buiteveld, 1995; Di Toro, 1978).

14 15 8.11 Settling Velocities

16
 17 One of the last things considered was suspended sediment settling velocities. These were detailed to
 18 some extent in **Section 8.10**, and ISS settling velocity was determined to be 0.012 m d⁻¹ (based on a D₅₀
 19 of 0.0004 mm). However, given that the river is clearly transport dominated (Hjulstrom, 1935)², it is
 20 unclear whether particulate settling would actually occur. Since turbulence tends to advect sediment
 21 both in a downward and upward direction (Whiting, et al., 2005), the calculated settling velocity of
 22 0.012 m d⁻¹ was used directly in the modeling without adjustment.

23
 24 Phytoplankton settling rates were calculated in a similar fashion by assuming dynamic equilibrium
 25 between re-suspension and deposition. The algal biovolumes detailed previously were used to
 26 determine the particle size of algae (~8 μm³)⁴ which according to Stoke's law was 0.086 m day⁻¹. This

¹ Detritus estimated from observed particulate organic carbon (POC) data (mg L⁻¹) using the SOC:VSS and AFDM:Chla ratio during 2007 (4.3 mg L⁻¹ VSS: 1 mg L⁻¹ SOC, 127 gDW:0.9 g Chla).

² Analysis of critical shear stress (τ_c) indicates that incipient motion requirements are greatly exceeded (the actual shear stress of 6.3 N m⁻² is several orders of magnitude above the τ_c of 0.005 N m⁻²).

³ Geometric mean of phytoplankton biovolumes taken (307 μm³) and particle diameter estimated using the volume of a sphere where $d = 2\sqrt[3]{\mu\text{m}^3 \frac{3}{4\pi}}$. Density of phytoplankton from (Chapra, 1997) of 1027.

⁴ Particle sizes were actually for benthic algae (not phytoplankton). However, it is believed that much of the algae in suspension are of benthic origin (Bahls, 1976b).

1 appears to be a very reasonable first estimate based on Bowie et al., (1985). Although detritus data
2 were not available, it is reasonable to believe it is a similar size as well during low flow conditions. Thus
3 0.086 m day⁻¹ was used for that as well.

4
5

1
2
3

9.0 MODEL CALIBRATION AND VALIDATION

Details regarding the model calibration and are detailed in this section. Supporting information is found in **Section 9.0**.

9.1 Approach

The approach towards calibration and validation for the Yellowstone River is shown in **Figure 8-1**. It consisted of iterative adjustment of rate coefficients until the criteria identified in **Table 8-1** were met. Validation tests were then performed to confirm whether or not the model was acceptable for use. The approach is typical of classic split sample calibration-validation methodologies where one dataset is used solely for model calibration and a second independent dataset is used for model validation¹.

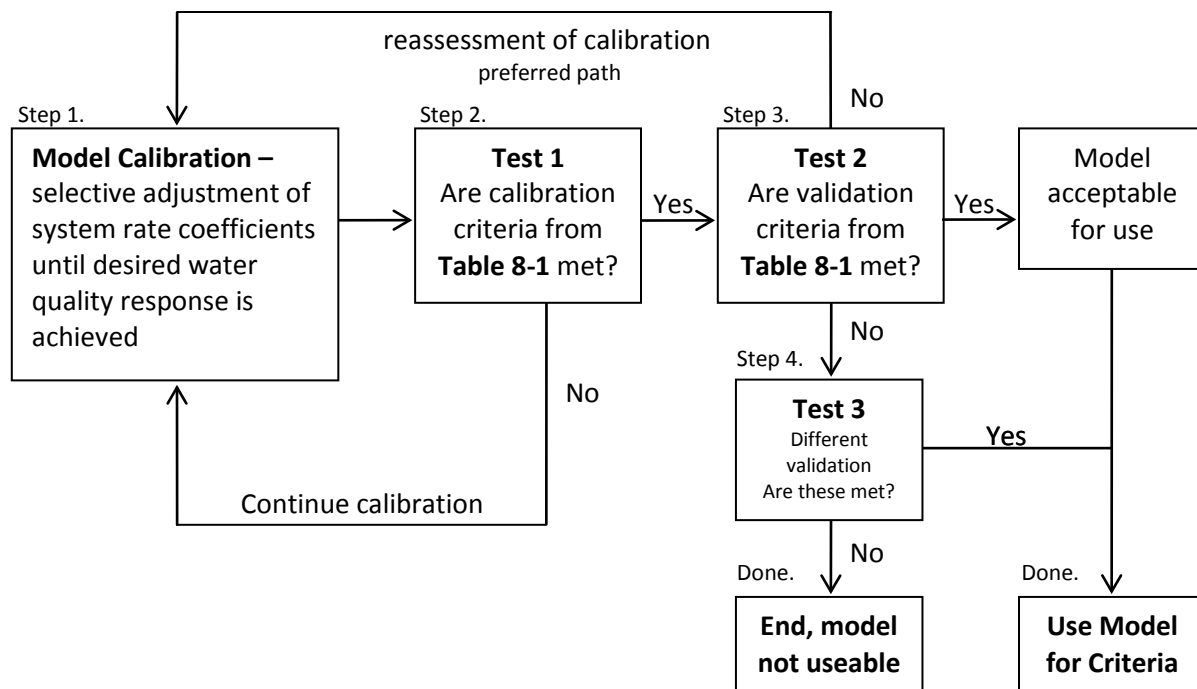

Figure 9-1. Model calibration and validation approach for the Yellowstone River.

Calibration was completed iteratively until acceptability criteria were achieved. Validation or confirmation tests were then performed to identify whether the model was acceptable for use.

¹ Two independent low flow datasets were used in model evaluation. The first was the period of August 17-26, 2007, (warm-weather) for calibration and (2) September 11-20, 2007, (cooler-weather) for validation. We also had a third independent dataset for use if necessary which was another warm weather dataset collected by USGS in August of 2000.

9.2 Calibration and Validation Time-Period

The calibration and validation periods were constrained to two 10-day periods over which the water quality sampling was completed. These were:

- **Calibration:** August 17-26, 2007
- **Validation**¹: September 11-20, 2007

Each was believed to be appropriate in minimizing streamflow and climatic variability, reducing the possibility of YSI sonde interference (i.e., from biofouling), and meeting the travel time requirements of the river. The time-frame was also similar conditions used in waste-load allocation studies (EPA, 1986b).

9.3 Evaluation Criteria for Calibration and Validation

Two statistical tests were selected to assess the sufficiency of the Yellowstone River model calibration. These include relative error (RE) and the root mean squared error (RMSE). RE is a measure of the percent difference between observed and predicted ordinates and is calculated as shown below in **Equation 9-1**, where RE = relative error, Obs_i = observed state variable, Sim_i = Simulated state variable. Overall system RE should approach 0% (on average) and QAPP and literature recommendations for specific model state-variable are shown in **Table 9-1**.

(Equation 9-1)

$$RE = \frac{(Sim_i - Obs_i)}{Obs_i}$$

Root mean squared error (RMSE) was also used which is a common objective function for water quality model calibration (Chapra, 1997; Little and Williams, 1992). It compares the difference between modeled and observed ordinates and uses the squared difference as the measure of fit. Thus a difference of 10 units between the predicted and observed value is 100 times worse than a difference of one unit. Squaring the differences also treats both overestimates and underestimates as undesirable. The root of the averaged squared differences is then taken as RMSE. Calculation of RMSE is shown in **Equation 9-2** (Diskin and Simon, 1977), where n is the number of observations being evaluated.

(Equation 9-2)

$$RMSE = \sqrt{\frac{1}{n} \sum_{i=1}^{i_n} [Obs_i - Sim_i]^2}$$

The utility of RMSE is that error is expressed in the same units as the data being evaluated. Thus by decreasing RMSE, model error is inherently reduced.

¹ The USGS data detailed previously (**Section 6.4**) was reserved for additional validation as described later in the document.

1 **Table 9-1. Recommended relative or standard errors for water quality model simulations.**

State Variable	QAPP criterion ± (%)	Literature Recommendation ± (%)
Temperature	5 (or 1°C)	5 ¹
Dissolved Oxygen	10 (or 0.5 mg L ⁻¹)	10 ¹ , ≤10 ²
Chlorophyll <i>a</i> – Phytoplankton	10	40 ¹ , 30-35 ³ , 30 ² , (0.5 µg L ⁻¹) ²
Chlorophyll <i>a</i> – Bottom Algae	20	10-28 ⁴
Nitrate	Not specified	30 ¹ , (25 µg L ⁻¹) ^{2a}
Ammonia	Not specified	50 ¹ , (5 µg L ⁻¹) ^{2a}
Dissolved orthophosphate	Not specified	40 ¹ , (2 µg L ⁻¹) ^{2a}

2 ¹Arhonditsis and Brett (2004), 153 aquatic modeling studies in lakes, oceans, estuaries, and rivers.3 ²Thomann (1982), studies on 15 different waterbodies (rivers and estuaries). ^{2a}Lake Ontario only.4 ³Håkanson (2003), coefficient of variation for River Danube (days to weeks).5 ⁴Biggs (2000c), for 3 rivers with varying algae densities (high, medium, low) and *n* = 10 replicates per location (very
6 close to cross-section *n* = 11 in the present study).

7

8 **9.4 Data for Calibration**

9

10 Data for calibration comes primarily from the field data collection program described in **Section 6.0**
11 which is summarized in **Table 9-2**.

12

13 **Table 9-2. Data used in calibration and validation of Q2K for the lower Yellowstone River.**

Data type	Measurement	Increment
Water chemistry/algae	1. EWI samples of nutrients, suspended solids, etc. 2. Benthic/suspended algae collections	Instantaneous
Diurnal water quality	1. YSI sonde deployments (DO, pH, temperature, etc.)	15-minute
Others described in Section 9.0 Algae, kinetics, sediment/benthics	1. Filamentous floating algal characterization 2. Academy of natural science taxonomic evaluations 3. C:N:P stoichiometry 4. Productivity/respiration experiments 5. Minimum cell quota estimates 6. Reaeration from sonde DO delta 7. Sediment oxygen demand measurement	n/a n/a n/a n/a n/a n/a n/a

14

15 Of primary importance were the water chemistry data which are shown in great detail in **Section 10.0**
16 and the YSI sonde data which provided diurnal information regarding water temperature, DO, pH, etc.¹
17 Since the sonde data are not described anywhere else in this document (and were condensed into single
18 point values by DEQ to form the data in **Section 10.0**), they are briefly reviewed here.¹ There was a great deal of ancillary information also used in calibration as detailed in **Section 8.0**.

1 YSI time-series were 83% complete for the calibration and 74% complete for the validation, which is
 2 more than sufficient for practical evaluation of river conditions. Procedures to identify missing or
 3 erroneous data (e.g., due to biofouling or snagged drifting filamentous algae interference) were
 4 identified in the SAP addendum (Suplee, et al., 2006a), and an example of a time-series for one of DEQ's
 5 sites is shown in **Figure 9-2**. A number of issues were identified at this and other sites¹, and standard
 6 procedures such as the average of the prior and following observation, or parallel estimation procedures
 7 with adjacent stations (Linacre, 1992) were used to synthesize or reconstruct errant data. Data was
 8 condensed into mean repeating day series as required in Q2K and formed the basis for the DO, pH,
 9 temperature, conductivity, and Chl a calibration of the river.

10

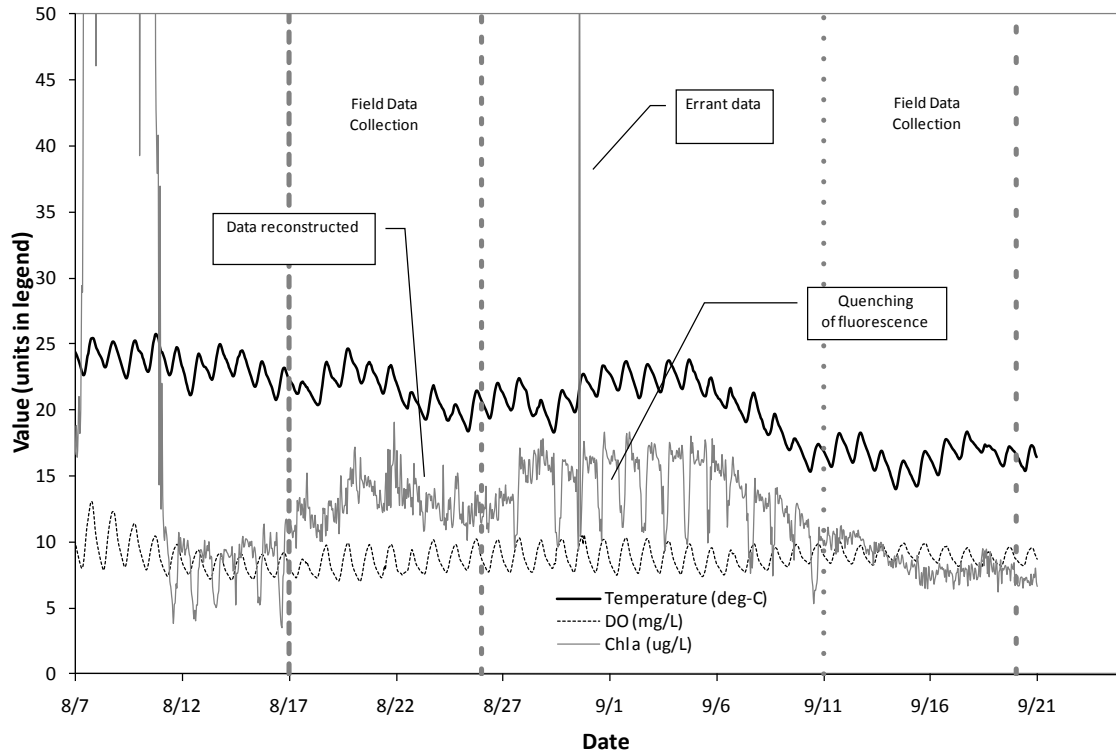

11

12

Figure 9-2. Example of YSI sonde data from the Yellowstone River in 2007.

13

Temperature, DO, and Chl a shown for YSI-20, upstream of Cartersville canal.

14

¹ Turbidity and Chl a fluorescence were most routinely affected. Spikes in turbidity (errant data as shown in the figure) or the suppression or “quenching” of chlorophyll fluorescence (also shown from approximately 8:00 a.m. to 6:00 p.m., when the sun was at its higher zeniths) were the primary problems identified. Suppression is the process whereby algae change their fluorescence when absorbed light energy exceeds their capacity for utilization (Muller, et al., 2001; Vaillancourt, 2008). It can change fluorescence by a factor of 10 with no change in Chl a concentration.

9.5 Water Chemistry Relationships with Model State-variables

Some of the information presented previously requires further explanation, in particular the relationship between water chemistry and Q2K model state-variables. These are shown in **Table 9-3** for those that are not straightforward.

Table 9-3. Relationship between Q2K state-variables water chemistry collections.

Definitions shown at the bottom of the table or are defined within the table.

Model State Variable	Symbol	Water Chemistry Relationship & Calculation [as taken from Chapra (2008)] ¹
Benthic/phytoplankton Chl <i>a</i>	a_p	Chlorophyll <i>a</i> (Chl <i>a</i>)
Detritus	m_i	TSS - VSS
Inorganic suspended solids	m_o	VSS - $r_{da} a_p$
Total suspended solids	Calculated	$m_i + m_o + r_{da} a_p$
Nitrate nitrogen	n_n	$\text{NO}_2^- + \text{NO}_3^-$ (nitrate plus nitrite)
Ammonium nitrogen	n_a	NH_4^+ - (ammonia)
Organic nitrogen	n_o	TN - $\text{NO}_2^- + \text{NO}_3^- - \text{NH}_4^+ - r_{na} a_p$
Total nitrogen	Calculated	$n_n + n_a + n_o + r_{na} a_p$
Inorganic phosphorus	p_i	SRP (soluble reactive phosphorus)
Organic phosphorus	p_o	TP - SRP - $r_{pa} a_p$
Total phosphorus	Calculated	$p_i + p_o + r_{pa} a_p$
CBOD ultimate	Calculated	$c_f + r_{oc} r_{ca} a_p + r_{oc} r_{cd} m_o$
Total organic carbon (TOC)	Calculated	DOC + POC

¹TSS = total suspended solids, VSS = volatile suspended solids, r_{da} = ratio of ash-free dry weight to phytoplankton Chl*a*, r_{na} = ratio of nitrogen to Chl*a*, r_{pa} = ratio of phosphorus to Chl*a*, c_f = fast oxidizing carbon, DOC = dissolved organic carbon, POC = particulate organic carbon, r_{oc} = ratio of oxygen to carbon, r_{oc} = ratio of carbon to Chl*a*, r_{cd} = ratio of carbon to ash-free dry weight.

9.6 Model Configuration and Solution

Model time-step, runtime, and element sizing were completed according to courant stability and critical segment sizes identified in Chapra (1997). A time step of 0.1 hours was needed to ensure stability for some of the shorter model elements, and critical element size (Δx) was balanced with dispersion and other stability requirements. The Euler and Brent solution methods were used as they are computationally efficient. During this work it was identified that steady condition boundary conditions induce oscillatory behavior in all highly advective systems at shorter element lengths. Use of correctly timed diurnal variation was found to remedy this problem, but was not efficient and we used a reduced number of elements to correct this issue (i.e., through more numerical dispersion). We also considered initial condition effects in the model in regard to benthic algal biomass [recall that initial conditions for the algae are fixed in the model ($0.1 \text{ mgChl}a \text{ m}^{-2}$) and thus require time to grow to steady state conditions]. A run time of 60-90 days was found to be necessary to ensure biomass had achieved maximum levels by the end of the simulation for existing conditions (**Figure 9-3**). A simulation length of

1 90 days was obligatory throughout the model calibration and validation to ensure that initial condition
 2 effects do not influence the final model output¹. It will be shown later that as nutrient conditions in the
 3 model increase (thus reflecting a higher growth rate), the time to achieve equilibrium biomass will
 4 decrease. Thus the run time required to reach equilibrium conditions in model development should not
 5 be confused with times to achieve nuisance biomass used in design flow specification in **Section 12.2** or
 6 in the scenarios outlined in **Section 13.0**.

7

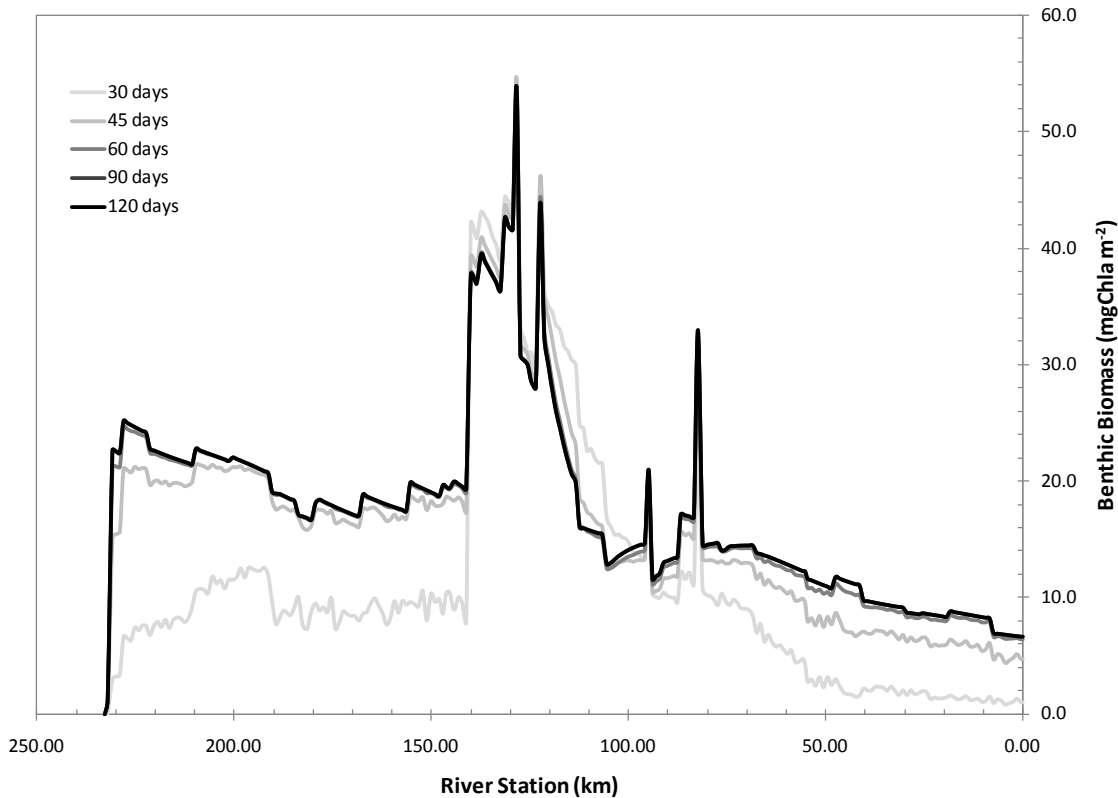

8

9 **Figure 9-3. Evaluating model runtime requirements for the Yellowstone River.**

10 Existing condition model run reflecting time required to reach steady state algal biomass. A run of approximately
 11 90 days is required to reach convergence.

12

13 9.7 Model Calibration

14

15 Two different methods were used for model calibration: manual calibration and autocalibration. Each is
 16 briefly described below.

17

¹ This computational necessity has more to do with model stability (i.e., there would rarely every be a time when the river had an initial biomass condition of as low as $0.1 \text{ mgChla m}^{-2}$) than real-world biomass growth. The only case would be following a very large annual runoff event or river spate.

9.7.1 Manual Calibration

The manual calibration relied primarily on knowledge of system coefficients and river response, field observations, past modeling experiences, and nutrient work elsewhere in Montana. Primary consideration was given toward preservation of the theoretical constructs of the model, not just curve fitting. We relied on the following indicators to complete our calibration:

- Diurnal state-variables such as temperature, dissolved oxygen and pH. These were thought to collectively encompass eutrophication and algal photosynthetic response.
- Water chemistry measurements, which are suggestive of water quality kinetics of the river including algal uptake, death and decomposition, settling, etc.
- Algal biomass measurements, which characterize algal growth rates, loss mechanisms (death, respiration, etc.), and the effect of light.
- Field rate measurements, which provide direct estimation of some of the model kinetics [e.g., sediment oxygen demand (SOD), primary productivity, etc.).
- Other indicators as described in **Section 8.0**.

Over forty rate coefficients were calibrated. General information on model calibration can be found in the literature (ASTM, 1984; Reckhow and Chapra, 1983; Thomann, 1982) therefore we do not go into explicit detail regarding the subject matter.

9.7.2 Autocalibration

A second type of calibration was also employed using a genetic algorithm. Tao (2008) developed a version of Q2K that uses shuffled-complex evolution (SCE) to optimize model parameters toward a global optimum. However, after several implementations of the automated procedure, it was found that very little improvement could be made in autocalibration over that of the initial manual calibration. Furthermore, the necessity of co-calibration with AlgaeTransect2K (AT2K) largely negated any applicability of the automated method (i.e., the two models are independent of each other and should be optimized together). Hence the autocalibration was abandoned.

9.8. Calibrated Rates for Q2K on the Yellowstone River

Calibrated rates for the Yellowstone River Q2K model along with recommended literature ranges are shown in the following pages (**Table 89-3, 89-4, 89-5, and 89-6**). They encompass much of the information detailed previously, as are supported by information in **Section 8**. Literature ranges for the calibrated values are also shown, and are taken from a compilation of studies, including 8 that were directly applicable to QUAL2E/K. For each table, a brief overview is provided for how the final calibrated values were determined. At all times, we were within the specified literature range.

1 Light and heat parameters are shown in **Table 9-4**. They were calibrated through evaluation of water
 2 temperature of the river, as noted in the table. Sediment parameters were found to be relatively
 3 insensitive and were determined from our field measurements according to bed consistency.

4

5 **Table 9-4. Light and heat parameters used in the Yellowstone River Q2K model.**

6 Based on calibration and literature review.

Parameter Description	Symbol	Units	Initial Estimate	Literature Range ¹		Final Calibrated Value
				Min	Max	
% of radiation that is PAR	n/a	dimensionless	0.47	n/a	n/a	0.47
Extinction from light/color	k_{eb}	m^{-1}	0.2	0.02	6.59	0.121 ¹
Linear Chl a light extinction	α_p	$m^{-1}(\mu gA L^{-1})$	0.031	0.009	0.031	0.031 ¹
Nonlinear Chl a extinction	α_{pn}	$m^{-1}(\mu gA L^{-1})$	not used	n/a	n/a	not used (0) ¹
ISS light extinction	α_i	$m^{-1}(mgD L^{-1})$	0.052	0.019	0.137	0.052 ¹
Detritus light extinction	α_o	$m^{-1}(mgD L^{-1})$	0.174	0.008	0.174	0.174 ¹
Atmospheric solar model	n/a	n/a	Bras	n/a	n/a	Bras ²
Bras solar parameter	n_{fac}	dimensionless	2	2	5	2.8 ²
Atmospheric emmissivity model	n/a	n/a	Brutsaert	n/a	n/a	Brutsaert ³
Wind speed function	n/a	n/a	Adams 1	n/a	n/a	Adams 2 ³
Sediment thermal thickness	H_s	cm	10	n/a	n/a	10
Sediment thermal diffusivity	α_s	$cm^2 s^{-1}$	0.0	0.002	0.012	0.009 ⁴
Sediment density	ρ_s	$g cm^{-3}$	2.2	1.5	2.7	2.1 ⁴
Water density	ρ_w	$g cm^{-3}$	1.0	1.0	1.0	1.0
Sediment heat capacity	C_{ps}	$cal g^{-1} °C^{-1}$	0.2	0.19	0.53	0.21 ⁴
Water heat capacity	C_{pw}	$cal g^{-1} °C^{-1}$	1.0	1.0	1.0	1.0

7 ¹As determined in Section 8.10 from Van Duijn et al. (2001) for optics which includes a review of the following
 8 studies (Bakema, 1988; Blom, et al., 1994; Buiteveld, 1995; Di Toro, 1978) and from Chapra et al., (2008) for
 9 sediment.

10 ²As determined in Section 7.4.

11 ³Calibrated using observed water temperature data

12 ⁴Determined from field estimates [95% gravel (rock) and 5% clay] from tables in Chapra, et al., (2008)

13

14 Calibrated rate coefficients for carbon, nitrogen, and phosphorus transformations are shown in **Table 9-**
 15 **5**. They were determined with the assistance of the information presented in **Section 8** as well as the
 16 literature review. A reference for each calibrated values is provided along with the suggested literature
 17 range identified in a number of studies.

18

19 Calibrated parameters for algae in the lower Yellowstone River are shown in **Table 9-6** for benthic algae
 20 and **Table 9-7** for phytoplankton. The kinetics between the two algal types was varied as a function of
 21 growth rate and since growth rate is a function of cell size or volume (Harris, 1986), we assumed that
 22 algae in suspension (phytoplankton) would be smaller and grow faster (therefore having lower
 23 subsistence quotas, higher uptake rates, and lower half-saturation constants) than larger (benthic) algae.
 24 In regard to our final calibrated rates, they were well with the specified literature range and do not
 25 differ greatly from past studies completed elsewhere in the state (Knudson and Swanson, 1976; Lohman
 26 and Prisco, 1992; Peterson, et al., 2001; Watson, et al., 1990).

27

28

29

1 **Table 9-5. C:N:P rate coefficients used in the Yellowstone River Q2K model.**

2 Based on calibration and literature review.

Parameter Description	Symbol	Units	Initial Estimate	Approximate Literature Range ¹		Final Calibrated Value
				Min	Max	
Stoichiometry:²						
Carbon	gC	grams	40	n/a	n/a	43
Nitrogen	gN	grams	7.2	n/a	n/a	4.7
Phosphorus	gP	grams	1	n/a	n/a	1
Dry weight	gD	grams	100	n/a	n/a	107
Chlorophyll	gA	grams	1	n/a	n/a	0.4
Carbon:						
Fast CBOD oxidation rate	k_{dcs}	d ⁻¹	0.2	0.005	5.0	0.2
Temp correction	θ_{dc}	dimensionless	1.05	1.02	1.15	1.05
Nitrogen:						
Organic N hydrolysis rate	k_{hn}	d ⁻¹	0.2	0.001	1.0	0.1 ³
Temp correction	θ_{nn}	dimensionless	1.08	1.02	1.08	1.08
Organic N settling velocity	v_{on}	m d ⁻¹	0.1	0	0.1	0 ³
Ammonium nitrification rate	k_{na}	d ⁻¹	1.0	0.01	10	2.5 ³
Temp correction	θ_{na}	dimensionless	1.08	1.07	1.10	1.08
Nitrate denitrification rate	K_{dn}	d ⁻¹	0	0.002	2.0	0.1 ³
Temp correction	θ_{dn}	dimensionless	1.05	1.02	10.9	1.05
Sediment denitrification trans.	v_{di}	m d ⁻¹	0	0	1	0
Temp correction	θ_{di}	dimensionless	1.05	n/a	n/a	1.05
Phosphorus:						
Organic P hydrolysis rate	k_{hp}	d ⁻¹	0.2	0.001	1	0.1 ³
Temp correction	θ_{hp}	dimensionless	1.05	1.02	1.09	1.05
Organic P settling velocity	v_{op}	m d ⁻¹	0.1	0	0.1	0.012 ³
SRP settling velocity	v_{ip}	m d ⁻¹	0	0	0.1	0
SRP sorption coefficient	k_{dpi}	L mgD ⁻¹	0	n/a	n/a	0
Sed P oxygen attenuation	K_{spi}	mgO ₂ L ⁻¹	20	n/a	n/a	not used (20)
Suspended Solids:						
ISS settling velocity	v_i	m d ⁻¹	0.1	0	30	0.012 ⁵
Detritus dissolution rate	k_{dt}	d ⁻¹	0.5	0.05	3	0.25
Temp correction	θ_{dt}	dimensionless	1.05	n/a	n/a	1.05
Detritus settling velocity	v_{dt}	m d ⁻¹	0.1	0	1	0.05 ⁵

3 ¹ From the following: (Bowie, et al., 1985; Chapra, 1997; Chaudhury, et al., 1998; Cushing, et al., 1993; Droic and
4 Koncan, 1999; Fang, et al., 2008; Kannel, et al., 2006; Ning, et al., 2000; Park and Lee, 2002; Turner, et al., 2009;
5 Van Orden and Uchirin, 1993);(de Jonge, 1980)

6 ²From the sestonic C:N:P analysis detailed in **Section 8.4.**

7 ³From calibration

8 ⁴From settling velocity estimates in **Section 8.11.**

9

10

11

12

1 **Table 9-6. Bottom algae Q2K parameterization for the lower Yellowstone River.**

2 Based on calibration and literature review.

Parameter Description	Symbol	Units	Initial Estimate	Approximate Literature Range ¹		Final Calibrated Value
				Min	Max	
Max growth rate	C_{gb}	mgA m ⁻² day ⁻¹	400	15	500	400 ²
Temp correction	q_{gb}	dimensionless	1.07	1.01	1.2	1.07
Respiration rate	k_{rb}	day ⁻¹	0.3	0.02	0.8	0.2 ³
Temp correction	q_{rb}	dimensionless	1.07	1.01	1.2	1.07
Excretion rate	k_{eb}	day ⁻¹	0.0	0.00	0.5	0
Temp correction	q_{db}	dimensionless	1.07	1.01	1.2	1.07
Death rate	k_{db}	day ⁻¹	0.0	0.00	0.8	0.3 ⁴
Temp correction	q_{db}	dimensionless	1.07	1.01	1.2	1.07
External N half-sat. constant	k_{sPb}	µgN L ⁻¹	350	10	750	250 ⁴
External P half-sat. constant	k_{sNb}	µgP L ⁻¹	100	5	175	125 ⁴
Inorganic C half-sat. constant	k_{sCb}	mole L ⁻¹	1.30E-05	n/a	n/a	not used (0)
Light model	n/a	n/a	Smith	n/a	n/a	Half saturation
Light constant	K_{Lb}	langley day ⁻¹	100	30	90	60 ⁴
Ammonia preference	k_{hnxb}	µgN L ⁻¹	15	5	30	20 ⁴
Subsistence quota for N	q_{ONb}	mgN mgA ⁻¹	0.7	0.5	5.0	3.20 ⁵
Subsistence quota for P	q_{OPb}	mgP mgA ⁻¹	0.1	.05	0.5	0.13 ⁵
Maximum uptake rate for N	r_{mNb}	mgN mgA ⁻¹ day ⁻¹	70	5	100	35 ⁴
Maximum uptake rate for P	r_{mPb}	mgP mgA ⁻¹ day ⁻¹	10	1	15	4 ⁴
Internal N half-sat. constant	K_{qNb}	mgN mgA ⁻¹	0.9	0.25	5.0	3.20 ⁴
Internal P half-sat. constant	K_{qPb}	mgP mgA ⁻¹	0.13	0.025	0.5	0.09 ⁴

3 ¹From the following: [(Auer and Canale, 1982b; Biggs, 1990; Borchardt, 1996; Bothwell, 1985; Bothwell, 1988;
4 Bothwell and Stockner, 1980; Bowie, et al., 1985; Chapra, 1997; Chaudhury, et al., 1998; Cushing, et al., 1993; Di
5 Toro, 1980; Drolc and Koncan, 1999; Fang, et al., 2008; Hill, 1996; Horner, et al., 1983; Kannel, et al., 2006; Klarich,
6 1977; Lohman and Priscu, 1992; Ning, et al., 2000; Park and Lee, 2002; Rutherford, et al., 2000; Shuter, 1978;
7 Stevenson, 1990; Tomlinson, et al., 2010; Turner, et al., 2009; Van Orden and Uchirin, 1993)]

8 ²From discussion in **Section 8.5**.

9 ³From light-dark bottle experiments in **Section 8.5**.

10 ⁴Calibrated

11 ⁵Initial estimate from **Section 8.6**.

12
13
14
15
16
17
18
19
20
21
22
23

1 **Table 9-7. Phytoplankton parameter Q2K parameterization for the lower Yellowstone River.**

Parameter Description	Symbol	Units	Initial Estimate	Approximate Literature Range ¹		Final Calibrated Value
				Min	Max	
Max growth rate	C_{gp}	day ⁻¹	2.5	0.5	3.0	2.3 ²
Temp correction	q_{gp}	dimensionless	1.07	1.01	1.2	1.07
Respiration rate	k_{rp}	day ⁻¹	0.3	0.02	0.8	0.2 ²
Temp correction	q_{rp}	dimensionless	1.07	1.01	1.2	1.07
Excretion rate	k_{ep}	day ⁻¹	0.0	0.00	0.5	0
Temp correction	q_{dp}	dimensionless	1.05	1.01	1.2	1.07
Death rate	k_{dp}	day ⁻¹	0.0	0.00	0.5	0.15 ³
Temp correction	q_{dp}	dimensionless	1.07	1.01	1.2	1.07
External N half-sat. constant	k_{sPp}	µgN L ⁻¹	70	5	50	40 ³
External P half-sat. constant	k_{sNp}	µgP L ⁻¹	10	10	60	12 ³
Inorganic C half-sat. constant	k_{sCp}	mole L ⁻¹	1.30E-05	n/a	n/a	0.00E+00
Light model			Smith	n/a	n/a	Half saturation
Light constant	K_{Lp}	langley day ⁻¹	100	30	90	60 ³
Ammonia preference	k_{hnxp}	µgN L ⁻¹	15	5	30	20 ³
Subsistence quota for N	q_{ONp}	mgN mgA ⁻¹	0.7	0.5	5.0	2.50 ⁴
Subsistence quota for P	q_{OPp}	mgP mgA ⁻¹	0.1	.05	0.5	0.10 ⁴
Maximum uptake rate for N	r_{mNp}	mgN mgA ⁻¹ day ⁻¹	70	5	100	40 ³
Maximum uptake rate for P	r_{mPp}	mgP mgA ⁻¹ day ⁻¹	10	1	15	27 ³
Internal N half-sat. constant	K_{qNp}	mgN mgA ⁻¹	0.9	0.25	5.0	2.50 ³
Internal P half-sat. constant	K_{qPp}	mgP mgA ⁻¹	0.13	0.025	0.5	0.05 ³
Settling velocity	v_a	m day ⁻¹	0.1	0	1	0.05 ⁵

2 ¹From the following: [(Auer and Canale, 1982b; Biggs, 1990; Borchardt, 1996; Bothwell, 1985; Bothwell, 1988;
3 Bothwell and Stockner, 1980; Bowie, et al., 1985; Chapra, 1997; Chaudhury, et al., 1998; Cushing, et al., 1993; Di
4 Toro, 1980; Drolc and Koncan, 1999; Fang, et al., 2008; Hill, 1996; Horner, et al., 1983; Kannel, et al., 2006; Klarich,
5 1977; Lohman and Priscu, 1992; Ning, et al., 2000; Park and Lee, 2002; Rutherford, et al., 2000; Shuter, 1978;
6 Stevenson, 1990; Tomlinson, et al., 2010; Turner, et al., 2009; Van Orden and Uchirin, 1993)]

7 ²From the light dark bottle experiments in **Section 8.5**

8 ³Calibrated

9 ⁴Initial estimate from **Section 8.6**.

10 ⁵From settling velocity estimates in **Section 8.11**.

11

1

10.0 REVIEW OF MODEL OUTPUT AND COMPARISON TO FIELD DATA

The results of the modeling are contained in this section. To assist readers, a statistical summary has been presented first so that quick conclusions can be made (**Table 10-1**). In all cases except for one, (i.e., benthic algae) we met our Quality Assurance Project Plan (QAPP) criteria or literature recommended acceptance criteria. This required a second validation to do so. Results follow, and a complete discussion about the use of a second validation is described in **Section 11.0**.

Table 10-1. Statistical summary of Q2K model simulations for Yellowstone River.

State-variable	August 2007 (calibration)			September 2007 (validation)			August 2000 (2 nd validation)		
	RMSE (units)	RE (%)	met	RMSE (units)	RE (%)	met	RMSE (units)	RE (%)	Met
Streamflow ($\text{m}^3 \text{s}^{-1}$)	0	0	n/a	0	0	n/a	0	0	n/a
Width (m)	26	3.6	n/a	n/a	n/a	n/a	n/a	n/a	n/a
Depth (m)	0.5	-22.2	n/a	n/a	n/a	n/a	n/a	n/a	n/a
Travel-time (days)	0.01	-0.6	n/a	n/a	n/a	n/a	n/a	n/a	n/a
Reaeration (day^{-1})	0.87	-12.4	n/a	n/a	n/a	n/a	n/a	n/a	n/a
Temperature ($^{\circ}\text{C}$)	0.24	0.0	yes	0.38	-0.7	yes	1.4	-0.2	n/a
TSS (mgD L^{-1})	3.5	9.9	n/a	9.0	-8.9	n/a	2.1	-7.0	n/a
ISS (mgD L^{-1})	2.2	3.3	n/a	9.2	-19.3	n/a	---	---	---
Detritus (mgD L^{-1})	0.9	4.1	n/a	1.5	22.0	n/a	---	---	---
Total N ($\mu\text{g L}^{-1}$)	37	7.3	n/a	67	13.8	n/a	44 ³	7.5	n/a
Organic N	22	-0.6	n/a	79	23.2	n/a			
NO ₂ +NO ₃	9	215	n/a	29	-63.2	n/a			
NH ₄	8	-36.4	n/a	17	-47.8	n/a			
Total P ($\mu\text{g L}^{-1}$)	9	-11.7	n/a	6	8.9	n/a	5	-11.7	n/a
Organic P	8	-11.5	n/a	5	11.9	n/a	---	---	---
SRP	nd	nd	n/a	nd	nd	n/a	---	---	---
Benthic Algae (mgChla m^{-2})									
Q2K	4	10.3	yes	23	86.7	*no	n/a	n/a	n/a
AT2K ¹	22	51.9	*no	24	-0.8	yes	---	---	---
Phytoplankton ² ($\mu\text{gChla L}^{-1}$)	1.9	-2.0	yes	1.1	-3.0	yes	1.8	18.5	yes
Dissolved Oxygen ($\text{mgO}_2 \text{L}^{-1}$)	0.59	-2.5	yes	0.63	0.21	yes	0.36	1.8	yes
CBOD ($\text{mgO}_2 \text{L}^{-1}$)	n/a	n/a	n/a	n/a	n/a	n/a	n/a	n/a	n/a
pH (pH units)	0.16	0.9	n/a	0.18	-1.4	n/a	0.07	-0.2	n/a
Alkalinity ($\text{mgCaCO}_3 \text{L}^{-1}$)	1.5	0.0	n/a	2.5	1.5	n/a	2.9	-0.9	n/a
TOC (mgC L^{-1})	n/a	n/a	n/a	n/a	n/a	n/a	n/a	n/a	n/a
Conductivity ($\mu\text{S cm}^{-1}$)	n/a	n/a	n/a	n/a	n/a	n/a	n/a	n/a	n/a

n/a = not applicable or not assessed.

nd = not determined (analytical data below reporting limit).

¹Using alternative growth rate.

²Based on YSI sonde data.

³With the assumptions detailed in **Section 11.3.5.1**.

10.1 Streamflow Hydrology

Simulated and observed streamflow for the August and September evaluation period is shown in **Figure 10-1**. Due to the fact that the water balance is constrained by gage observations (**Section 7.2**), no deviation occurs between simulated and observed flows (i.e., $RMSE=0\text{ m}^3\text{ s}^{-1}$ and $RE=0\%$). Simulated flows ranged from $100\text{--}135\text{ m}^3\text{ s}^{-1}$, with the primary difference being incoming flow at the headwater boundary condition and inter-reach irrigation. Flow in September is 15-30% greater than in August, which is attributed to a 15% increase in headwater flow and an equal decrease in diversion rates. Estimates fit well with an independent mass balance model based on evapotranspiration (ET) and crop water use requirements for the region¹.

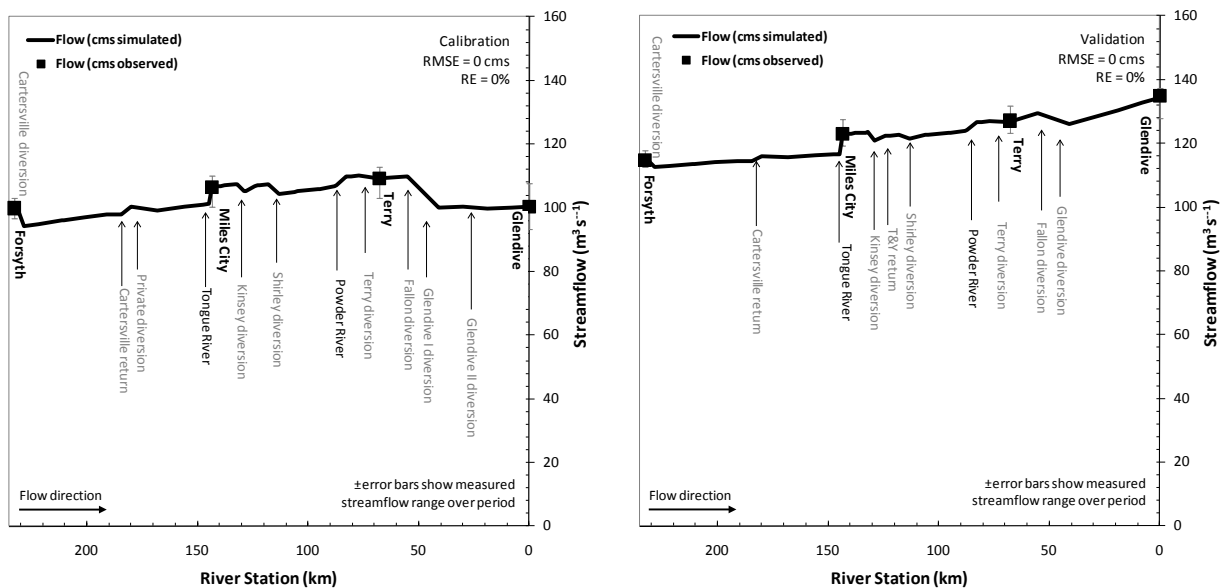

Figure 10-1. Simulated and observed streamflow for the Yellowstone River during 2007.

(Left panel) August calibration. (Right panel) September validation. Flows during August remained relatively constant due to irrigation depletion whereas in September the streamflow profile shows a longitudinal increase in flow due to reductions in irrigation pumping rates. The water balance is typical of irrigated watersheds in Montana where irrigation plays a major role in the surface water balance.

¹ The ET model was based on peak alfalfa at the Terry AgriMet site which consumed 0.6 and 0.5 cm day^{-1} (0.23 and $0.20\text{ inch day}^{-1}$) of water (August and September periods respectively). The mass balance was determined as follows: $\text{Diversion} = \text{Crop ET} + \text{Return Flow} + \text{Ditch loss}$, which for August calculations were $27.81 = 13.64 + 7.38 + 6.79$, (all in $\text{m}^3\text{ s}^{-1}$). Crop ET was based on the NLCD irrigated area, return flow was measured, and ditch loss was assumed to be 24% (Schwarz, 2002). For late September, some of the acres were not irrigated, thus, net crop ET was unknown. It was back-calculated using our diversion estimate of $15.55 = \text{Crop ET} + 7.63 + 3.73$ which resulted in crop ET of 0.25 cm day^{-1} ($0.10\text{ inches day}^{-1}$), or half of all the irrigated acres not being irrigated.

10.2 Mass Transport, Travel-time, and Reaeration

Model hydraulics (i.e., mass transport) reflect the movement of water downstream in the river. Both advection and dispersion are calculated in the model and three methods were used to evaluate the hydraulics of the Yellowstone River. These included: (1) a review of simulated river widths and depths, (2) examination of time of travel or residence time, and (3) appraisal of reaeration.

As shown in **Figure 10-2**, the model reasonably represents river widths (RMSE=26 meters and RE=3.6%) and marginally reflects depths (RMSE=0.5 meter and RE=-22.2%). However, the simulation error is somewhat misleading, as many of the field measurements were made at bridges. Bridges are believed to be slightly deeper than normal which is apparent from review of bathymetric data for the lower river [(Sadak, 2005), also shown]. Consequently, we feel the model reflects the general river character well including: (1) the deep and slow moving water upstream of the Cartersville Diversion Dam (km 232.9-231.4), (2) the shallow and wide areas of the river near Miles City (km 150-100), (3) the deepening and widening in the lower reaches near Glendive (km 50-0), and (4) several of the rapids detailed in **Section 7.4** (km 128.9, 122.9, 95.4, 82.9). In this context, we feel we have an adequate river representation in Q2K.

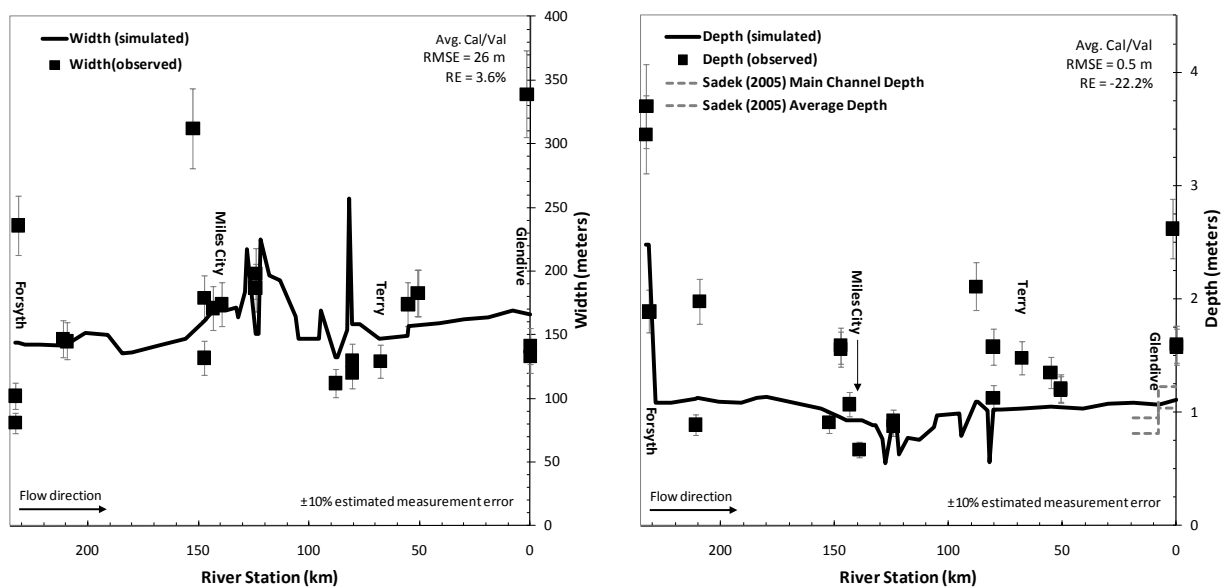
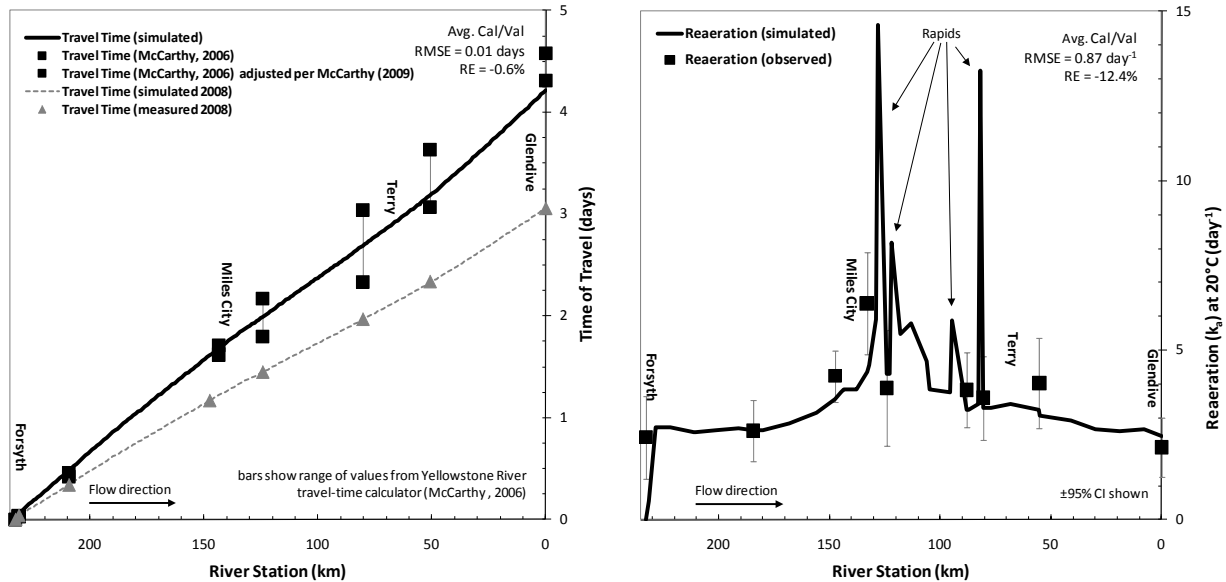

Figure 10-2. Simulated and observed river widths and depths for the Yellowstone River during 2007.

(Left panel) Simulated river width with associated error statistics. (Right panel) Same but for river depth. Comparisons shown for the average of the calibration and validation periods as very little change occurred between the two periods (i.e., approximate 4 m change in width and 0.08 m change in depth).

A more reliable estimate of mass transport is system volume and residence time. In Q2K, residence time is determined as a function of the volume and streamflow of each element. These are then summed to form the overall travel time for the river. The following data sources were used to make travel-time comparisons: (1) the travel-time calculator estimates by McCarthy (2006), (2) field-measurements from the cooperative DEQ/USGS dye tracer study in 2008 (McCarthy, 2009), and adjusted field measurements from the 2008 study. Results of the travel-time comparisons are shown in **Figure 10-3** (Left panel) and

1 are bounded by the ranges reported in the McCarthy studies¹. A separate model run for flow conditions
 2 during 2008² is also shown (i.e., during the dye tracer, but with hydraulic parameters determined from
 3 2007). RMSE was 0.01 days and RE= -0.6% for this period. A tabular comparison is shown in **Table 10-2**.
 4 For all of the different years and flow conditions, there was very little difference between simulated and
 5 observed values.
 6



7
 8 **Figure 10-3. Verification of travel-times for the Yellowstone River during 2007.**

9 (Left panel). Simulated and observed travel-time for 2007 and 2008 flow conditions. (Right panel) Simulated and
 10 observed reaeration for the Yellowstone River during 2007. It should be noted that reaeration from the Cartersville
 11 Diversion Dam is not shown in the plots. It is computed separately as a function of the height of the drop of the
 12 structure in the model. Error bars are based on the 95% confidence interval.

13
 14 Reaeration is a final plausible check on the model and is shown in **Figure 10-3** (right panel). It is
 15 computed as a function of depth and velocity in Q2K. Reaeration rates very closely approximate
 16 estimated field reaeration using the delta method (described in **Section 9.8**). As a result, the simulation
 17 appears reasonable. RMSE was 0.87 day^{-1} and RE=-12.4% and rates were higher in the wide shallow
 18 regions near Miles City (i.e., higher velocities) and lower elsewhere. The effect of the four rapids
 19 (mentioned previously) is also apparent.

¹ This includes the McCarthy (2006) travel-time calculator which was based on the ratio of flood wave velocity to most probable velocity and then adjusted dye velocities according to McCarthy (2009) field racer studies. The velocities in 2007 were slower making the travel-time estimates larger. These were as follows: Cartersville Diversion Dam = +24%, Rosebud Bridge = +8%, Keough Bridge (1902) = +5%, Kinsey Bridge = +17%, Calypso Bridge = +23%, Fallon Bridge = +15%, and Glendive Bell St. Bridge = +6%.

² The 2008 simulation was based on the 2008 flow condition which was derived from the 5 operational gages on the river (3 mainstem sites and Tongue and Powder Rivers). Other information was not available. Consequently the effort focused on ensuring flows matched the USGS gages sites.

1 **Table 10-2. Comparison of various travel-time estimates for Lower Yellowstone River.**

	2007			2008	
	McCarthy (2004)	McCarthy (2004) adjusted for dye	Modeled in Q2K ¹	McCarthy (2009)	Modeled in Q2K
Flow (m ³ s ⁻¹)	94-135	same	same	221-225	same
Travel-Time: Forsyth to Miles City (days)	1.7	1.6	1.6	1.2	1.2
Travel-Time: Forsyth to Glendive (days)	4.6	4.3	4.1	3.1	3.0

2 ¹Estimates shown as the average of the August and September simulations. These were within 0.1 days at Miles
3 City and 0.3 days at the end of the project reach (at Glendive).

5 10.3 Water Temperature

6
7 Water temperature simulations are shown in **Figure 10-4** (Top panel). They represent the cumulative
8 interaction of air, water, and sediment boundaries and their importance lies in the fact that they govern
9 all kinetic processes in the model¹. Modeled minimum, maximum, and mean temperatures show very
10 good agreement over the August and September period with RMSE and RE of 0.24 and 0.38°C and 0.0
11 and -0.7% respectively. Diurnal temperatures at the 1902 Bridge and Kinsey Bridge FAS were also quite
12 good (near ⅓ and ⅔ along the project reach) and are shown in **Figure 10-4** (bottom panel). In all cases,
13 simulated temperatures were within the criteria specified in the QAPP (±5°C) and are satisfactory to DEQ
14 for our model development purposes.

15
16 In general review, consistent trends occur in the longitudinal temperature of the river where water is
17 cooler in the upper and lower reaches of the river (from groundwater and climatic gradients) and
18 warmer near Miles City (km 150-100). The only difference between these locations was widening and
19 shallowing of the river and slight climatic variation. A change did occur during the calibration and
20 validation which was seasonally induced. The river was 5°C warmer in August than it was in September
21 due to longer daylength and warmer mean air temperature.

22
23 Changes in diurnal flux (maximum – minimum temperature) were not that different both periods as the
24 daily range was approximately 2-3°C. This consisted of a maximum around 6:00 p.m., nighttime
25 minimum shortly after daybreak (around 8:00 a.m.), and daily averages at both midday and midnight
26 (**Figure 10-4**, Bottom panel). Overall, the two profiles are very consistent short of the shift in mean daily
27 temperature.

28
29

¹ The Arrhenius equation (Chapra, et al., 2008) is used to adjust all biological and geochemical rate transformations in the Q2K model.

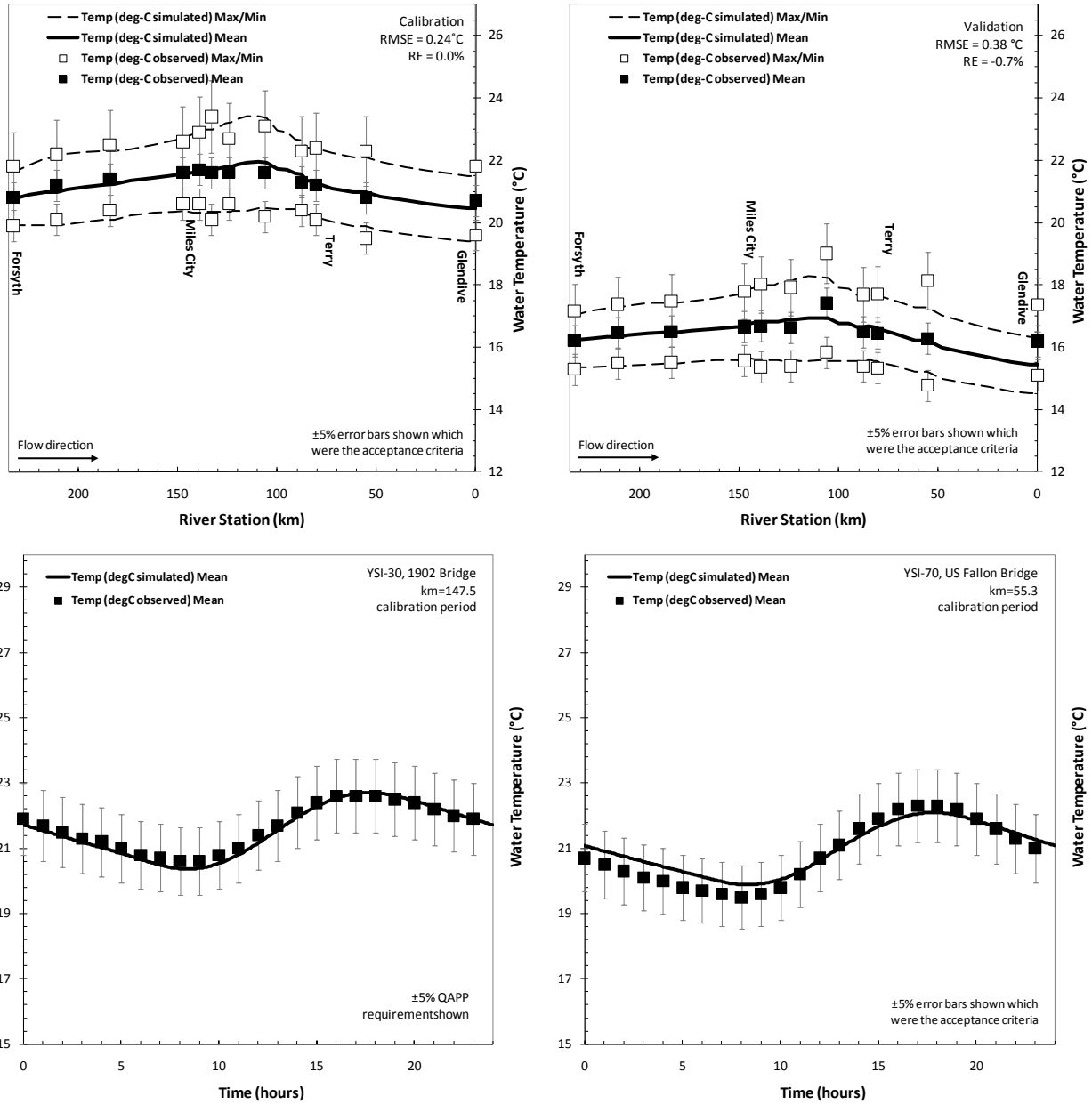

1

2

3 **Figure 10-4. Water temperature simulation for the lower Yellowstone River during 2007.**

4 (Top left/right panel) Simulated and observed water temperature for the August calibration and September
 5 validation periods. (Bottom left/right panel) Diurnal simulations for km 147.5 (1902 Bridge) and km 55.3 (upstream
 6 of O'Fallon Creek). Diurnal plots are from the calibration period.

7

8 **10.4 Water Chemistry and Diurnal Water Quality Simulations**

9

10 Water chemistry simulations represent the bulk of the work in model development and are of primary
 11 importance for the criteria development process. Output for the modeling has been grouped into
 12 functional categories so that results are more easily discussed. This includes the following:

- 1 • Suspended particles, including total suspended solids (TSS), inorganic suspended solids (ISS),
- 2 and detritus, excluding phytoplankton.
- 3 • Nutrients, both nitrogen (N) and phosphorus (P)
- 4 • Algae (both benthic algae and phytoplankton)
- 5 • Carbon [including pH, alkalinity, CBOD, and total organic carbon (TOC)]

6 Results are presented in the remaining sections¹.

7

8 **10.4.1 Suspended particles**

9

10 Suspended particles consist of both organic and inorganic materials in suspension, or collectively total
11 suspended solids (TSS). TSS increases from external loads or resuspension and is lost via settling. The
12 inorganic fraction of TSS is called ISS (inorganic suspended solids) is comprised of materials such as clays,
13 sand, and silica that are derived from inorganic materials. The organic fraction includes both living and
14 non-living material such as phytoplankton and detritus². Materials that are combustible at 550°C in a
15 muffle furnace are considered organic, while those that are not are inorganic. In the Yellowstone River, a
16 large fraction of the suspended particles were inorganic (roughly 70-80%).

17

18 Model simulations of suspended particles are shown in **Figure 10-5** [all reported as ash-free dry mass
19 (AFDM) as mg D L⁻¹. From review of the simulations, particulate matter in the model is reasonably
20 represented during both the calibration and validation period with RMSE and RE of 3.5 mg L⁻¹ and 9.9%
21 and 9.0 mg L⁻¹ and -8.9% for TSS (each period respectively) and 2.2 mg L⁻¹ and 3.3% and 9.2 mg L⁻¹ and -
22 19.3% for ISS. Hence the calibration performs better than the validation, but both are within the
23 expected uncertainty limits of the field data making it acceptable to DEQ.

24

25 In review of the simulation, there is an apparent longitudinal trend in TSS and ISS with relatively
26 consistent concentrations for the first 150 km (km 232.9-80) and then noticeable increases thereafter.
27 Much of this is coincident with the Powder River, but is not directly ascribed to it as its load was minimal
28 at the time of monitoring. Similarly, the increase could not be linked to other inflows either (e.g., other
29 tributaries, irrigation return flows). Consequently, this indicates that large contributions of suspended
30 sediment were coming directly from the Yellowstone River (autochthonous). This is most likely
31 deposited material from previous high flow events from the Powder River that was being resuspended

¹ Throughout the rest of the discussion attempts are made to characterize measurement uncertainty of our observed data. This is not meant to take away from, or add to, the apparent reliability of the model. Rather, it is to show potential ranges for the purpose of assessing model usability. These were taken directly from our monitoring instrumentation, or from Harmel, et al., (2006) as described in **Section 7.7**. Their typical collection scenario average error was used. More robust methods to address model uncertainty are detailed in later sections.

² Detritus consists of dead and decaying (non-living) organic matter. It can be lost from dissolution and increase from algal death. To separate detritus from phytoplankton mass in OSS measurements, the corrections detailed in **Section 9.4** were used.

1 from shear velocities in the Yellowstone River. Approximately 130 metric tonnes day⁻¹ of ISS were
 2 needed to balance this load. A line accretion was added to the model to reflect this increase¹.
 3

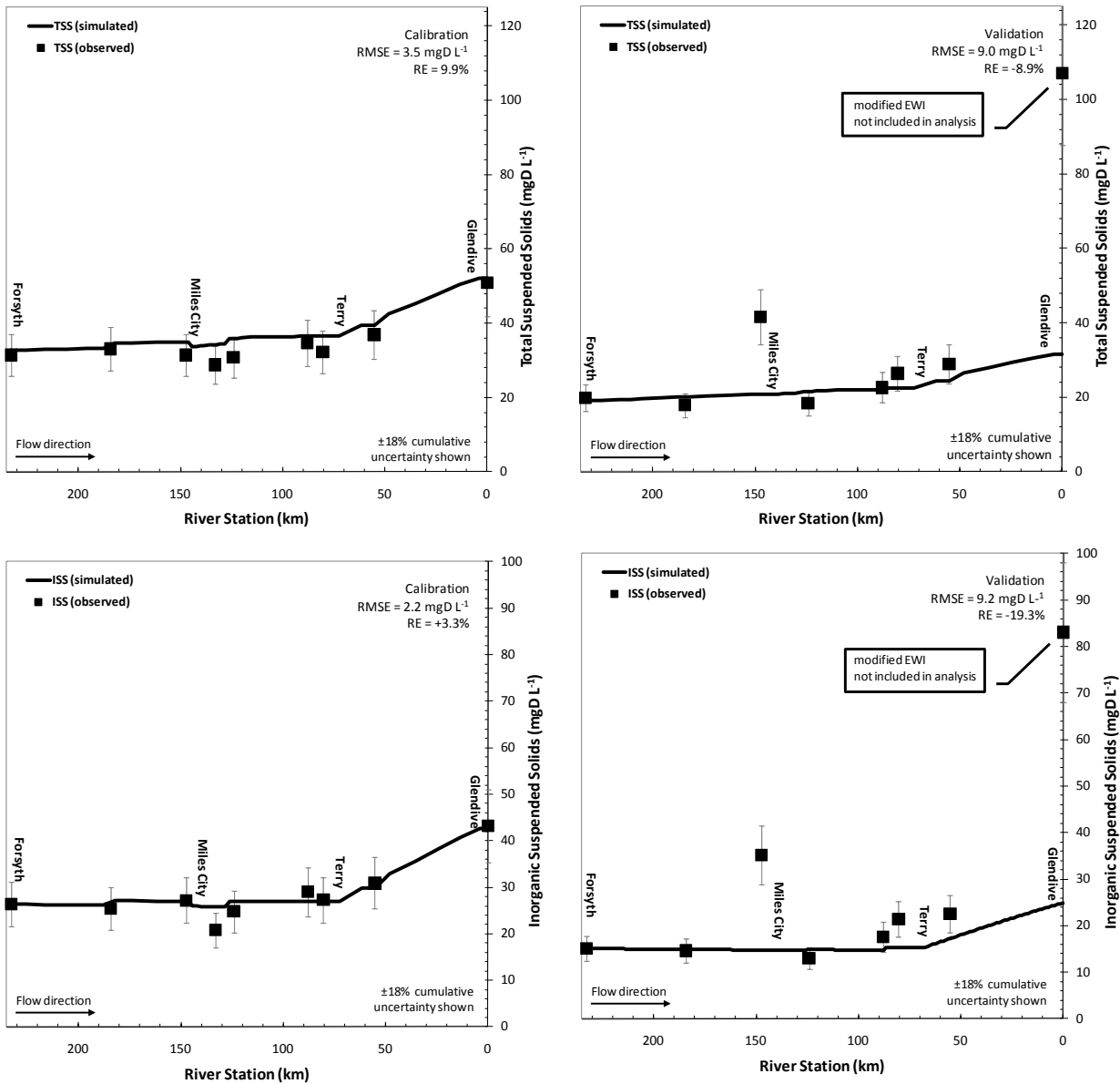

5
 6
 7 **Figure 10-5. TSS and ISS simulations for the lower Yellowstone River during 2007.**
 8 (Top left/right panel) Simulated and observed TSS values for the August and September calibration and validation
 9 period. (Bottom left/right panel) Same but for ISS. The ±18% cumulative uncertainty is based on Harmel, et al.,
 10 (2006).

¹ The Powder River actually enters at river km 87.3. However, to be consistent with the water balance (which was completed to the Terry gage), the diffuse accretion term was predicated on gage location.

1 Detritus is another suspended component and follows a pattern different than TSS/ISS. For example, it
 2 increased greatly in the first 150 km due to greater algal biomass and death whereas it declined in the
 3 lower reaches due to settling and reductions in productivity (**Figure 9-6**). RMSE and RE for detritus were
 4 0.9 and 1.5 mg L⁻¹ and 4.1 and 22% for calibration and validation, which are within the uncertainty limits.
 5

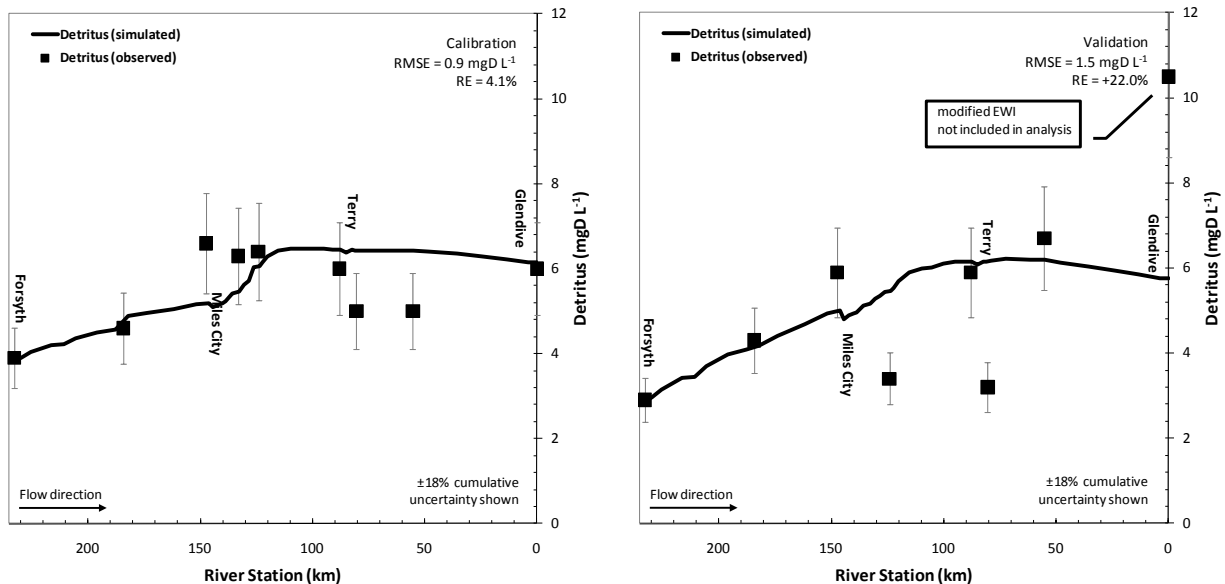

6
 7 **Figure 10-6. Detritus simulation for the lower Yellowstone River during 2007.**

8 (Left panel) Simulated and observed detrital values for the August calibration period. (Right panel) Same but for
 9 the validation. The $\pm 18\%$ cumulative uncertainty is from Harmel, et al., (2006) values for TSS.

11 10.4.2 Nutrients

12 The nutrient results, both nitrogen and phosphorus, are included in this section.

15 10.4.2.1 Nitrogen

16 All forms of nitrogen are reflected in the total nitrogen (TN) measurement which includes soluble N
 17 ($\text{NO}_2^- + \text{NO}_3^-$, NH_4^+), organic N (OrgN), and intracellular N in phytoplankton. All forms are sequentially
 18 linked through death \rightarrow hydrolysis \rightarrow nitrification \rightarrow denitrification reactions. NO_2^- is not modeled. TN
 19 and OrgN increase due to plant death and excretion and are lost from hydrolysis and settling. OrgN
 20 hydrolysis produces ammonia N (NH_4^+) which is lost to nitrification (increases NO_3^-), and both NO_3^- and
 21 NH_4^+ are lost in plant uptake, while NO_3^- can also decrease due to denitrification.

22
 23 TN and OrgN simulations are shown in **Figure 10-7**. Ambient values range from 400-500 $\mu\text{g L}^{-1}$ and
 24 generally decrease in the downstream direction. OrgN was roughly 75% of the total (i.e., 300-400 $\mu\text{g L}^{-1}$)
 25 and RMSE and RE for the calibration and validation for each constituent were 37 and 67 $\mu\text{g L}^{-1}$ and 7.3
 26 and 13.8% and 22 and 79 $\mu\text{g L}^{-1}$ and 0.6 and 23.2% for the calibration and validation respectively. TN was
 27 lowest in the middle reaches (near km 150) due to low soluble nutrients, while OrgN was highest at this
 28 same location (due to higher biomasses, productivity, and algal death). Our simulations were very close
 29 to the suggested measurement error in Harmel, et al., (2006) and TN showed a small disparity in the
 30 downstream direction. This is attributed to inflation of internal N in phytoplankton and is believed to
 31 occur at least partially because of the uncertainty in the soluble N load contributions from irrigation
 32

1 waste-drains (meaning we could have overestimated these values beyond what actually existed in the
 2 river). Case in point, the model actually performed better without them¹.

3

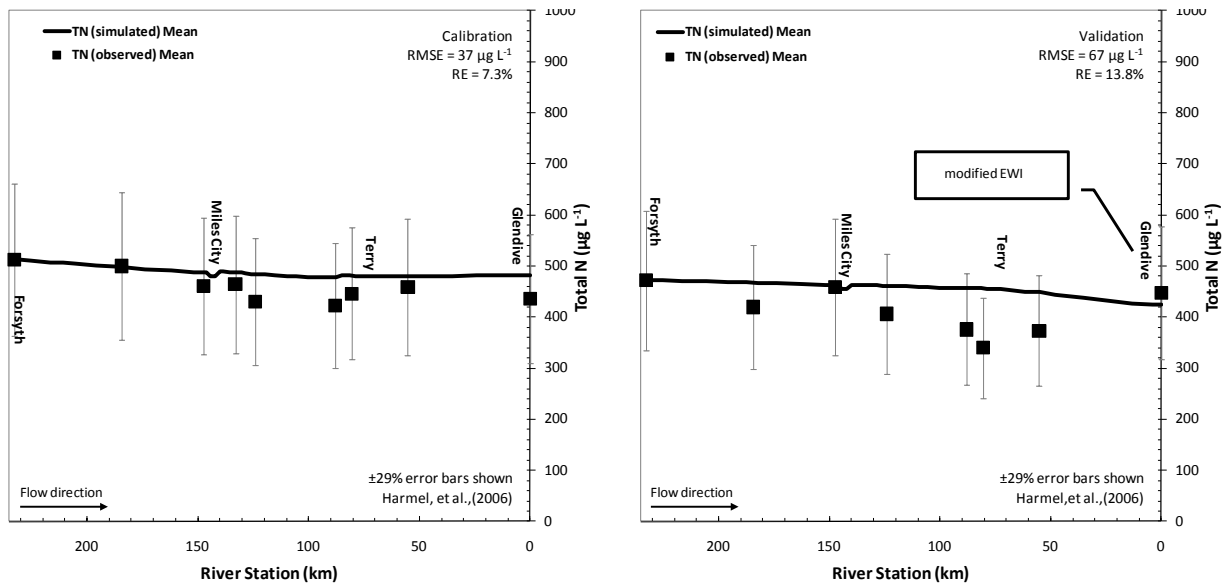

4

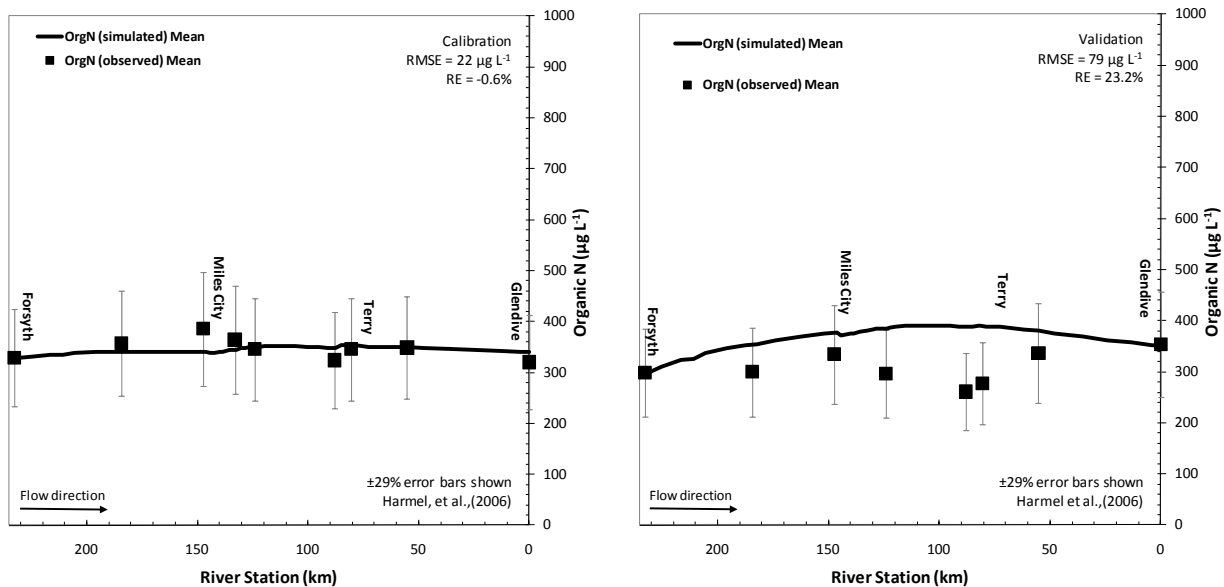

5

6 **Figure 10-7. Total and organic N simulations for the Yellowstone River during 2007.**

7 (Top left/right panel). Simulated TN for the August and September 2007 calibration and validation periods.
 8 (Bottom left/right panel). Same but for OrgN. The system appears to perhaps behave differently than the model
 9 suggests during the validation period.

10

¹ Estimated waste-drain loads were calculated as identified in **Section 7** but were calibrated down from our original estimates (they seemed to increase the nutrient load beyond expected levels).

1 From review of the TN and OrgN simulation, it appears as if there is difficulty in model validation. This is
2 evidenced by greater RMSE and RE, as well as the visual departure of the model from observed values. It
3 will be shown later that this is related to a shift in river trophic condition, which becomes a recurring
4 theme throughout the remaining discussion. The reasons for this change will be expounded upon more
5 in **Section 11.0**.

6
7 Dissolved forms of nitrogen are shown in **Figure 10-8**. Nitrate (actually $\text{NO}_2^- + \text{NO}_3^-$) showed reasonable
8 agreement although much better in the calibration than the validation. RMSE's for NO_3^- were 9 and 29
9 $\mu\text{g L}^{-1}$ (calibration and validation respectively), and relative errors were 215 and -63.2%. The magnitude
10 of the RE is misleading due to the low concentrations in the river (e.g., RMSE was only $9 \mu\text{g L}^{-1}$). Nitrate
11 uptake is very rapid and high concentrations near the upper study limit were depleted to non-detect
12 levels near the midpoint of the reach (km 150). Ammonia concentrations were quite low in 2007 (non-
13 detect to $20 \mu\text{g L}^{-1}$) as well and were characterized by a slight decline in the most productive reaches of
14 the river near Miles City (km 150) and higher concentrations elsewhere. RMSE and RE for NH_4^+ were 8
15 and $17 \mu\text{g L}^{-1}$ and -36.4 and -47.8% for the calibration and validation. These were reasonable given the
16 low concentrations.

17
18 Again, there were problems with the validation. Primarily, this was related to overestimation of soluble
19 N uptake which slowed greatly between August and September (as suggested by the change in NO_3^-
20 longitudinal curve¹). Since uptake is biologically driven, we completed experimental perturbation of
21 model rate coefficients to characterize this change and found that it was attributed to a change in
22 benthic algae rather than other model rates (i.e., all others remained consistent during the two periods).
23 A reduction in growth rate of 50% was necessary to pattern the change in uptake and other diurnal
24 indicators such as DO and pH (as described in subsequent sections).

25
26 Given the underlying difficulty, an alternative parameter set was proposed for validation which reflects
27 the change in growth rate. Mechanisms could be attributed to a number of things including physical
28 changes in the growth rate due to changes in river taxa, changes in algal light use efficiency, or changes
29 in growth rate with temperature outside that described by Arrhenius. We have chosen to show this as a
30 separate model run entitled "alternative growth rate" in all subsequent plots. Please note that this has
31 not been done to alter the validation statistics, but to better illustrate an understanding of relational
32 processes in the model. We address and elaborate on this validation deficiency in later sections.

¹ The model simulation actually showed an increase in N uptake in September which was a function of more light (i.e., less turbidity). This was slightly offset by the differences in water temperature 21°C in August compared to 16°C in September).

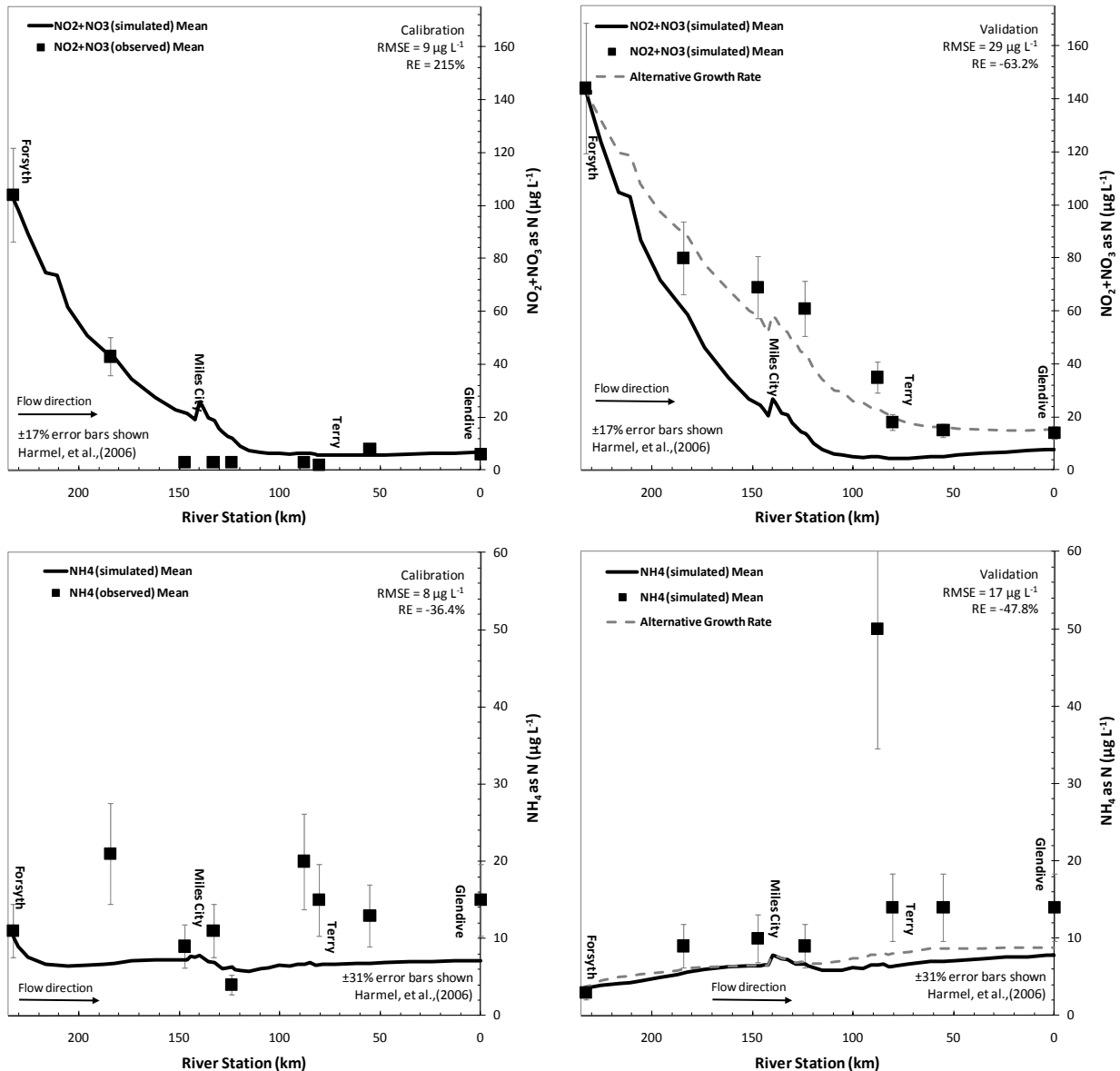

Figure 10-8. Dissolved nitrogen simulations for the Yellowstone River during 2007.

(Top left/right panel) Nitrate simulations for the August calibration and September period. (Bottom left/right panel) Same but for ammonium. The alternative growth rate illustrates the change in benthic algal growth rate to bring the model into agreement with the observed data.

10.4.2.2 Phosphorus

Similar to TN, TP represents all P in the system including organic and inorganic forms. Organic P (OrgP) increases due to plant death and excretion, and is lost via hydrolysis and settling. Inorganic P (SRP) increases from OrgP hydrolysis and excretion, and is lost through plant uptake. For the purpose of our work, SRP is considered 100% bioavailable. This assumption seems reasonable, but has been questioned by some (Li and Brett, unpublished 2011).

1 Simulations of TP and OrgP for 2007 are shown in **Figure 10-9**. Overall there is and have fairly good
 2 agreement as RMSE for the calibration and validation were 9 and 6 $\mu\text{g L}^{-1}$ and 8 and 5 $\mu\text{g L}^{-1}$ for TP and
 3 OrgP respectively, while RE was -11.7 and 8.9% and -11.5 and 11.9%. A majority of the TP was in organic
 4 form ($\sim 70\%$) and was closely related to ISS ($r^2=0.82$). A large shift in both TP and OrgP occurred
 5 downstream of the Powder River (km 90) which is related to the concomitant increase in ISS. We used
 6 the TSS-TP relationship presented by Miller, et al., (2004) to estimate this increase in the model.
 7

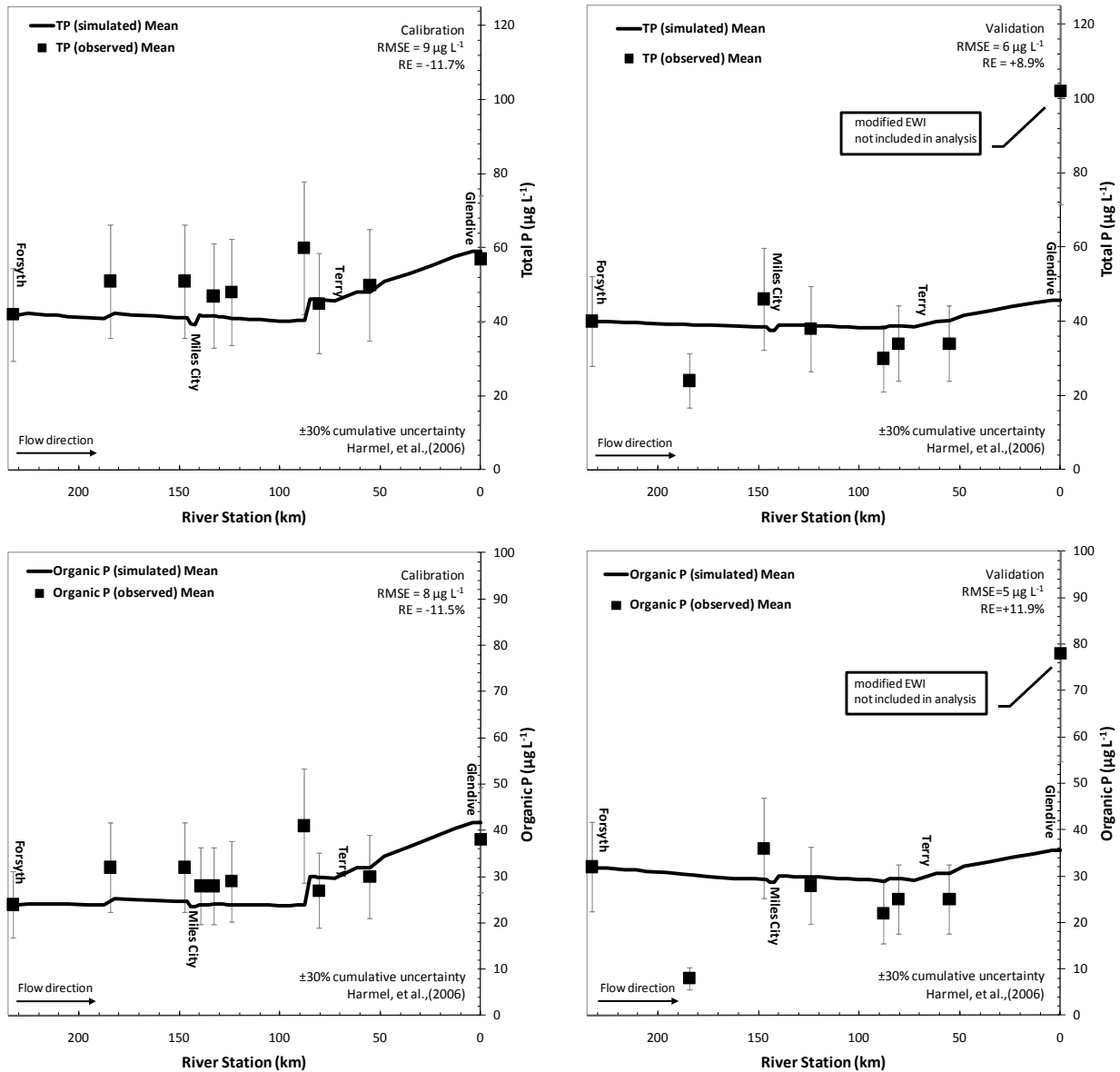

8
 9 **Figure 10-9. Total and organic phosphorus simulations for the Yellowstone River during 2007.**

10 (Top left/right panel) Simulated TP for the August and September 2007 calibration and validation periods. (Bottom
 11 left/right panel) Same but for OrgP. The problems shown in previous validation plots (i.e., for nitrogen) are less
 12 apparent for P due to N:P stoichiometric ratios.
 13

14 Soluble reactive phosphorus (SRP) comparisons were also available but should only be anecdotally
 15 considered as values were below the laboratory reporting limit of 4 $\mu\text{g L}^{-1}$. Comparisons are made with
 16

1 estimated values (flagged by DEQ, not in STORET) which ranged from 2.6-3.6 $\mu\text{g L}^{-1}$. All were near the
 2 threshold of analytical noise (i.e., the actual method detection limit) and were also affected by poor
 3 laboratory QA blanks (false detections of 2.1 $\mu\text{g L}^{-1}$, standard deviation of 0.3 $\mu\text{g L}^{-1}$, n=3). Consequently,
 4 there is some uncertainty in these data. However, we still used the SRP information to calibrate the
 5 model (only after due consideration). Simulations are shown in **Figure 10-10** and primary drivers of SRP
 6 on the Yellowstone River were found to be the Forsyth and Miles City WWTP (as evidenced by the slight
 7 increase at each location). Statistical model efficiencies were not determined due to the reasons
 8 mentioned previously.
 9

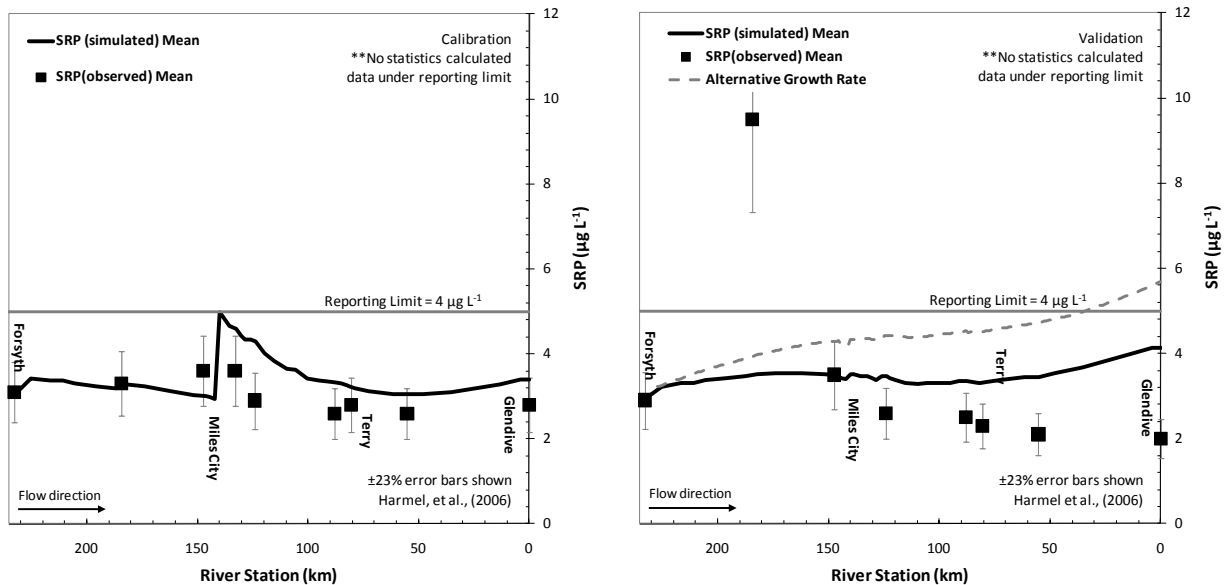

10
11

12 **Figure 10-10. Soluble phosphorus simulations for the Yellowstone River during 2007.**

13 (Left panel) Simulated SRP for the August calibration period. (Right panel) Same but for the September validation.
 14 Very little SRP was discharged by Miles City in September of 2007. No statistics were computed for SRP given the
 15 concerns described previously.
 16

17 10.4.2.3 Nutrient Limitation During 2007

18

19 Nutrient limitation can be calculated according to Droop (1973) (**Equation 10-1**) for both the N and P
 20 simulations where ϕ_N is the nutrient limitation factor, and q_{oN} , q_{oP} , q_N , and q_P are the subsistence
 21 quotas and cell quotas for nitrogen and phosphorus respectively.
 22

23 **(Equation 10-1)**
$$\phi_N = \min \left[1 - \frac{q_{oN}}{q_N}, 1 - \frac{q_{oP}}{q_P} \right]$$

24

25 Limitation is determined according to a single limiting nutrient (Liebig's law of the minimum), where the
 26 most limiting nutrient in supply attenuates algal growth. The growth attenuation factor ranges from 0-1
 27 and is multiplied by the maximum unlimited growth rate to yield the net specific growth rate. A nutrient
 28 limitation factor of 0 would be indicative of no growth, while a factor of 1 would yield maximum growth.
 29

1 Using such an approach, limitation during 2007 varies along the longitudinal extent of the river and
 2 differs between benthic algae and phytoplankton (**Figure 10-11**). In the case of benthic algae, P-
 3 limitation occurs over approximately half of the study reach (km 232.9-150) until a switch to N-limitation
 4 occurs near Miles City (from P WWTP additions). The river then ultimately goes on to co-limitation in the
 5 lower reaches. The mechanics near Miles City are the most complicated and probably are the least
 6 understood by DEQ. Phytoplankton differ in that their internal nutrient pools are more stable and are
 7 not tied to site-specific nutrient conditions (because they advect through the water column and
 8 experience longitudinal variation in nutrient conditions). In 2007, phytoplankton were N-limited
 9 (according to our seston stoichiometry measurements detailed previously, e.g., 4.7:1 N to P mass ratio)
 10 and stayed that way throughout the project reach. A slight shift occurred near the upper end of the
 11 study reach from the high soluble N (NO_3^-) levels, but in general, phytoplankton were unresponsive to
 12 site-specific environmental conditions and more responsive to the overall trend of N or P in the river.
 13

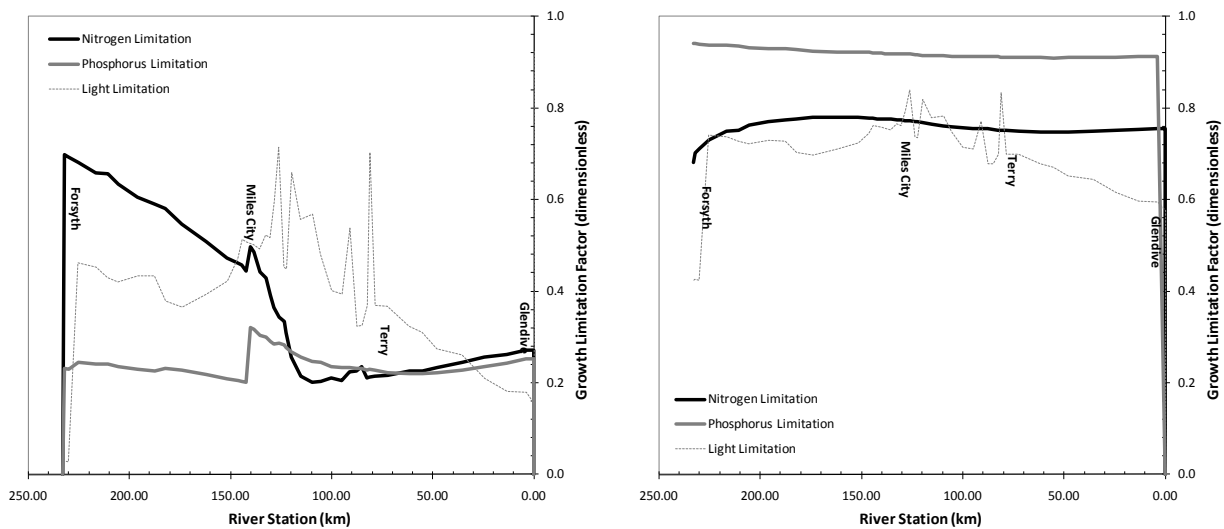

14
15

16 **Figure 10-11. Nutrient and light limitation factors for the Yellowstone River during 2007.**

17 (Left panel) Benthic algae nutrient and light limitation factors for the Yellowstone River. (Right panel) Same but for
 18 phytoplankton. The factor lowest on the y axis at any point along the x is the limiting factor. Benthic algae are P-
 19 limited from Forsyth to just downstream of Miles City (km 125) and then switch to N limitation for a short period.
 20 The river is then essentially co-limited thereafter. This is consistent with Charles and Christie (2011) who indicate a
 21 high percentage of N-fixing diatoms occur at km 125. Phytoplankton enter the reach in N-limitation and stay that
 22 way throughout. Light limitation is also shown (discussed in subsequent sections). Bottom algae are least light
 23 limited near Miles City (km 150) and are strongly light limited in the lower river. There is a consistent decline in
 24 available surface light throughout the river. This effect is less important to phytoplankton as they are able to re-
 25 circulate through the water column.

26

27 10.4.3 Algae

28

29 10.4.3.1 Benthic algae

30

31 Benthic algae are of primary importance in the Yellowstone River as shown in our sensitivity analysis and
 32 from the DO and benthic biomass relationships presented in Charles and Christie (2011). Consequently,
 33 we did considerable work understanding their importance. To characterize the lateral distribution of
 34 algae in the river, we collected 11 discrete samples at each river transect in both the wadeable and non-

1 wadeable regions. We then reduced these data into a single cross-sectional biomass average¹. For AT2K
2 analysis, the original discrete data were used.

3
4 Collections were also made to identify benthic algal taxa using standard DEQ protocols. In brief: at each
5 point, after having collected a benthic Chl a sample, we scraped/scrubbed material from the same river
6 substrate and composited it with similar material from the remaining transect points. The composite
7 sample was preserved with formalin and later analyzed for soft-bodied and diatom algae species
8 including density and taxa identification (DEQ, 2011a).

9
10 Benthic algae in Q2K increases due to photosynthesis and are lost due to respiration and death. Model
11 simulations of algal biomass [mg Chl a m⁻²] for the August and September calibration and validation
12 periods are shown in **Figure 10-12**. RMSE was 4 and 23 mg m⁻², and RE 10.3 and 86.7% each period
13 respectively. Again there were problems with the validation. Consequently, we met our QAPP criteria of
14 $\pm 20\%$ for the calibration (not for the validation), but only when hydraulic depth in the model was
15 adjusted to the exact depth of the field transect². This illustrates the importance of depth on site specific
16 algal measurements and is just one of the many difficulties that one could encounter when modeling
17 benthic algae in large rivers.

18
19 The most productive region of the river was identified to be near Miles City (km 150) where the river is
20 wide and shallow and nutrient replete due to soluble nutrient additions from the Miles City WWTP. Algal
21 biomass in the upper study reach was higher than the lower river primarily because of differences in
22 light. This translated into a light-induced shift in algal dominance from benthic alga to phytoplankton as
23 evidenced by the continued downstream decline of bottom biomasses (see **Figure 10-11** for further
24 support of this statement). It should also be noted that a number of elevated algal peaks occur at rapids
25 (e.g., shallow and wide). It is unclear if such biomasses would actually occur in these locations as they
26 would be limited by high velocities. They were included regardless of the case.

27

¹ Areal weighting procedures were used to determine equivalent cross-sectional average. In other words, the 11 biomass measurements were averaged based on equivalent area between measurements to provide a mean cross-sectional average.

² In Q2K, depth is modeled as the mean over an entire reach to meet the expected productivity response for that segment (e.g., DO, pH, etc.). However, our periphyton measurements reflect an actual site measurement (and depth), which may vary greatly from the overall average. For example, at station 150 km, hydraulic depth in the model was 0.96 vs. 1.56 meters in the field (0.6 meter difference). A similar case was noted at Pirogue Island (km 135) and O'Fallon Bridge (km 55). Thus to make a representative comparison of biomass, depth was adjusted as shown in the plots.

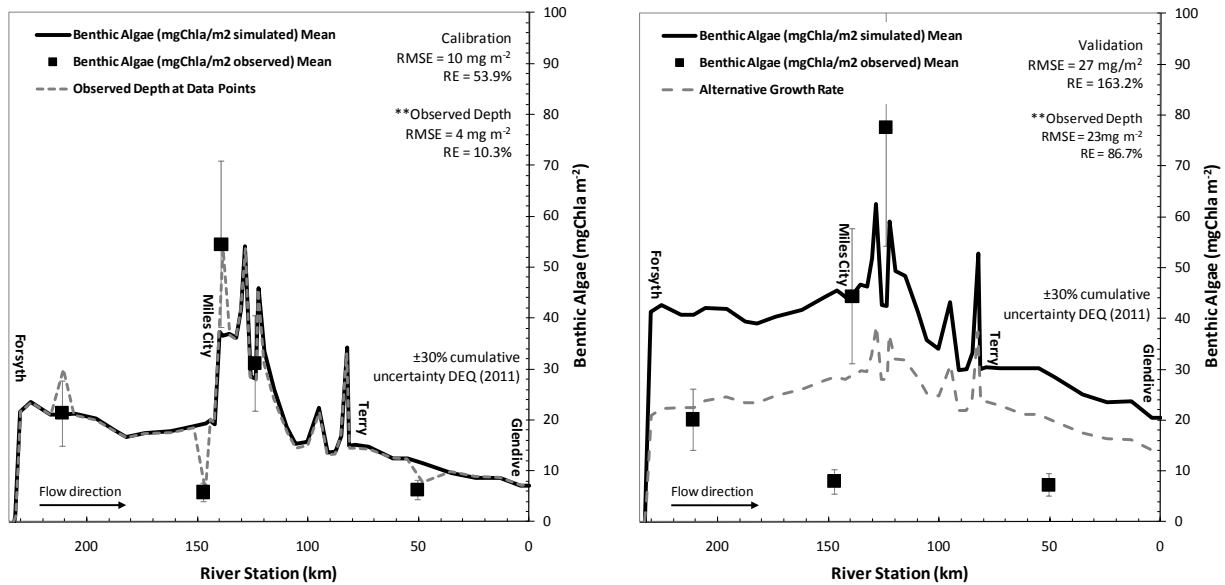

1
2 **Figure 10-12. Simulated benthic algae Chla for the Yellowstone River during 2007.**

3 (Left panel) Simulated and observed benthic algae Chla for the August 2007 calibration period. (Right panel) Same
4 but for the September 2007 validation.

5
6 As mentioned previously, the validation was problematic and algal biomasses were overestimated. This
7 suggests an overall decline in river trophicity between August and September 2007. The use of the
8 alternative growth rate improved the simulation slightly. However, over-simulations were still higher
9 than desired. As a result, we believe that the biomasses during September were more a function of
10 residual growth in August than as a result of the river's biogeochemical conditions in September.
11 Perhaps senescence had begun or a shift in algal taxa occurred. Further discussion regarding each
12 hypothesis is provided in **Section 11.1**.

14 **10.4.3.2 Benthic algae – Lateral Simulation**

15
16 The lateral distribution of algae was also evaluated using AT2K. AT2K functionally represents the same
17 light and nutrient processes as Q2K, with the exception that algal growth is evaluated laterally as
18 opposed to longitudinally. Simulations were carried out using the observed water quality data from each
19 site¹ and ATK was calibrated in a joint fashion with Q2K. Similar to the longitudinal discussion, modeled
20 lateral benthic algae distributions were relatively good for the calibration and poor for the validation
21 (**Figure 10-13**). The average RMSE and RE (across the 5 cross-sections) were 22 and 35 mg Chla m⁻² and
22 51.9% and 98.4% respectively each period. Individual cross-section RMSE ranged from 8 to 48 mg Chla
23 m⁻² and RE from -41.9 to 189%. By using the alternative growth rate (as detailed previously), the model
24 yielded slightly better results. RMSE was 24 mg Chla m⁻² and RE -0.8%. Algal biomasses were still over-

¹ This was done so that representative water chemistry/optics were applied to each transect. Also, one site location (Far West FAS) did not have any water quality data. In this instance we used simulated values from Q2K. In all locations, simulated diurnal water temperatures were used.

1 predicted, but captured the underlying trend of variation with respect to depth. Near-shore regions had
 2 highest biomasses (50-100 mg Chla m⁻²) while deeper areas (e.g., 1-2.5 meters) contributed very little
 3 (typically less than 10 mg Chla m⁻²). Hence, we can conclude that the shallow regions of large rivers are
 4 of primary importance in eutrophication management.

5

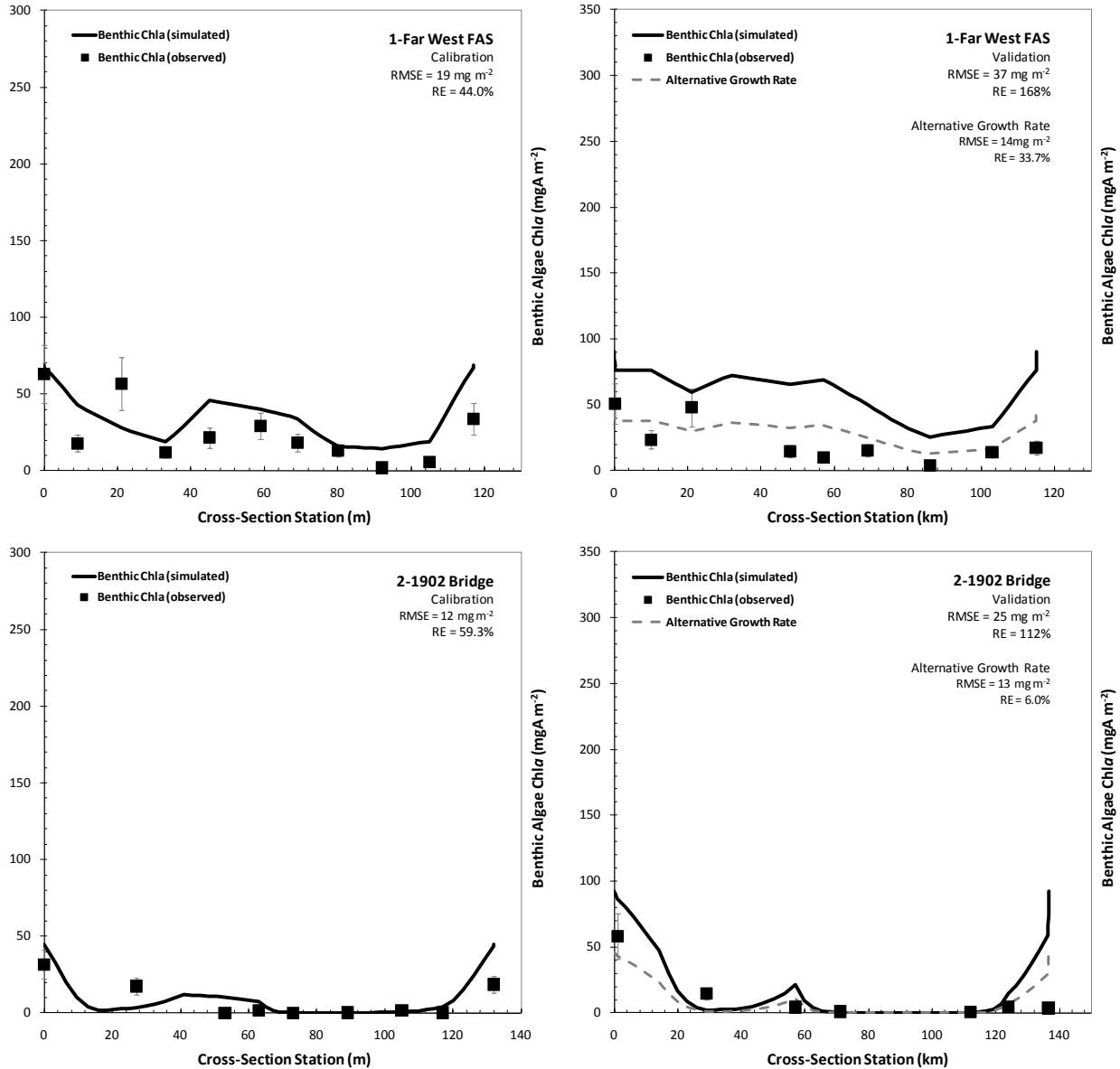

6

7

8

9

Figure 10-13. AT2K simulations of lateral algal distribution in Yellowstone River.

10 (Left panel) Simulated and observed values for each of the transects evaluated in August 2007. (Right panel) Same
 11 but for the validation. The alternative growth rate reflects the benthic algae growth rate determined previously to
 12 meet the productivity response of the river (see previous discussions). Field and lab variability estimated to be
 13 ±30% (DEQ, 2011).

14

15

16

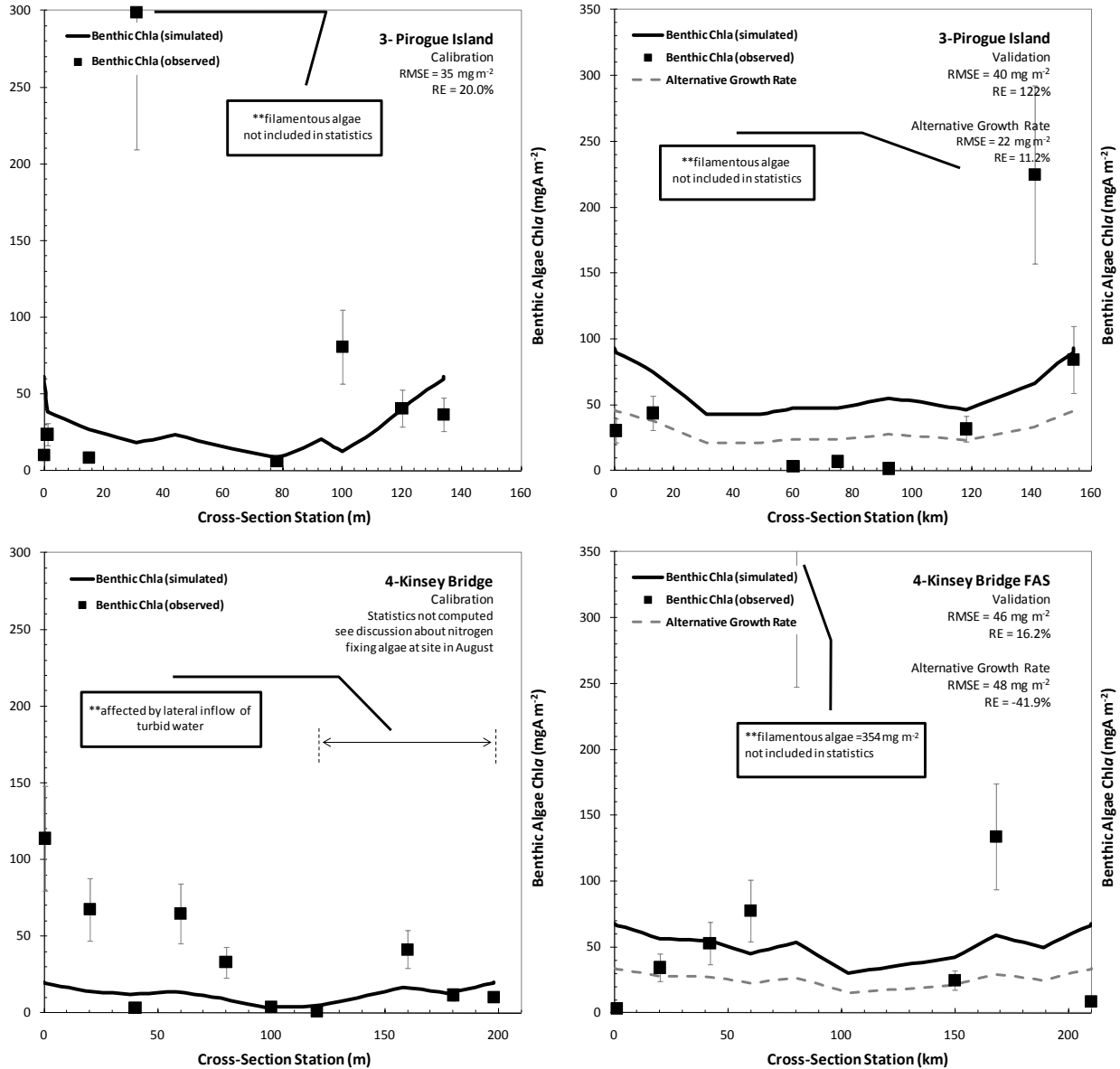

1

2

3

4

Figure 10-13. AT2K simulations of lateral algal distribution in Yellowstone River.

5

(Left panel) Simulated and observed values for each of the transects evaluated in August 2007. (Right panel) Same

6

but for the validation. The alternative growth rate reflects the benthic algae growth rate determined previously to

7

meet the productivity response of the river (see previous discussions). Field and lab variability estimated to be

8

±30% (DEQ, 2011).

9

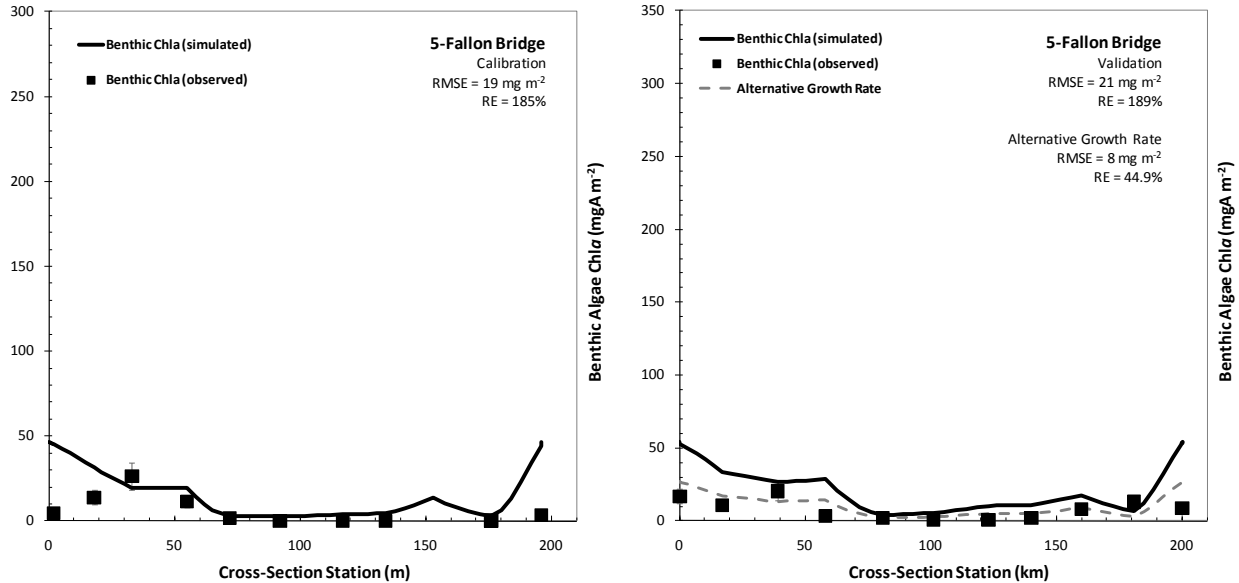

1
2
3
4
5
6
7
8

Figure 10-13. AT2K simulations of lateral algal distribution in Yellowstone River

(Left panel) Simulated and observed values for each of the transects evaluated in August 2007. (Right panel) Same but for the validation. The alternative growth rate reflects the benthic algae growth rate determined previously to meet the productivity response of the river (see previous discussions). Field and lab variability estimated to be $\pm 30\%$ (DEQ, 2011).

9 It should be noted that in **Figure 10-13**, AT2K does not adequately simulate Chla levels when the Chla measurement was unusually high, especially, when samples were dominated by long filamentous algae. In these places, long filamentous streamers of *Cladophora* spp. were present, which were sampled by the hoop method¹ (Freeman, 1986; Watson and Gestring, 1996). This technique integrates areal biomass from benthic growth that extends up into the water column and tends to produce higher biomasses. Diatom algae (which were most prevalent in the Yellowstone River) are different, and consist of a film on rocks and substrate, typically 0.5-5 mm thick that are sampled using a small template of known interior area that is placed on the substrate after which the algal material is scraped from it.

17 Long streamers of *Cladophora* such as those in isolated locations in the Yellowstone River present a difficult problem for the model. Currently, Q2K simulates benthic growth in one-dimension (i.e., longitudinally) which is normalized to reflect a 2-dimensional space (in areal units, mg Chla m^{-2}). Diatoms and short filaments essentially fit this scenario. In contrast, long *Cladophora* streamers actually protrude up into the water column and therefore exist in 3 dimensions (the volumetric space of the water

¹ Briefly, a metal hoop with interior area of 710 cm^2 is placed over the river bottom and only the algae streamers (or segments thereof) within the confines of the hoop are collected. Only 3% of the 2007 benthic algae samples on the Yellowstone River were collected via the hoop. This was because the vast majority of sampling locations encountered (97%) were dominated by diatom algae or mixes of diatoms and very short filaments of green algae (including short *Cladophora*).

1 column). These attach to rocks via small holdfasts and then grow up into the water under optimal
2 conditions (Dodds and Gutter, 1991). As such, *Cladophora* streamers can develop considerably higher
3 levels of biomass than algae growing strictly attached to the substrate because their space limitation
4 term is less limited. Neither QUAL2K nor AT2K can currently address this consideration.

5
6 In critique of our newly developed AT2K model, good agreement is seen at most locations in our cross-
7 sections (at least for the calibration). Since the vast majority of algal growth encountered during field
8 sampling (97%) was closely attached to the bottom (i.e., diatom-like), we believe the model is suitable to
9 represent the typical growing conditions that would be observed in the river at low-flow. One exception
10 would be the Kinsey Bridge FAS, which was much more productive than nutrient levels would suggest.
11 According to Charles and Christie (2011), nitrogen fixing *Epithemia sores*¹ were prevalent at this site and
12 made up nearly 50% of the overall periphyton community (**Figure 10-14**). Frustules of *Epithemia sores*
13 contain nitrogen-fixing endosymbiotic cyanobacteria which enable them to become abundant in
14 microhabitats, even those with low N/P ratios. It is not surprising then that even at low N levels, algal
15 biomass was still sufficiently high. In this instance, N-fixation likely provided the necessary N for algal
16 growth. A very large percentage of N-fixers were observed at this same site in August of 2000 (Peterson
17 and Porter, 2002).

18
19 To put the final AT2K simulation reliability into context, data from all cross-sections (excluding the
20 validation) were compiled and plotted on the 1:1 line (**Figure 10-15**, Left panel). By doing this, we find
21 that simulations tend to roughly be within $\pm 20 \text{ mg m}^{-2}$ (Kinsey FAS excluded), despite notable dispersion
22 in the data. This gives an estimate of model reliability, i.e., $\pm 20 \text{ mg m}^{-2}$ (the RMSE). The qualification of
23 this error is based on the assumption that the error is attributed to the model, not field data. However
24 in all reality it could likely be either, as previous work by DEQ has shown that the variability around the
25 true field mean can be as high as $\pm 30\%$ (DEQ, 2011b). Hence error could be attributed to field noise as
26 opposed to model uncertainty.

27
28 To assess which one of these it might be, cumulative frequency plots were constructed (again for the
29 calibration only) as shown in **Figure 10-15** (Right panel). Model simulations appear to represent the data
30 reasonably well, with the exception of less frequent higher biomasses. This perhaps suggests that the
31 model has difficulty in predicting very high biomasses even for diatoms (filamentous algae excluded
32 from this analysis), or that field observations were spurious and not entirely representative. An
33 appropriate margin of safety perhaps should be included to address quantification limits, which is
34 addressed in later sections in discussions regarding the nutrient criteria.

35
36 In lieu of previous discussions, we feel that the lateral benthic algae simulations in AT2K are sufficient to
37 answer the questions in which we are interested, provided that the assumptions and limitations of the
38 model are taken in proper context. Specifically it allows us the ability to gain better information about
39 spatial relationship of biomasses across a river transect, and in particular evaluate algal densities in the
40 Wadeable or near-shore environments.

¹ *Epithemia sores* is frequently found as an epiphyte on *Cladophora* and other coarse filamentous algae in western rivers. It is most common in N-limited habitats. Due to their ability to directly fix nitrogen from N_2 gas, they do not need aqueous nitrogen to maintain their biological metabolism.

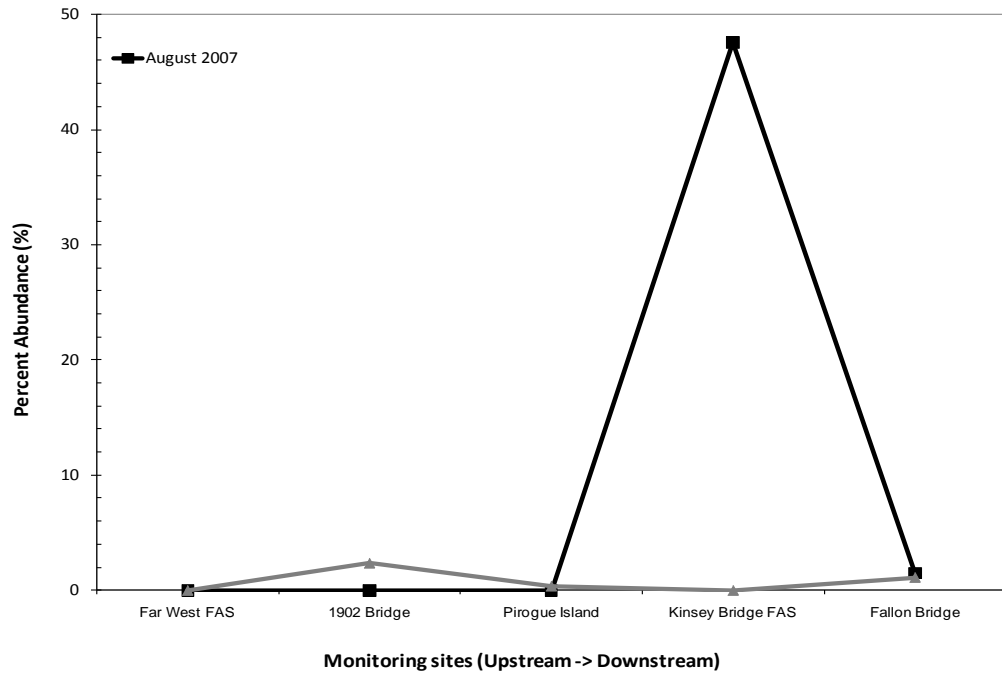

1
 2 **Figure 10-14. Percent abundance of nitrogen fixing *Epithemia sores* at Kinsey Bridge FAS in 2007.**
 3 The Kinsey FAS site was the only site with a large percentage of nitrogen fixing algae, which is suggestive of very
 4 strong nitrogen limitation. It also explains the deviation between the model simulations and observed algal
 5 biomasses at this site. Data reproduced with permission from Charles and Christie (2011).
 6

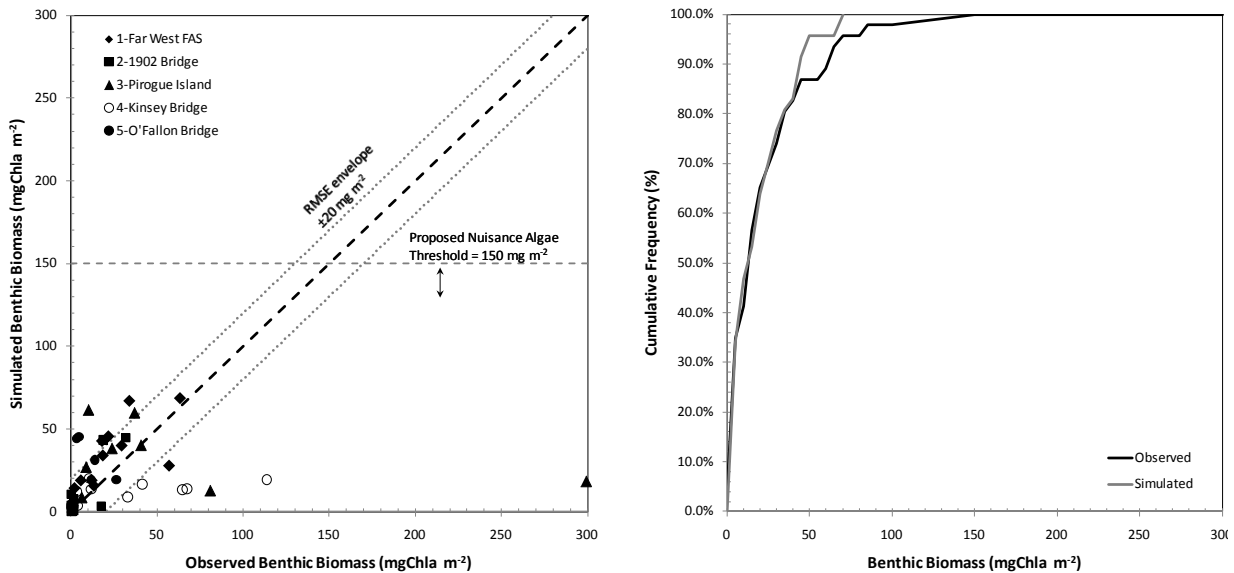

7
 8
 9 **Figure 10-15. Benthic algal biomass lateral simulation reliability.**
 10 (Left panel) 1:1 plots of model simulations for the calibration period. A RMSE envelope is shown which represents
 11 a plausible margin of safety to account for simulation error as discussed previously. (Right panel) Cumulative
 12 frequency plot of simulated and observed benthic algal biomasses for the August 2007 period indicating relatively
 13 consistent simulation of lower biomasses and tendency to underestimate higher biomasses.
 14

10.4.3.3 Phytoplankton

Phytoplankton simulations reflect algae that are in suspension, primarily plankton or displaced benthic algae. Plankton increase due to photosynthesis and are lost via respiration, death, and settling. DEQ has two different lines of data to evaluate phytoplankton simulations. These are: (1) integrated EWI field samples and (2) continuous fluorescence measurements from our YSI sondes¹.

As shown in **Figure 10-16**, concentrations of phytoplankton differed significantly between the August and September (8 to 16 $\mu\text{g L}^{-1}$ in August, and 4 to 12 $\mu\text{g L}^{-1}$ in September), but were well represented both periods. In both instances we met our QAPP requirement of $\pm 10\%$ (using the sonde data) and RMSE and RE were between 1.9-3.2 $\mu\text{g L}^{-1}$ and -16.3 to -2.0% during calibration and 1.1-3.0 $\mu\text{g L}^{-1}$ and -3.0 to -17.3% in validation (depending on which data source was considered). Phytoplankton tended to increase in the downstream direction with an apparent plateau near the downstream end of the study reach. This reflects the point where light and nutrient limitation is near their maximum.

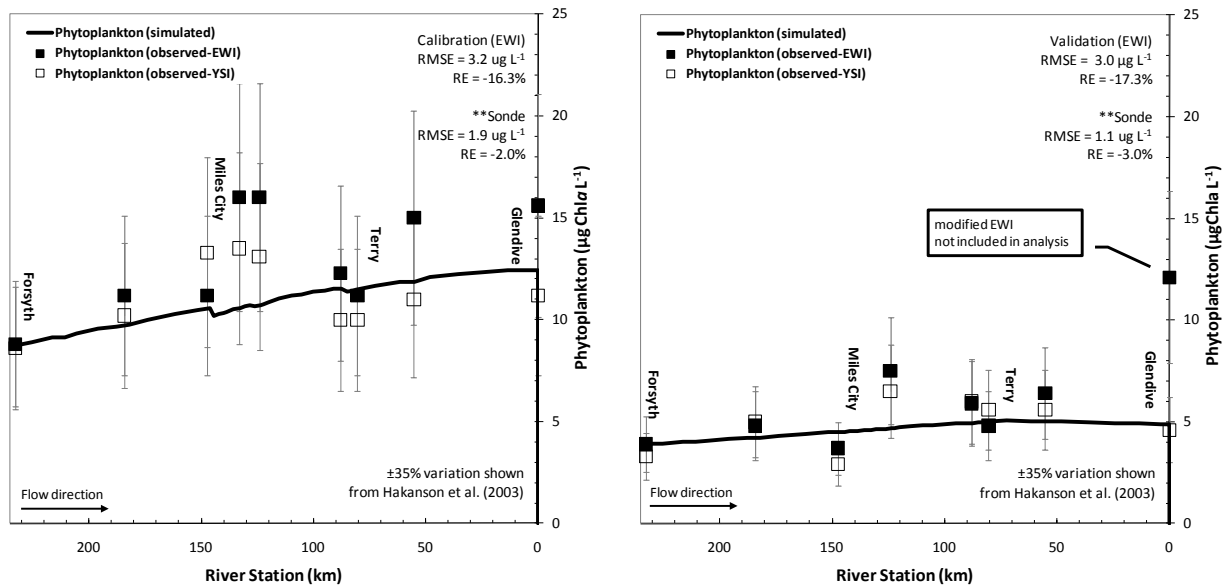

Figure 10-16. Phytoplankton simulations for the Yellowstone River during 2007.

(Left panel) Simulated and observed phytoplankton Chl a simulations for the August 2007 calibration period. (Right panel) Same but for the September validation. Both the EWI and sonde data are shown.

¹ The sondes were calibrated to field Chl a measurements. A simple 1:1 empirical adjustment was made at each site (a different one for each data collection period). For example, if the sonde recorded a Chl a value of 10.0 $\mu\text{g L}^{-1}$ and the measured Chl a value was 8.0 $\mu\text{g L}^{-1}$, the entire time-series for each sonde was adjusted by a factor of 0.8. Due to the daily variation in sonde data (especially suppression of fluorescence) these calibrations were completed over a 1- or $\frac{1}{2}$ -day average period after the YSI sonde was cleaned.

10.4.4 Oxygen

Dissolved oxygen (DO) is a very important indicator of river productivity and was heavily relied upon in model calibration¹. Oxygen is gained from photosynthesis and lost via CBOD oxidation, nitrification, plant respiration, and sediment oxygen demand. Depending on saturation, it can also be gained or lost through reaeration. In review of our DO simulations, the model performed reasonably well for the calibration and poorly for the validation (**Figure 10-17**, Top left/right panel). Despite the latter, we still met the QAPP DO requirements (± 10) with RMSE=0.59 and 0.63 mgO₂ L⁻¹ and RE=-2.5 and 0.21%. In the validation, diurnal DO was somewhat beyond what we felt acceptable. As indicated in previous sections, the alternative growth rate resulted in better simulations (RMSE=0.42 mgO₂ L⁻¹ and RE=-2.5%).

The Yellowstone River exhibited several distinctive areas in regard to DO. The effects of the Cartersville Diversion dam (located just downstream of the Forsyth site) are clearly shown at km 231.5, and push the minimum and maximum diurnal DO prediction towards saturation. Diel DO patterns then quickly recover and are fairly consistent until reaching Miles City (km 150), where river productivity increases due to wastewater contributions and changes in river morphology. The change only occurs for a short period and then productivity declines from that point downstream. In essence, this marks the point where benthic algae dominance ceases and the river becomes a turbid, phytoplankton-dominated system.

We were unable to capture the full magnitude of the daily diurnal DO variation near Miles City. At least some of our apparent inability could be related to incomplete lateral mixing² of wastewater effluent in the observed area. Calculated lateral mixing length below the WWTP was considerably longer than the distance to the sonde (at station km 133), as well as the next sonde downstream³. This suggests that the wastewater effect might have been larger on one side of the river than the other and was causing

¹ We feel that DO is a good indicator because it reflects community photosynthetic response and is reliably measured. We used the YSI 6600 sondes extended deployment system (EDS) which has an optical probe and provides some of the best field measurements possible (accurate calibration, minimal long-term drift). Additionally, we quantified many of the sources and sinks of DO in the field.

² The sonde at km 133 (the one with the large diurnal variation) was on the right bank which was the same side as the wastewater discharge while the next downstream sonde (km 124) was on the opposite bank and had a more moderated diel swing.

³ Lateral mixing length in meters (L_m) is calculated according to Chapra (1997) using the Fischer, et al.,

(1979) formula, where $L_m = 0.4U \frac{B^2}{E_{lat}}$ and U =velocity (m s⁻¹), B =channel width (m), and E_{lat} =the lateral dispersion coefficient. The lateral dispersion coefficient can be calculated as: $E_{lat} = 0.6HU^*$, where U^* is the critical shear velocity (m s⁻¹) and H =depth (m). Critical shear is calculated as $U^* = \sqrt{gHS}$, where g =acceleration of gravity (m s⁻²), and S = slope (m m⁻¹), and for this reach, U^* was estimated to be 0.077 m s⁻¹ ($S=0.00081$, $H=0.75$). Given $B = 150$ m and $U=0.7$ m s⁻¹, L_m would be very large (181 km).

1 deviation between the simulated and apparent¹ observed data. Due to this possibility, we are not overly
 2 concerned about the deviation between the model and the field data at this location.
 3 Diurnal model evaluations also provide insight into short-term field processes such as photosynthesis
 4 and respiration. We evaluated two sites located at approximately $\frac{1}{3}$ and $\frac{2}{3}$ of the overall reach (km 147.5
 5 and km 55.3). Modeled diurnal DO is quite reasonable (**Figure 10-17**, Bottom left/right panel) and
 6 minima occur near daybreak (6:00 a.m.), with means near midday and midnight, and maximums near
 7 5:00 or 6:00 p.m. The influence of solar noon on algal productivity, respiration, and reaeration typify the
 8 sinusoidal DO pattern over the day (Chapra and Di Toro, 1991b; Odum, 1956).
 9

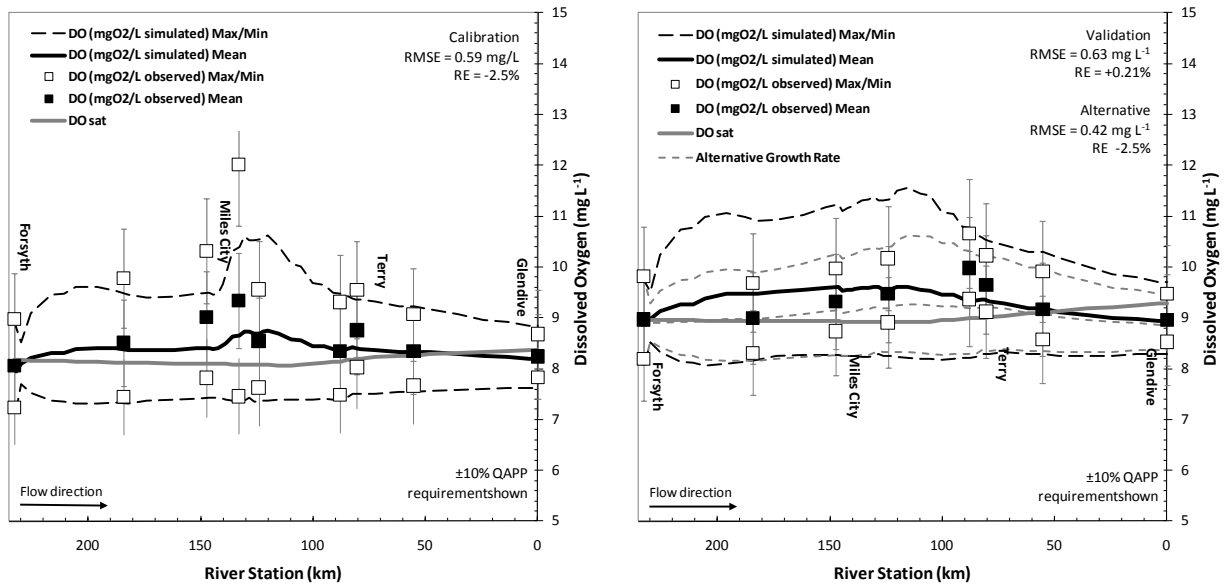

10

¹ The word “apparent” was used due to concern about lateral mixing described previously and the fact that the sonde data may not have been reflective of the overall condition of the river.

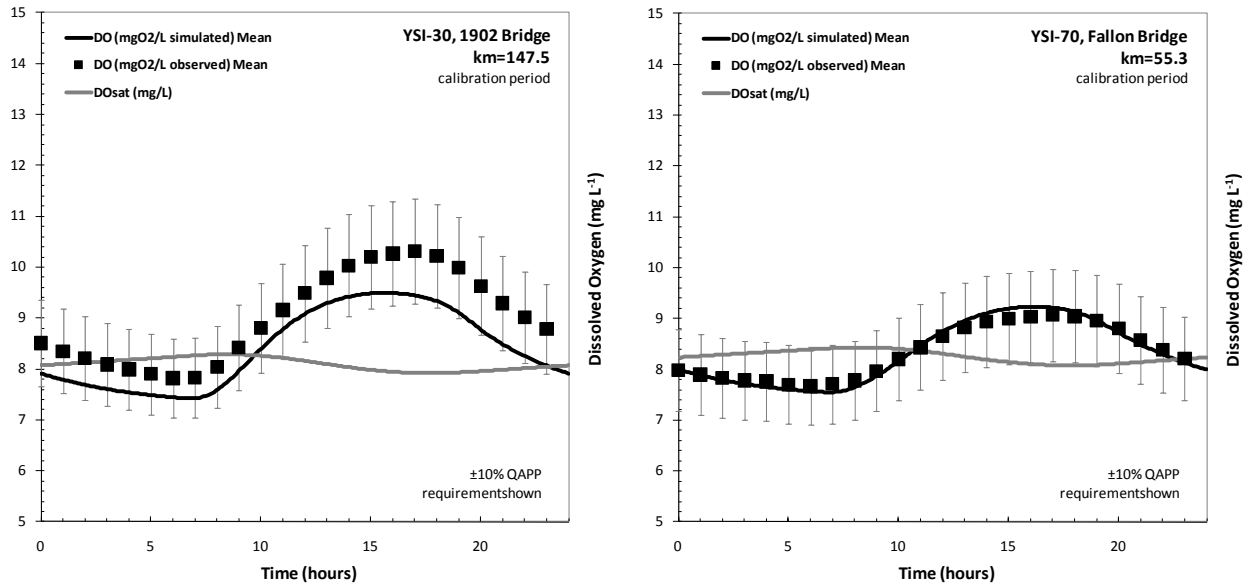

1
2 **Figure 10-17. DO simulations for the lower Yellowstone River during 2007.**

3 (Top left/right panel) Simulated and observed DO for August and September 2007. The highest areas of
4 productivity are near Miles City and moderate downstream due to light limitation. (Bottom left/right panel)
5 Diurnal simulations for the 1902 Bridge (km 147.5) and Fallon Bridge upstream of O’Fallon Creek (km 55.3) which
6 are roughly at $\frac{1}{3}$ and $\frac{2}{3}$ of the project reach length.
7
8

9 10.4.5 Carbon

10 11 10.4.5.1 pH and Alkalinity

12
13 Both pH and alkalinity are related. The former varies as a function of total inorganic carbon (C_T) which
14 increases due to carbon oxidation and respiration and decreases due to photosynthesis (reaeration
15 causes either an increase or decrease depending on saturation). Alternatively, alkalinity is a measure of
16 the river’s ability to neutralize acids (buffering capacity) or maintain a pH. Many processes affect
17 alkalinity including nitrification and denitrification, OrgN/P hydrolysis, photosynthesis, respiration,
18 nutrient uptake, and excretion by both benthic algae and phytoplankton.
19

20 As shown in **Figure 10-18** (Top left/right panel), pH simulations for the Yellowstone River were fairly
21 good in calibration and marginal for validation (similar to what was described previously for other state-
22 variables). RMSE and RE were 0.16 and 0.18 pH units and 0.9 and 1.2% respectively. The alternative
23 growth rate yielded very similar results with an RMSE=0.16 and RE=-1.1%. Simulated pH tracks well with
24 known areas of productivity and is greatest in areas of the highest algal growth (i.e., photosynthesis
25 reduces available carbon dioxide and subsequently carbonic acid and hydrogen ion concentration).
26 Diurnal variability is greatest in these locations as well (e.g., near Miles City, km 150).
27

28 In calibration, pH was found to depend more on the groundwater influx than any of the surface water
29 exchanges. Shifts were apparent at each of the major tributaries (Tongue River and Powder River), and
30 the concentration could only be adequately simulated through calibration. Incoming pH was found to be
31 more like surface water than groundwater based on comparison of the calibrated activity with that of
32 the groundwater data compilation. The key difference was believed to be subsurface water returning to

1 the river from irrigation return flow. This was validated through the calibration of conductivity as
 2 detailed in **Section 10.5.6**.

3
 4 Alkalinity was also evaluated (**Figure 10-19**, bottom), but little can be said due to the fact that we only
 5 collected a single round of alkalinity measurements to make model comparisons¹. RMSE and RE were
 6 1.5 and 2.5 mgCaCO₃ L⁻¹ and 0.0 and -1.4%. Statistical values probably best reflect an estimate although
 7 we do feel the simulations reasonably represent conditions during 2007. Values were consistently 170
 8 mg CaCO₃ L⁻¹, with only slight shifts near the Tongue and Powder Rivers.

9
 10

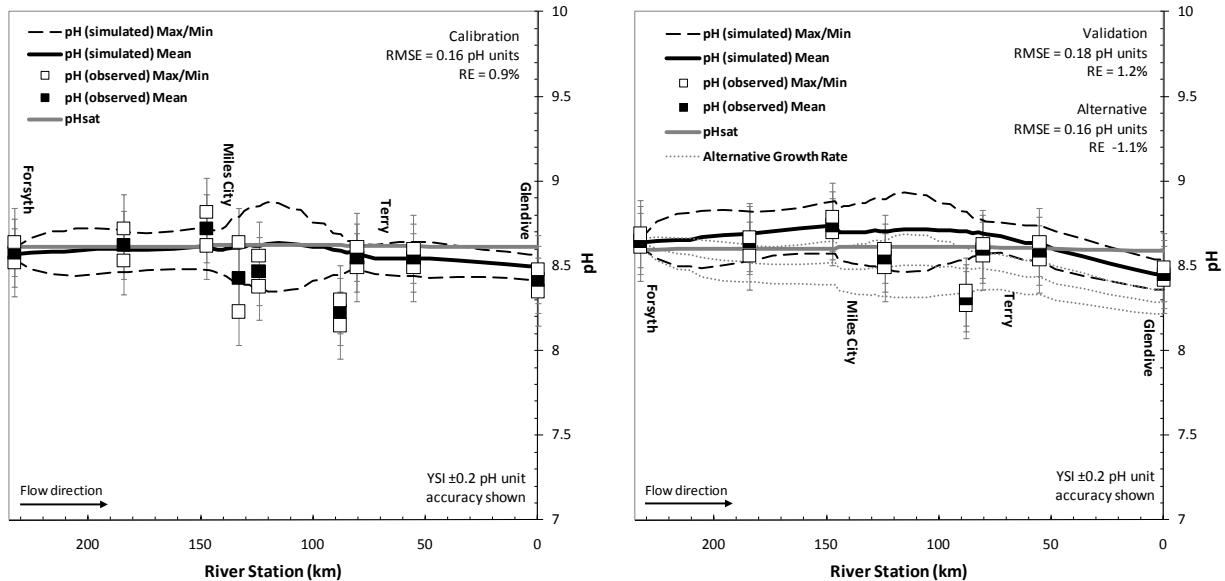

¹ Alkalinities were monitored only in September, and only on the mainstem river and influent WWTPs. Estimates were made for rest of the tributaries using the geometric mean of the values over the August and September measurement period at USGS gage sites. If no gage was present, a reasonable approximation was made from nearby field data.

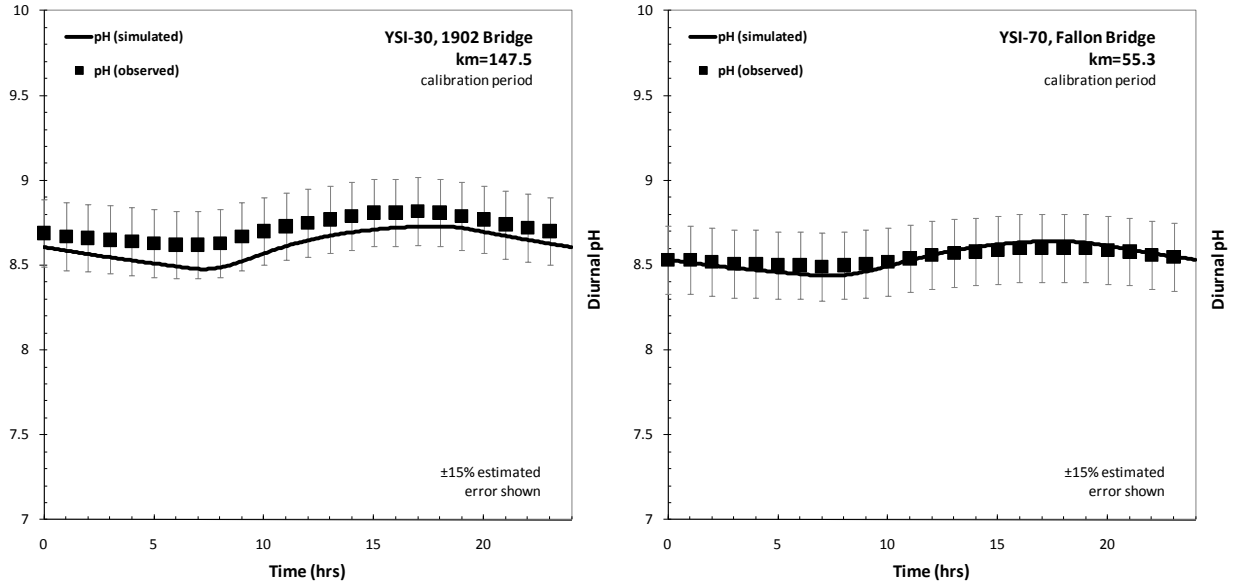

1
2
3
4
5
6
7
8

Figure 10-18. pH simulations for the Yellowstone River during 2007.

(Top left/right panel) Simulated and observed pH for the August and September 2007 calibration and validation periods. (Bottom left/right panel) Diurnal simulations for several of the sites previous; the 1902 Bridge (km 147.5) and Fallon Bridge upstream of O’Fallon Creek (km 55.3).

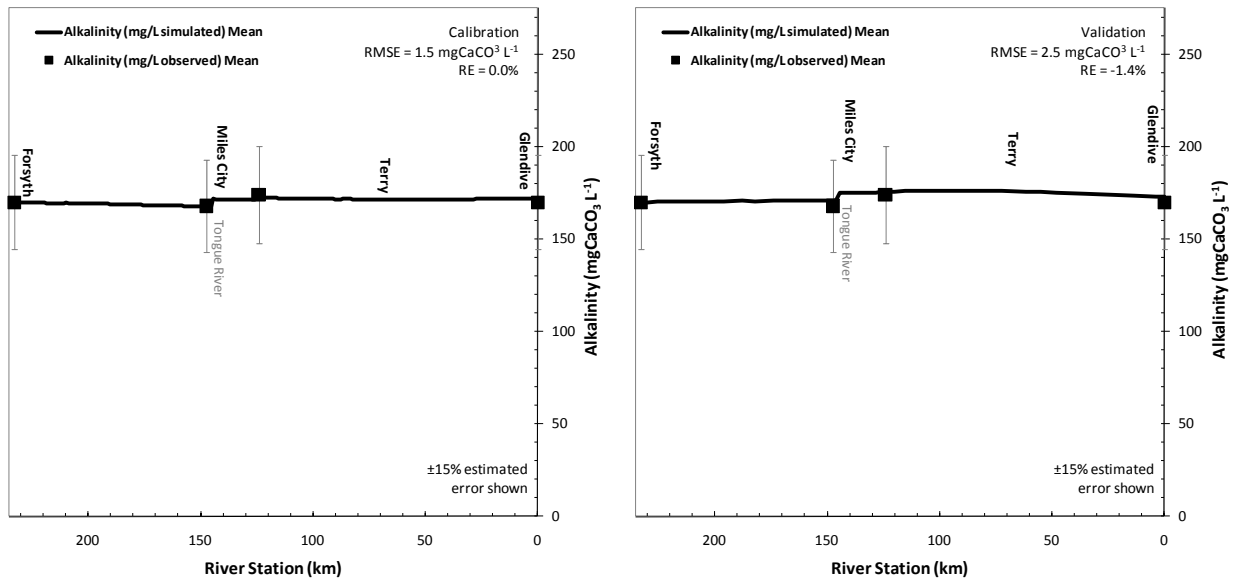

9
10
11
12
13
14
15

Figure 10-19. Alkalinity simulations for the lower Yellowstone River during 2007.

(Left panel) Simulated and observed alkalinity for the August 2007 calibration period. (Right panel) Same but for the validation period.

1 **10.4.5.2 CBOD**

2
 3 Carbonaceous biochemical oxygen demand (CBOD) reflects the oxygen demand exerted on the river
 4 through oxidation of carbon (redox reactions). Only one type of CBOD (fast, $CBOD_f$) was modeled as all
 5 forms of CBOD on the Yellowstone River were anticipated to be similar. $CBOD_f$ is gained from the
 6 dissolution of detritus and is lost from oxidation and denitrification. In 2007, we measured 5-day $CBOD_f$.
 7 Values were quite low, below the analytical reporting limit of 4 mg L^{-1} . Therefore we only had
 8 unreported laboratory values available to us which were 2.3 and 0.32 mg L^{-1} for August and September
 9 and were determined to be unreliable. We chose to use historical field dissolved organic carbon (DOC^1)
 10 data normalized to CBOD units² to estimate $CBOD_f$ instead.

11
 12 Model comparisons were made with CBOD-ultimate ($CBOD_u$) which is the sum of $CBOD_f$ (as described in
 13 the previous paragraph) and CBOD in particulate form ($CBOD_p$). Since particulate organic carbon was
 14 measured in the field, we simply assumed that 2.67 grams of oxygen were required to oxidize one gram
 15 of particulate carbon and summed this with our previous estimate. $CBOD_u$ model simulations are shown
 16 in **Figure 10-20** (Top left/right).

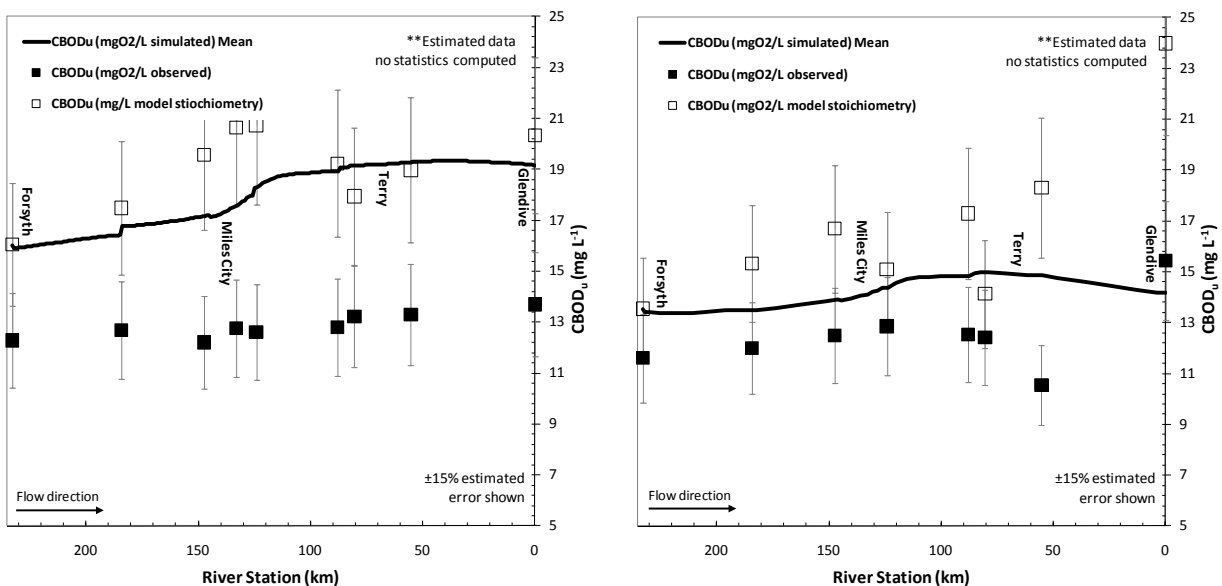

17

¹ The particulate organic carbon (POC) measurements between 2000 and 2007 were very similar. Both were approximately 1 mg C L^{-1} at Forsyth. Hence we assumed DOC to be similar between the years.

² It was assumed that all of the organic carbon would ultimately be oxidized. The stoichiometric mass

relationship of 2.67 : 1, or $\frac{1 \text{ mole } O_2}{1 \text{ mole } C} \times \frac{32 \text{ g } O_2}{1 \text{ mole } O_2} \times \frac{1 \text{ mole } C}{12 \text{ g } C}$ was used.

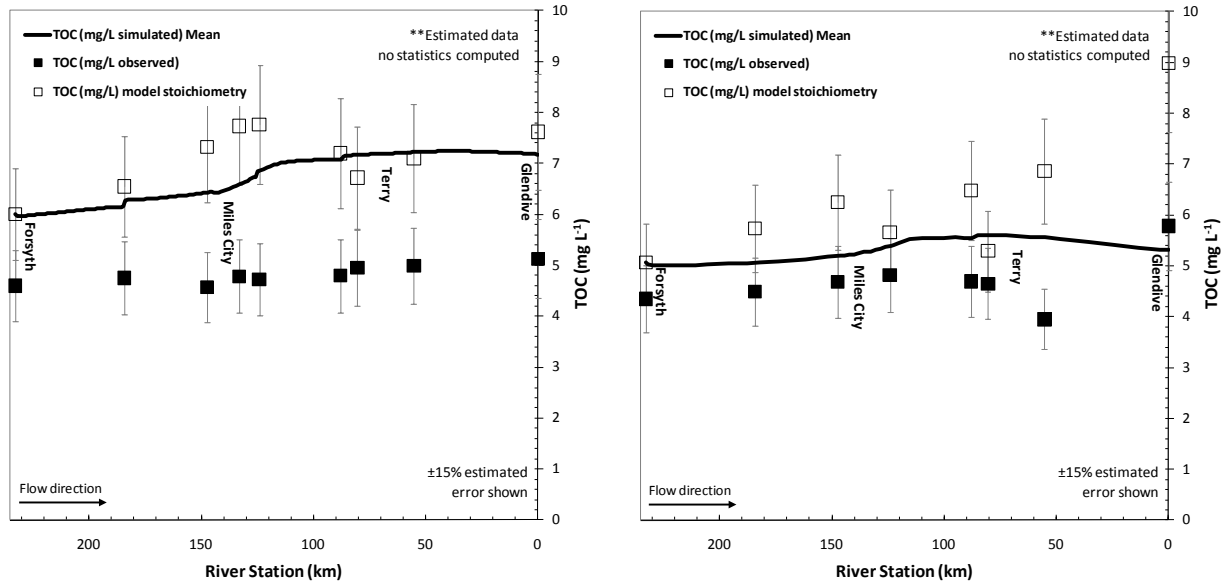

1
2 **Figure 10-20. CBOD-ultimate and TOC simulations for the Yellowstone River during 2007.**
3 (Top left/right panel) Simulated and estimated observed CBOD for the calibration and validation respectively.
4 (Bottom left/right panel). Same but for TOC. The filled squares reflect the actual CBOD/TOC estimates for the river
5 while the open squares reflect the data if calculated from the model stoichiometry (see discussion in text). The
6 consistent deviation between the two data requires a correction factor of approximately 0.65.

7
8 Overall, we see that $CBOD_u$ is over-simulated in all instances, but by a similar percentage. The deviation
9 stems from the fact that carbon to detritus ratio is assumed to be $\approx 2.5:1$ (107:43), typical of algae when
10 they die (Chapra, et al., 2008). However, the actual detrital makeup of the river is far removed from
11 that, more on the order of 9:1 (perhaps allochthonous or of terrestrial origin). Thus we have artificially
12 inflated the amount of carbon in detritus and overestimated $CBOD_u$. Checks can still be used see if the
13 model is reasonable by correcting the field data with the implied stoichiometry. This has been done and
14 is shown in the figures. With this understanding, we feel that the model simulates CBOD reasonably
15 (despite the problems mentioned previously) and that the overall longitudinal profile of the river is well-
16 represented. A relatively constant increase in CBOD occurs until Miles City (km 150), is followed by a
17 marked increase due to increases in productivity, and then finally decreases in the lower river due to
18 light limitation. In all instances, CBOD simulations are 35% high, and carbon in the model must be scaled
19 down by a factor of 0.65 to reflect actual field conditions. This overestimation slightly affects computed
20 pH values in the model (more C_T causes a decrease in pH).

21 22 **10.4.5.3 Total Organic Carbon (TOC)**

23
24 TOC is calculated by Q2K as the sum of DOC (dissolved carbon) and POC (suspended carbon) and is
25 affected by the previous discussion in regard to carbon inflation. TOC was not collected or analyzed, but
26 is shown in **Figure 10-20** (Bottom left/right) where the observed data reflect the sum of the carbon in
27 phytoplankton and detritus. Simulated TOC values range from around 5-6 $mg\ C\ L^{-1}$ at the headwater to
28 around 6-7 $mg\ C\ L^{-1}$ at the end of the reach which must be adjusted down by a multiplier of 0.65 to
29 reflect the true carbon content of the river. No statistics were computed for TOC given this
30 consideration and the lack of available data. Given that TOC in the river is already above the drinking
31 water regulatory threshold of 2 $mg\ C\ L^{-1}$ (where treatment for disinfection by-products becomes a

1 requirement), and is in an adjusted range of 3.3-4.6 mg C L⁻¹, it may not be a direct factor in criteria
 2 development for the river.

4 10.4.6 Conductivity

6 Conductivity is a conservative substance (i.e., reflective of salts in solution) and a good overall check on
 7 the validity of the model. Although unrelated to nutrients, it is presented here as final consideration.
 8 Conductivity simulations were fairly consistent in 2007 and were primarily a function of headwater
 9 conditions and slight changes coincident with groundwater inflow and major tributaries. As identified
 10 previously, the conductivity accretion caused us to believe that the primary recharge source in the
 11 region was irrigation conveyance losses as relatively clean low influent water was needed to calibrate
 12 the model (as opposed to the fairly saline regional groundwater flow systems).

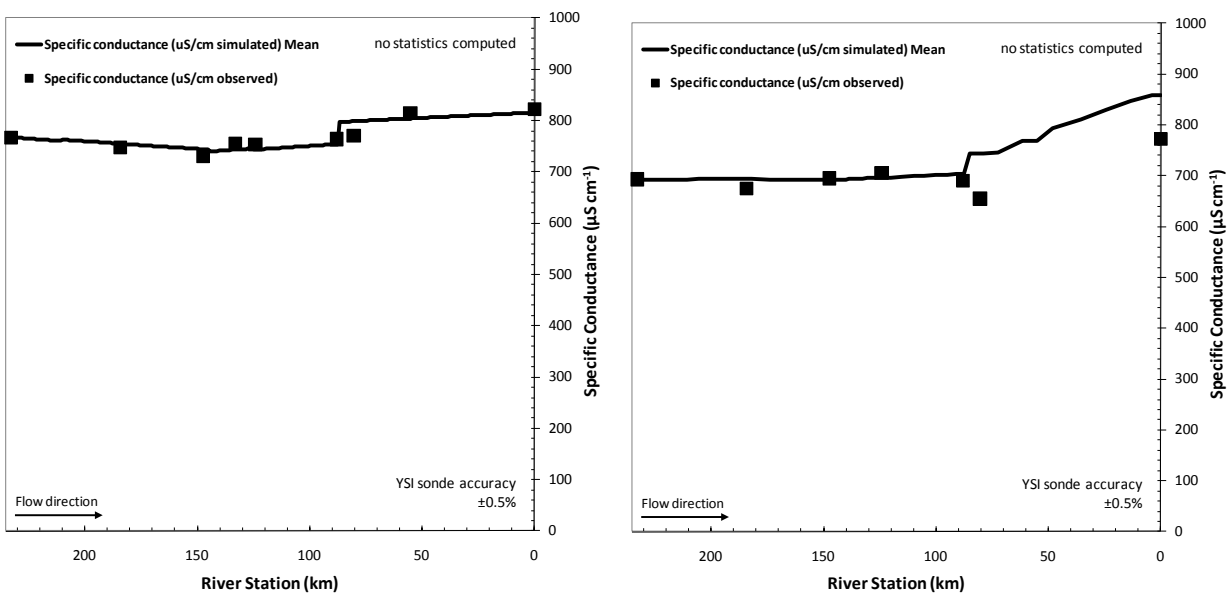

14 **Figure 10-21. Conductivity simulations for the Yellowstone River during 2007.**

15 (Left panel) Simulated and observed conductivity for the August 2007 calibration period. (Right panel) Same but for
 16 the validation period.

1

11.0 MODEL EVALUATION BEYOND THE ORIGINAL VALIDATION

It was apparent in the previous section that difficulties were encountered during model validation. We were able to isolate this to a specific compartment in Q2K (benthic algae), but additional information was needed to make any robust conclusions about the model's predictive utility. Outside expertise from the Philadelphia Academy of Natural Sciences (PANS) was consulted to evaluate differences between the August and September 2007 data. We also completed a second validation using a low-flow dataset collected by U.S. Geological Survey (USGS) in August of 2000. Each of these activities is detailed below.

11.1 Phycological Evaluation and Growth Rate Changes as Evidenced by Algal Taxa

Taxonomic evaluations of algae from the Yellowstone River were completed by phycologists at PANS (i.e., those who specialize in algae taxonomy and ecology) using the August and September 2007 data. Samples collected by USGS in 2000 were also included. While no single overwhelming difference was identified between the two periods, the following dissimilarities were noted (Charles and Christie, 2011):

- **Differences in Algal Taxa** – PANS identified that algal counts in August 2007 and September 2007 showed noted differences in the relative abundance of taxa (20% different), most notably that significant proportion of the diatoms were in the eutrophentic (i.e., high productivity) category during August. Eutrophentic species are often associated with higher nutrient conditions and faster growth rates. Likewise, the percentage of dominant taxa was higher in August than September which typically occurs with higher growth rates.
- **Changes in 3-D Structural of benthic algal matrix** –The percentage of motile taxa (i.e., those that can move up or down in the algal mat) were also higher in August than September of 2007 suggesting that the algal mat may have been thicker and more productive in August than September. There was also a higher relative biovolume of *Cladophora* in August than September. *Cladophora* provides a three-dimensional structure for algal growth that allows more efficient and greater use of light and also provides a greater surface area on which diatoms can grow. Diatoms tend to have a faster growth rates than filamentous algae.

A number of other, less probable causes were also identified (Charles and Christie, 2011). For example, it was suggested that changes in phytoplankton density from August to September could be responsible for the shift. However, the model already accounts for the phytoplankton shift and both simulation periods were well represented in the model. A second possibility was photosynthetic use efficiency changed (i.e., adjustment of *Chla* levels to varying light levels). Hill, et al., (1995) found that shaded periphyton were two times more efficient in their photosynthetic response at low-irradiance than non-shaded periphyton and similarly, algae are capable of adapting to very low irradiances with respect to growth rate (Falkowski and LaRoche, 1991; Rier, et al., 2006). However, we didn't necessarily see this in our field data (i.e., shifts in *Chla* to ash-free dry weight ratio) and likewise, the light half-saturation constants used in the modeling were near the middle of the range reported in the literature (Hill, 1996). Thus there was no reason to believe that a major shift in light use efficiency occurred.

Finally, PANS noted differences in water temperature between the periods. A change of about 5°C occurred between August and September (from 21°C to 16°C), which from a theoretical standpoint

1 would reduce the rate of productivity by about 25% (i.e., a doubling in growth rate occurs per 10°C).
2 Such changes are already accounted for in the model and adjustments outside of the range of Eppley
3 (1972) seem inappropriate.

4
5 A final consideration is senescence. The process is not well understood in algae, but there are four
6 commonly recognized causes for growth termination at the batch culture level in the laboratory. These
7 include changes in: (1) pH, (2) CO₂ concentration, (3) light, and (4) nutrients (Daley and Brown, 1973).
8 The most measurable response is a decline in photosynthetic productivity (less DO production)
9 accompanied by alteration of C : Chl_a ratios. Senescence-like responses occur seasonally in response to
10 photoperiod (i.e., the length of the day) (Suzuki and Johnson, 2001) which reflect the ability of plants
11 and animals to sense the duration of the day and/or night and to respond appropriately. Specifically, this
12 has been observed in algal spore germination for the purpose of overwintering (Suzuki and Johnson,
13 2001).

14
15 One such example has been observed in Montana's prairie streams. In the 2010, we found senesce to
16 occur in Box Elder Creek in late September/early October (DEQ, 2010). This was about 50 days after
17 nutrient additions were commenced in the study, but prior to their termination (i.e., the effect was not
18 related to nutrient depletion but to water temperature and length of day; similar to when leaves fall off
19 terrestrial vegetation in autumn). The most noted response was a significant accumulation of
20 dead/dying algae in the stream, an occurrence similar to the matt accumulations found on the shoreline
21 of the Yellowstone River during late September 2007. Perhaps, then, senescence is another
22 consideration.

23
24 In summary, there are a number of possible explanations for our apparent inability to represent the
25 river during fall 2007. Whatever the true explanation be, the river was undoubtedly more productive in
26 August than September which was somewhat related to benthic algae. We confirmed this through two
27 lines of evidence, our simulation analysis as well as the expert review by PANS. Adjustment of the algal
28 growth rate in the model was a simple remedy to fix the problem (which could have been done though a
29 number of other possible mechanisms) which was, in effect, our refinement beyond the original
30 calibration. However, because questions regarding the rigor of such an approach may remain (i.e., is the
31 model really validated) we further addressed this concern below.

32 33 **11.2 Cross-Validation with 2000 USGS data**

34
35 A second piece of validation work was completed by DEQ using an independent dataset collected by
36 USGS during August of 2000 (Peterson, et al., 2001). This "cross-validation" allowed for a second chance
37 at model confirmation. Both pros and cons of such an approach are summarized below.

38 39 Pros:

- 40 • Data collection from 2000 took place at a similar time in August (near the peak of productivity)
41 and therefore may be better suited to our original calibration.
- 42
43 • Hydrologic conditions during 2000 were very similar to 2007, but were quite different in terms
44 of water quality, thereby representing a set of different loading conditions .

- 1 • Algal taxa were different in 2000 compared to 2007. The percent similarity was between 20-
2 30% (Charles and Christie, 2011). This allows us to compare and contrast the effect of taxa
3 differences on river conditions.
- 4
- 5 • The conditions of the model (i.e., low-flow and warm climate) are very similar to the hydrologic
6 design flows used later for criteria development.
- 7
- 8 • Data was collected on a much larger section of the lower river extending from Billings to Sidney,
9 MT allowing evaluations over a much larger spatial extent.

10
11 Cons:

- 12 • The data were not collected specifically for the purpose of modeling.
- 13
- 14 • Detection limits used in the USGS study were not as low as desired (e.g., they were $\text{NO}_3^- = 50 \mu\text{g L}^{-1}$,
15 $\text{NH}_4^+ = 20 \mu\text{g L}^{-1}$, and $\text{SRP} = 10 \mu\text{g L}^{-1}$). These present problems in understanding biological
16 responses to low-level soluble nutrients.
- 17
- 18 • There was less diurnal data (e.g., DO, pH, SC, turbidity) specific to our project reach. Only three
19 sites had data (Forsyth, Miles City, and Terry).
- 20
- 21 • The more detailed features of 2007 (e.g., irrigation withdrawals or return flows, smaller
22 tributaries, WWTP contributions, etc.) were not monitored by USGS.
- 23
- 24 • A different method was used to characterize benthic algae biomass. We used cross-sectional
25 averages while USGS characterizes the richest target habitat.

26
27 Based on the considerations above, we felt that the pros of using the USGS dataset outweighed the
28 cons. One of the most attractive features being that it was collected during another low-flow year and
29 during peak productivity (precisely the condition the model is being built to simulate).

30
31 In development of the 2000 model, steps identical to those described in **Section 9.0 and 10.0** were used.
32 Because diurnal data were only available for three locations in our modeling extent (4 of the sites had
33 chemistry data), the confirmation model was for the entire lower river from the USGS gage at Billings to
34 the Montana state line. This encompassed the following sites: the Yellowstone River at Billings (diurnal
35 & water chemistry), the Yellowstone River at Custer (diurnal & water chemistry), the Yellowstone River
36 at Forsyth (diurnal & water chemistry), the Yellowstone River at Miles City (diurnal & water chemistry),
37 Yellowstone River at Terry (diurnal & water chemistry), the Yellowstone River at Glendive (water
38 chemistry), and the Yellowstone River at Sidney (diurnal & water chemistry). The longer reach provides a
39 more robust validation in that it is an overall check of calibrated rates to longer area of the river (while
40 still within class B-3 waters).

41

1 A longer length model did have its drawbacks. First and foremost, locations outside of our 2007 study
2 reach (e.g., Billings to Forsyth and Glendive to Sidney) did not have detailed data¹. We used as much
3 discretion as possible to fill data gaps. In many cases we applied details of tributary flows, irrigation
4 exchanges, etc. from the 2007 period to the 2000 dataset. Results of the model validation are described
5 in the following sections. Overall we found that model performance was acceptable. Comparisons were
6 only made for data that was collected during 2000 including: TSS, nutrients, algae, and diurnal DO, pH,
7 and temperature data. Statistical results have been detailed previously in **Section 10.0**.

9 **11.3 Results**

11 **11.3.1 Streamflow Hydrology**

12
13 In 2000, streamflows ranged from between $50 \text{ m}^3 \text{ s}^{-1}$ near Billings (km 590) to just over $120 \text{ m}^3 \text{ s}^{-1}$ near
14 Miles City (km 310) and Glendive (km 280). Simulated and observed streamflows are shown in **Figure**
15 **11-1**. Overall, the model reflects the water balance quite well. The two primary drivers were the inflow
16 of the Bighorn River which effectively doubles the flow at km 490, and then numerous declines from
17 irrigation throughout the lower river (Huntley, Waco-Custer, Rancher's, Yellowstone, etc.). Values for
18 the irrigation diversions in the non-detailed study reach were estimated from irrigated area in the DNRC
19 water resource surveys (as done in the 2007 model) and also by bringing the simulated and observed
20 streamflow data into agreement. Note that the gage at Glendive was not in operation in 2000.

¹ As a result, the larger model (Billings to State Line) is skeletal in regions outside the detailed study area and accounts only for major tributaries and features (e.g., Billings WWTP, Huntley Diversion Dam, Bighorn River, etc.). Stationing for the model was based on the 2001 color-IR centerline (converted to km) as used previously (AGDTM, 2004). Locations of diversion dams were identified through the U.S. Fish and Wildlife Service (U.S. Fish and Wildlife Service, 2008). Many simplifications were subsequently necessary due to a lack of data in the unmonitored reaches, in particular, relative to irrigation practices and river hydraulics. To make up for these deficiencies (and any discrepancies in the hydrology mass balance) an accretion term was added to the model to ensure simulated streamflows at each gage were correct. Likewise, if any differences in temperature, pH, etc., were identified, they too were accommodated through the diffuse accretion term (again only in the non-detailed study reach) to improve the simulation. In the detailed study reach (Forsyth to Glendive), information was kept exactly as in the 2007 model (river stationing, irrigation, etc.). The only adjustment was gaged tributary inflows and associated water quality boundary conditions measured in 2000.

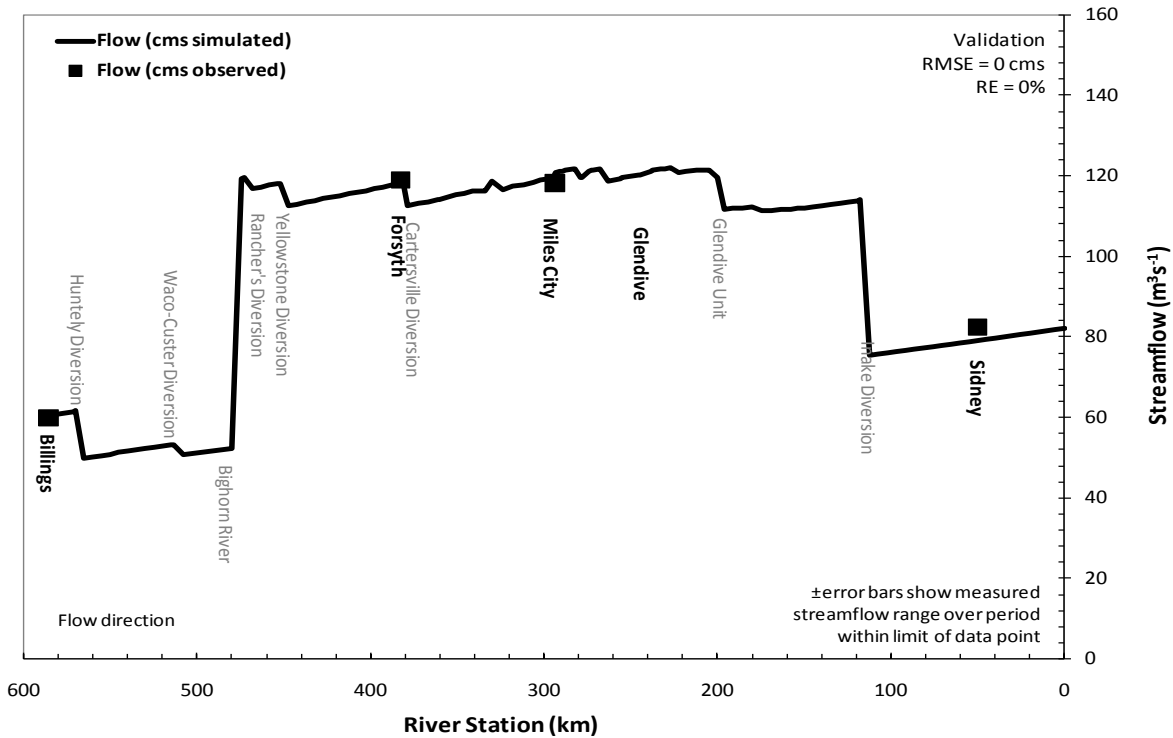

1
2 **Figure 11-1. Simulated and observed streamflow for the Yellowstone River during 2000.**
3

4 **11.3.2 Mass Transport**

5
6 The same mass transport indicators used previously were considered in the USGS validation. In this
7 instance there was no width or depth information available for which to make comparisons. Thus we
8 can only speculate as to the model's reliability. From **Figure 11-2** (top) we can see that the model
9 reasonably reflects the major features of the river (dams, inflows, etc.) and seems to be in good
10 agreement with our 2007 detailed study reach. Prominent features include the six major low-head
11 diversion dams on the river (Huntley, Waco-Custer, Rancher's, Yellowstone, Cartersville, and Intake at
12 km 570, 510, 470, 450, 380, and 120, respectively), the large shifts at the Bighorn River brought about by
13 increases in flow, shallowing and widening at Miles City, and then reductions in width and increases in
14 depth in the lower river.

15
16 Travel-time and reaeration were also assessed for comparative purposes (**Figure 11-2**, bottom). Again,
17 the adjusted travel-time calculator was used to make estimates for the given flow condition (corrected
18 to the dye-study as done previously for the 2007 model). Accordingly, travel time was estimated to be
19 approximately 11 days from Billings to the state-line which is in good agreement with the model.
20 Reaeration also patterns the 2007 model with the highest reaeration rates in the area of the river where
21 velocities are the greatest (due to gradient, km 590-500 and 300-220 km), and then declining in the
22 downstream direction as the river deepens.
23

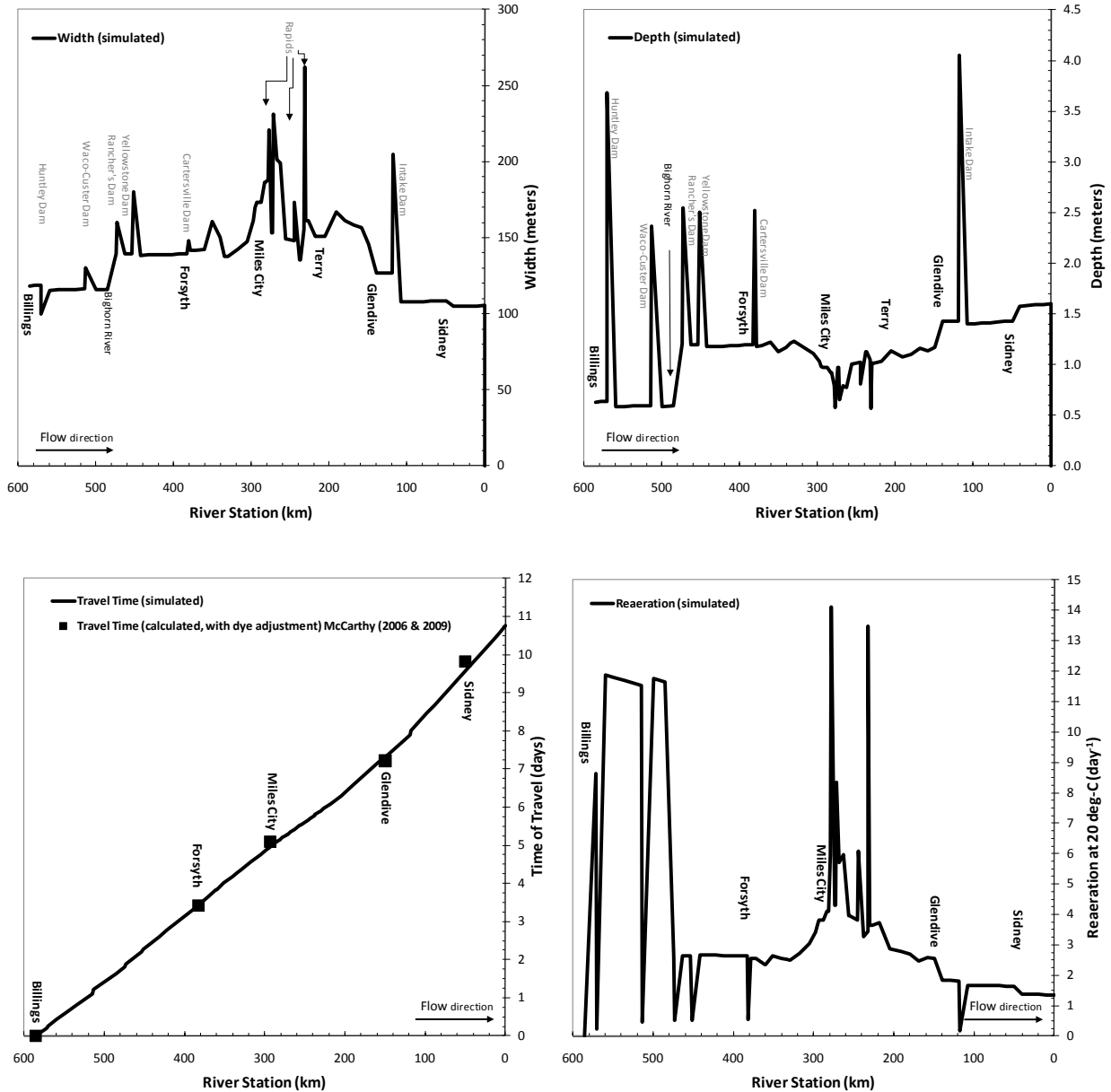

1
2

3
4
5
6

Figure 11-2. Mass transport indicators for the lower Yellowstone River during 2000.
(Top left/right panel). Simulated width and depth. (Bottom left/right panel) Travel-time and reaeration.

11.3.3 Water temperature

8

9 The water temperature simulation performed only marginally for the 2000 validation (**Figure 11-3**, left).
 10 This was at least partially reflective of the way diurnal data was collected by USGS which consisted of
 11 measuring different days at different sites. For example, data was gathered at Billings over the period of
 12 August 23-25, Custer on August, 26-28, Forsyth on August 26-28, Miles City on August 29-30, Terry on
 13 September 13-14, and Sidney on August 28-30. Thus datasets are very short compared to the multi-
 14 week datasets DEQ collected and do not share a single common time period. Consequently, there is no
 15 reason to expect good correlations in temperature. Despite this limitation, the validation was within the

1 ±5% acceptance criteria. RMSE and RE were 1.4°C and -0.2%. Note that Terry was not included in the
 2 statistical analysis as the data was collected two weeks later than the other sites.

3
 4 A diurnal temperature plot of Sidney (e.g., the downstream end of the project reach) is shown in **Figure**
 5 **11-3**, right). It is probably the best of all the diurnal plots and shows that the model adequately reflects
 6 temperature over the course of the day. Differences are most apparent at midday, and it is possible that
 7 this is more a function of the data collection methodology than model error (given the non-typical shape
 8 of the observed data). In either case, the QAPP criteria are met and we feel comfortable believing that
 9 the model is behaving reasonably.

10

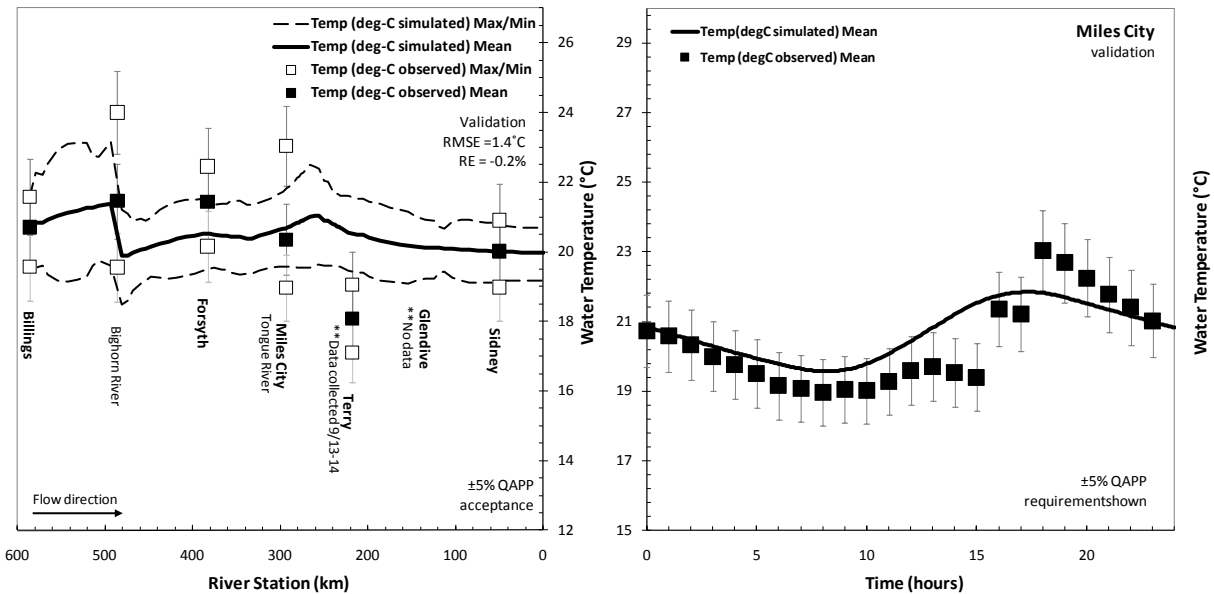

11

12 **Figure 11-3. Temperature simulations for the Yellowstone River during 2000.**

13 (Left panel) Simulated and observed values for the August 2000 validation period. (Right panel) Diurnal simulations
 14 for Sidney.

15

16 11.3.4 Suspended Particles

17

18 Only suspended sediment concentration (SSC) was measured in 2000 and is slightly different than TSS
 19 because the entire sample (not an aliquot of the sample) is filtered in the laboratory and dried and
 20 weighed for analysis. Consequently differences can arise between the two measures, mostly when
 21 heavy particles such as sands are in suspension but are not readily captured in the aliquot. Given the
 22 particle size composition of the Yellowstone River under low-flow conditions (primarily clays as
 23 demonstrated previously), this difference is not a concern and SSC measurements should be very
 24 comparable to TSS measured in 2007¹.

25

¹ It should be noted that TSS is actually a calculated variable in the model. It is computed as the sum of the ash-free dry masses (AFDM, mg L⁻¹) of ISS, detritus, and phytoplankton.

1 Several assumptions were required to partition SSC into appropriate model compartments. The
 2 following relationships were used: $ISS = 0.8 * SSC$, and $detritus = 0.15 * SSC$, which are based on the
 3 ratios obtained during August and September 2007. Applying these in model, the simulations of TSS are
 4 quite good (**Figure 11-4**). RMSE and RE were 2.1 mgD L^{-1} and -7.0% and the plots show similar structure
 5 to that of 2007 with a significant increase after the Powder River. Model output for ISS is shown for
 6 comparative purposes only.

7

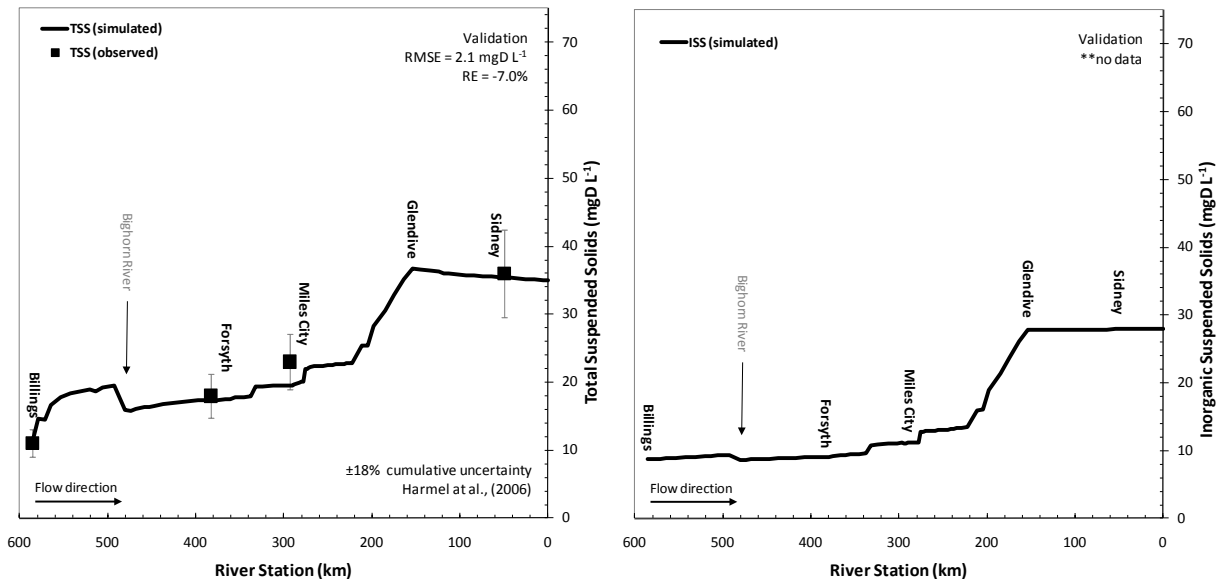

8

9 **Figure 11-4. TSS simulations for the Yellowstone River during 2000.**

10 (Left panel) Observed and simulated TSS. (Right Panel) Same but for ISS (no field data collected).

11

12 11.3.5 Nutrients

13

14 Nutrients were substantially different in 2000 than in 2007. The biggest difference was the deviation
 15 between soluble nitrogen concentrations longitudinally. At Billings (where the Billings WWTP and other
 16 nutrient sources occur) soluble nutrients were quite high whereas they were much lower in the
 17 downstream (below detection).

18

19 11.3.5.1 Nitrogen

20

21 Overall the model did a fair job representing TN in validation (**Figure 11-5**). Concentrations ranged from
 22 300 to $400 \mu\text{g TN L}^{-1}$ (compared to 500 - $600 \mu\text{g L}^{-1}$ in 2007) and RMSE and RE from the simulation were 71
 23 $\mu\text{g L}^{-1}$ and 15.5% . The most significant deviation was near the beginning of the project reach (near
 24 Billings) where the model shows a near instantaneous increase in TN ($\approx 100 \mu\text{g L}^{-1}$). This occurs from algal
 25 uptake of soluble N from the Billings WWTP and subsequent conversion/recycling upon death. Clearly,
 26 the rate at which this is occurring in the model is too fast. More of the N should be bound in the algae
 27 instead of recycling through death [i.e., algal death rates need to be much lower (near zero) to reach
 28 biomasses approaching those observed at Billings ($\approx 800 \text{ mgChla m}^{-2}$, *Cladophora* streamers)]. Hence the
 29 model does not reflect *Cladophora* growth accurately, especially recalling our analysis of unlimited
 30 growth conditions as described in **Section 9.5**.

31

1 To accommodate this deficiency and evaluate the other calibrated rate transformations in the model,
 2 the algal death rate at Billings was altered using reach specific rates which considerably improved the TN
 3 simulation by decreasing the amount of OrgN generated from algal death. We can therefore reasonably
 4 conclude first that other N-related rates in the model are satisfactory (hydrolysis, nitrification, etc.), and
 5 also that the model is perhaps not appropriate in the Billings region where there are ample nutrients
 6 and light, algae are in a better physiological condition, and *Cladophora* growth is luxuriant.
 7

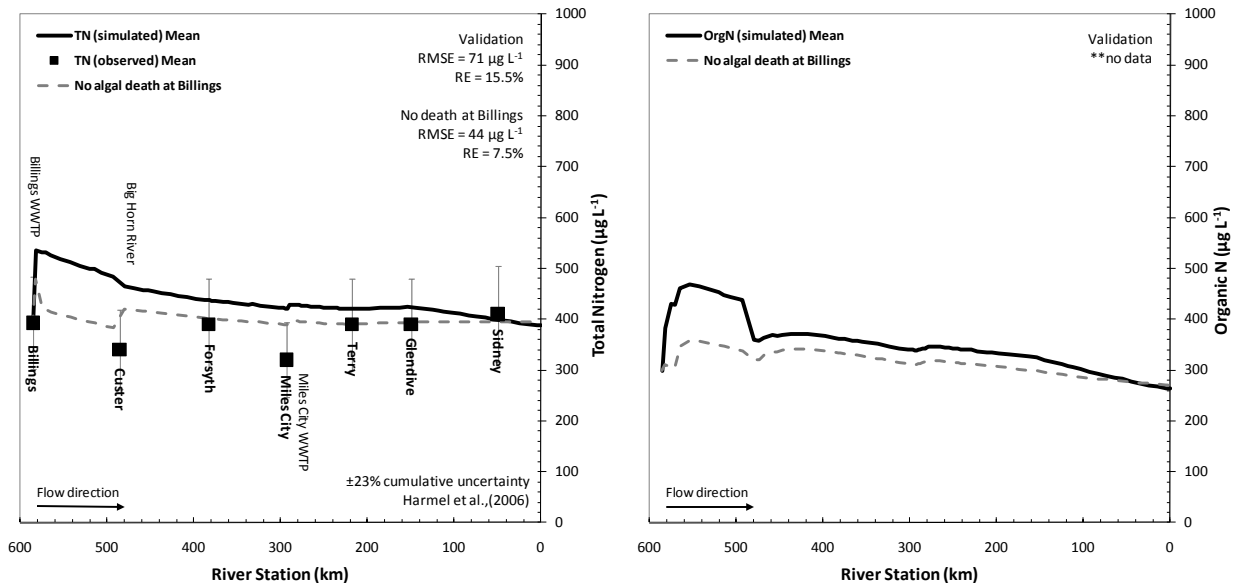

8
 9 **Figure 11-5. Total and organic N simulations for the Yellowstone River during August 2000.**

10 (Left panel). Observed and simulated total nitrogen. (Right panel) Same but for organic nitrogen (for reference
 11 purposes only, no data collected).

12
 13 The remaining N data (NO_3^- and NH_4^-) were non-detect and only allow qualitative comparisons.
 14 Graphical plots tend to show interesting trends over the length of the study reach (**Figure 11-6**), for
 15 example we see that high NO_3^- concentrations occur near Billings (both up- and down-stream of the
 16 WWTP), below the Bighorn River, and below the Miles City WWTP. Similar increases are evident for NH_4^- ,
 17 though not as exaggerated. The locations generally correlate to areas of highest productivity (as shown
 18 later in this section). Since the model is generally following this same trend as the data, we can
 19 qualitatively conclude that simulations are sufficient. Quantitative data are necessary to definitively
 20 make this determination.

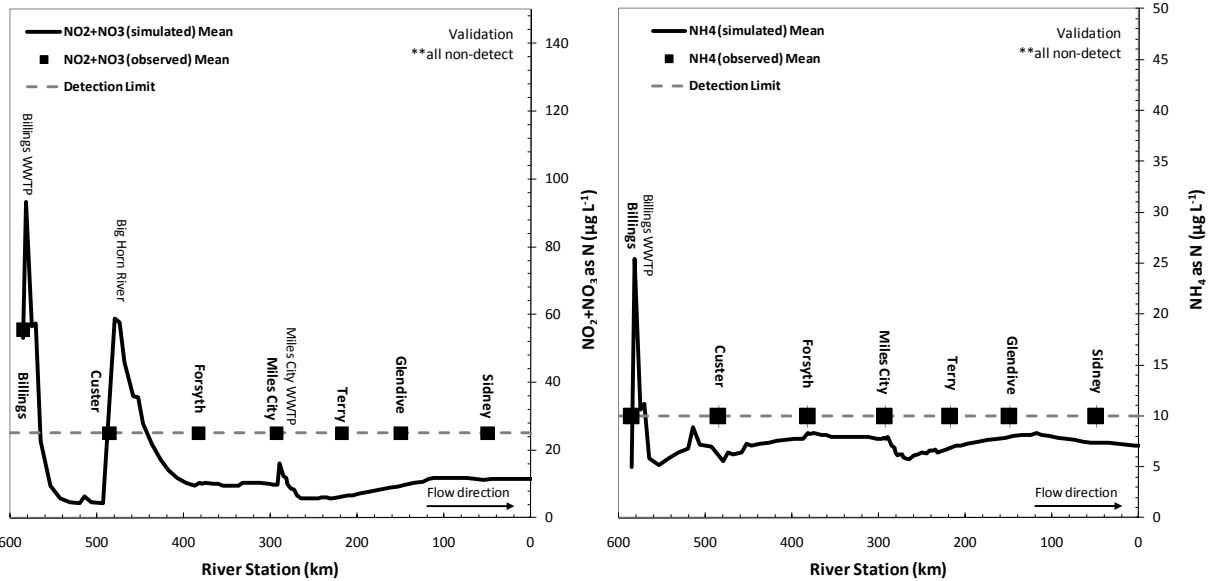

1
2 **Figure 11-6. Nitrogen simulations for the Yellowstone River during August 2000.**
3 (Left panel). Simulated and observed nitrate. (Right panel) Same but for ammonia. Both of the soluble N plot data
4 are below the detection limits referenced by the dotted line.

6 11.3.5.2 Phosphorus

7
8 Phosphorus follows a similar pattern to nitrogen with a clear and consistent TP profile characteristic of
9 increased levels near Billings from the Billings WWTP plant, declines at the Bighorn River due to dilution,
10 and then increases downstream of the Powder River (**Figure 11-7**, Left panel) (recall that accretion of ISS
11 below the Powder River also includes OrgP from P sorption). RMSE and RE were $5 \mu\text{g L}^{-1}$ and -11.7% for
12 TP, and overall, concentrations ranged from $25\text{--}50 \mu\text{g L}^{-1}$. TP was less affected by the algal conditions
13 described previously for nitrogen due to a lower stoichiometric order.

14
15 From **Figure 11-7**, Right panel, SRP could not be characterized due to the fact that it was below
16 detection at all locations. It appears to be most influenced by the Billings WWTP (which caused a
17 quadrupling in concentration), and then from dilution by the Big Horn River and loadings from the Miles
18 City WWTP. The model generally underestimated the decline of SRP downstream of Billings as P
19 depletion had not occurred to appropriate levels before arriving at Custer. This is somewhat masked in
20 the results due to the Big Horn River inflow which occurs directly downstream of Custer. Thus P uptake
21 may be understated in the model. In the lower reaches, SRP levels remain quite low, similar to
22 concentrations observed in 2007, and seems to track quite well. By default this means that our model
23 may be better tuned to lower SRP concentrations than those approaching the order of magnitude
24 observed in the Billings region.
25

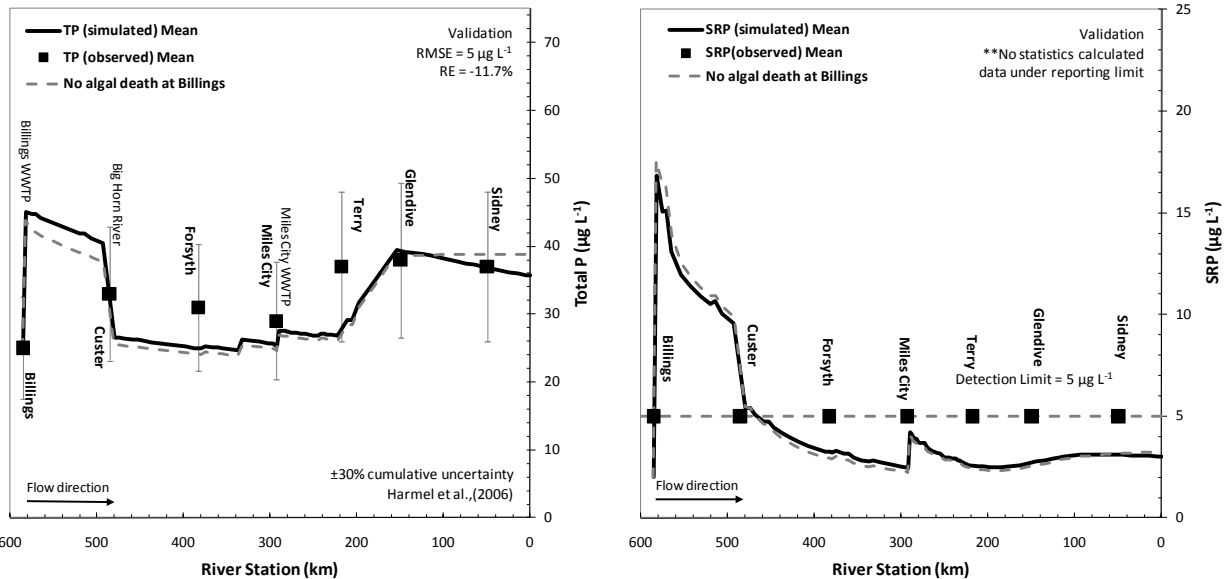

1
2 **Figure 11-7. Phosphorus simulation for the Yellowstone River during August 2000.**
3 (Left panel). Simulated and observed total phosphorus. (Right panel) Same but for SRP. Note that the USGS
4 observation site at Billings is directly upstream of the WWTP. Thus the large SRP actually occurs downstream of the
5 monitoring location.

6 7 **11.3.5.3 Nutrient Limitation**

8
9 As in the 2007 work, nutrient limitation factors were evaluated for the 2000 condition model. The
10 profile is particularly interesting and shows a variety of shifts in the limiting nutrient for benthic algae
11 (**Figure 11-8**, Left panel). Bottom algae switch limitation very quickly based on shifts in ambient
12 concentrations and alternate between P and N limitation successively. Light limitation for benthic algae
13 is also very interesting. Three distinct regions of light occur longitudinally: (1) the region upstream of the
14 Bighorn River (limitation factor of ≈ 0.9), (2) the Bighorn River to Powder River (limitation factor of ≈ 0.5),
15 and (3) Powder River to State line (limitation factor of ≈ 0.1). Given this consideration, our decision to
16 break the river into different distinct nutrient criteria assessment units was a good decision (see **Section**
17 **4.4**). The most downstream region (Powder River to state-line) is highly light limited. Hence it is
18 apparent why a shift from benthic algae to phytoplankton dominance has occurred.

19
20 For phytoplankton things are less clear and the state of nutrient limitation is most dependent on the
21 initial conditions of the model. Since no C:N:P data were collected during 2000, we had to use the data
22 from 2007. In 2007, they were N limited which by default forced us to assume that phytoplankton were
23 N limited in 2000. We have no way to verify this assumption, but based on the similarity of both N and P
24 limitation factors (**Figure 11-8**, Right panel, $\approx 0.8-0.9$), there would be very little difference in the
25 simulation switched to P limitation (only a reduction in growth rate of ≈ 0.1 would occur).
26

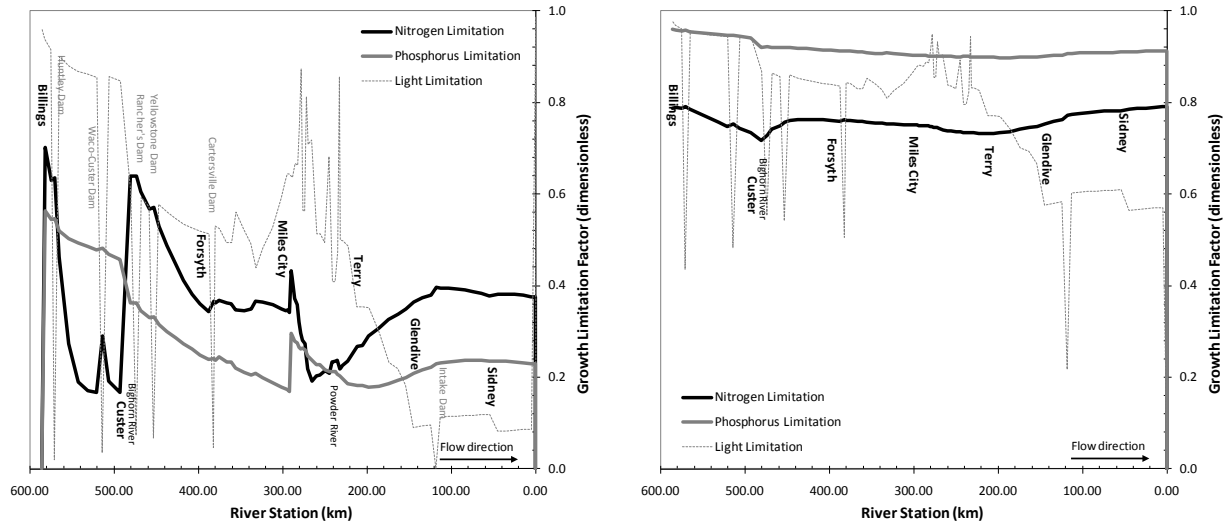

1
2 **Figure 11-8. Nutrient and light limitation factors for the Yellowstone River during 2000.**

3 (Left panel) Nutrient and light limitation factors for benthic algae. (Right panel) Same but for phytoplankton. The
4 effect of the diversion dams are apparent on both benthic algae and phytoplankton as they increase the river
5 depth and cause strong light limitation.
6

7 **11.3.6 Algae**

8
9 Both benthic algae and phytoplankton were considered as part of the cross-validation. As identified in
10 **Section 10.0**, benthic algae are sensitive to element depth in Q2K and unfortunately USGS did not
11 acquire this data during 2000. Nor was their collection methodology similar to ours either¹. As a result,
12 we were not able to make direct statistical comparisons between Q2K benthic output and the USGS
13 data. Qualitative comparisons are shown in **Figure 11-9** (Left panel). Given that USGS data are collected
14 in the richest targeted habitat (see footnote), we expected somewhat higher field biomasses than
15 output by Q2K. This was not the case though as the model over-simulated on five out of seven of the
16 data points. In general, the trend was under-simulation of large biomasses and over-simulation of
17 smaller densities. The overall gradient is reflected in the model however.
18

19 Phytoplankton simulations are shown in **Figure 11-9** (Right panel). They were within the expected
20 variation of phytoplankton (Hakanson, et al., 2003) and were not significantly different than the
21 calibration values, with RMSE of $1.8 \mu\text{g L}^{-1}$ and RE of +18.5%. The RE is slightly outside the recommended
22 values for the project QAPP, and we slightly overestimated phytoplankton. Simulations are well within
23 the recommended range reported by others however (**Table 8-1**). Deviation could be due to a number

¹ The USGS collections were completed using the National Water Quality Assessment (NAWQA) protocol (personal communication, D. Peterson). In this method, emphasis is placed on acquiring data from the richest targeted habitat (RTH), which for the Yellowstone River, was riffles. As a result, data was collected primarily from shallow regions. Additionally, the data were collected only at five different locations at each site. This was done by scraping algae at five separate locations in a wadeable riffle (maximum of 1,000 m reach length) and then compositing these samples together for analysis.

1 of reasons including slightly different growth rates between 2000 and 2007 (different species or
 2 conditions), problems with the temperature simulation, or perhaps differences in available light
 3 (referring back to the suspended particles discussion previously). In any case, the simulations achieved
 4 results that typify the literature and are acceptable to DEQ.
 5

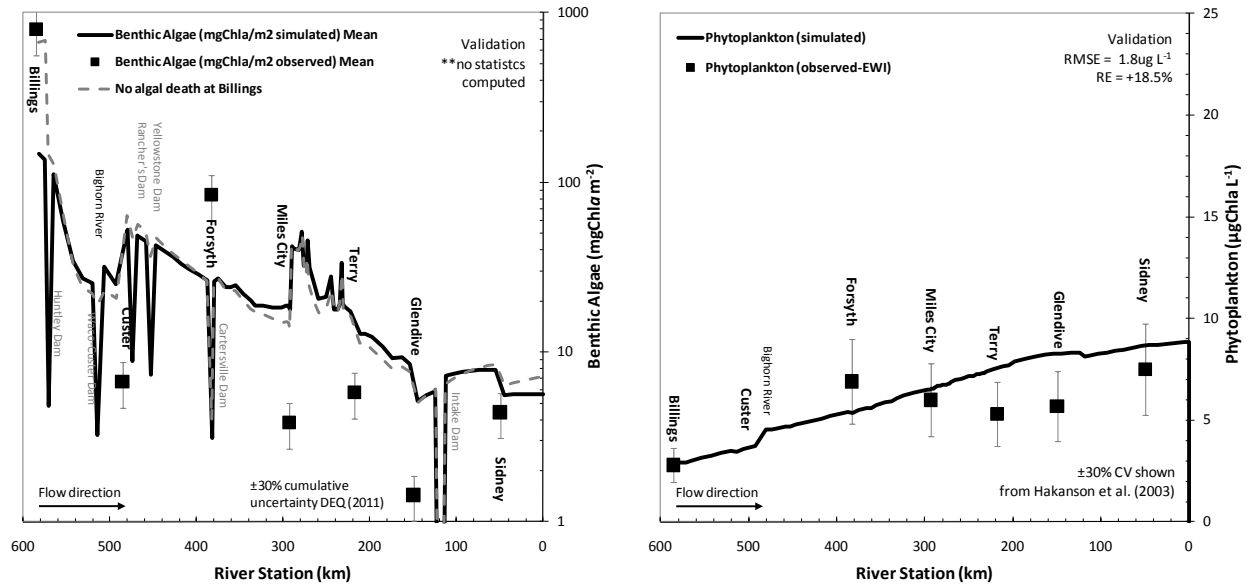

6
 7 **Figure 11-9. Algal simulations for the Yellowstone River during August 2000.**
 8 (Left panel) Simulated and observed benthic algae. (Right panel) Same but for phytoplankton.
 9

10 11.3.7 Oxygen

11
 12 The dissolved oxygen simulation is shown in **Figure 11-10** (Left panel). Overall, we met the QAPP
 13 requirement with RMSE of $+0.36 \text{ mg L}^{-1}$ and RE of 1.8%. This suggests that the model performs
 14 adequately in simulating river productivity in two low-flow situations (2000 and 2007). Very large diurnal
 15 DO swings were identified in the Billings region (km 590, 10 mg L^{-1} daily flux) then the river declines in
 16 production steadily downstream. The exception is near Miles City (km 580) where wastewater
 17 contributions drive productivity back upward for a short period (similar as to seen in 2007). The impact
 18 of the low-head dams is also observed pushing the DO minimum and maximum towards saturation.
 19

20 There one difficulty in the DO simulation was near Forsyth (km 390). Maximum observed DO at this site
 21 barely reached saturation levels which is unlikely given the rest of the river profile. Consequently, there
 22 was either a problem with the observed data, or a large DO sink (either SOD or CBOD) that we missed¹.
 23 Given the discontinuity in the temperature data (shown previously), and from incidental analysis in the

¹ The Bighorn River enters near this location which could possibly be a source of dead/decaying algae. A CBOD source was already specified for the Bighorn ($\approx 10 \text{ mg L}^{-1}$) though, which was based on calibration of CBOD (no data were collected in 2000). Historical measurements show very high dissolved organic carbon concentrations can occur.

1 model, we concluded that it was most likely due to the instrumentation placement at Forsyth (i.e., it was
 2 not representative of the river). Consequently, that particular data site was omitted.

3

4 The diurnal simulations were also quite reasonable. An example for one site, Miles City, is shown in
 5 **Figure 11-10** (Right panel). Productivity was at its highest near solar noon and varied consistently with
 6 sunrise and sunset. The model tended to over-simulate temperatures throughout the day at this
 7 location. Other sites had better agreement as can be seen in the longitudinal plot.

8

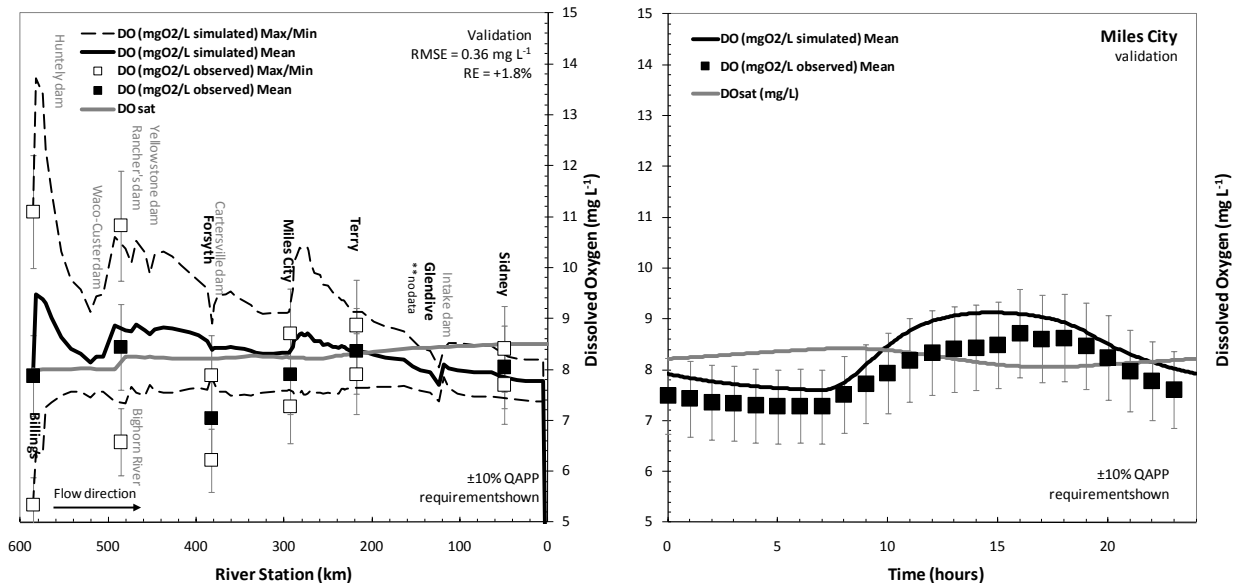

9

10 **Figure 11-10. Dissolved oxygen simulations for the Yellowstone River during August 2000.**

11 (Left panel) Simulated and observed DO. (Right panel) Diurnal DO simulations for Miles City.

12

13 11.3.8 Carbon

14

15 Carbon related variables such as pH, alkalinity, and TOC are shown in **Figure 11-11**. Discussion about
 16 each are presented in the following sections.

17

18 11.2.8.1 pH and Alkalinity

19

20 Longitudinal simulations of pH (**Figure 11-1**, Top left panel) are fairly good and had RMSE of 0.07 pH
 21 units and RE of -0.2%. Overall pH correlated well with other productivity-related variables such as DO
 22 and benthic algae and showed the widest diurnal variability in the Billings region due to high nutrient
 23 levels and algal growth. There was then a consistent decline in flux downstream short of a small increase
 24 is in the vicinity of the Miles City WWTP additions (km 250). Diurnal pH was hard to discern due to the
 25 multi-day collection method by the USGS but a plot for Miles City is shown in **Figure 11-11** (Top right
 26 panel). Alkalinity is shown in **Figure 11-11** (Bottom left panel). Very little data was available to evaluate
 27 the simulation, but it happens to be reasonable with RMSE and RE of 2.9 mg CaCO₃L⁻¹ and -0.9%.

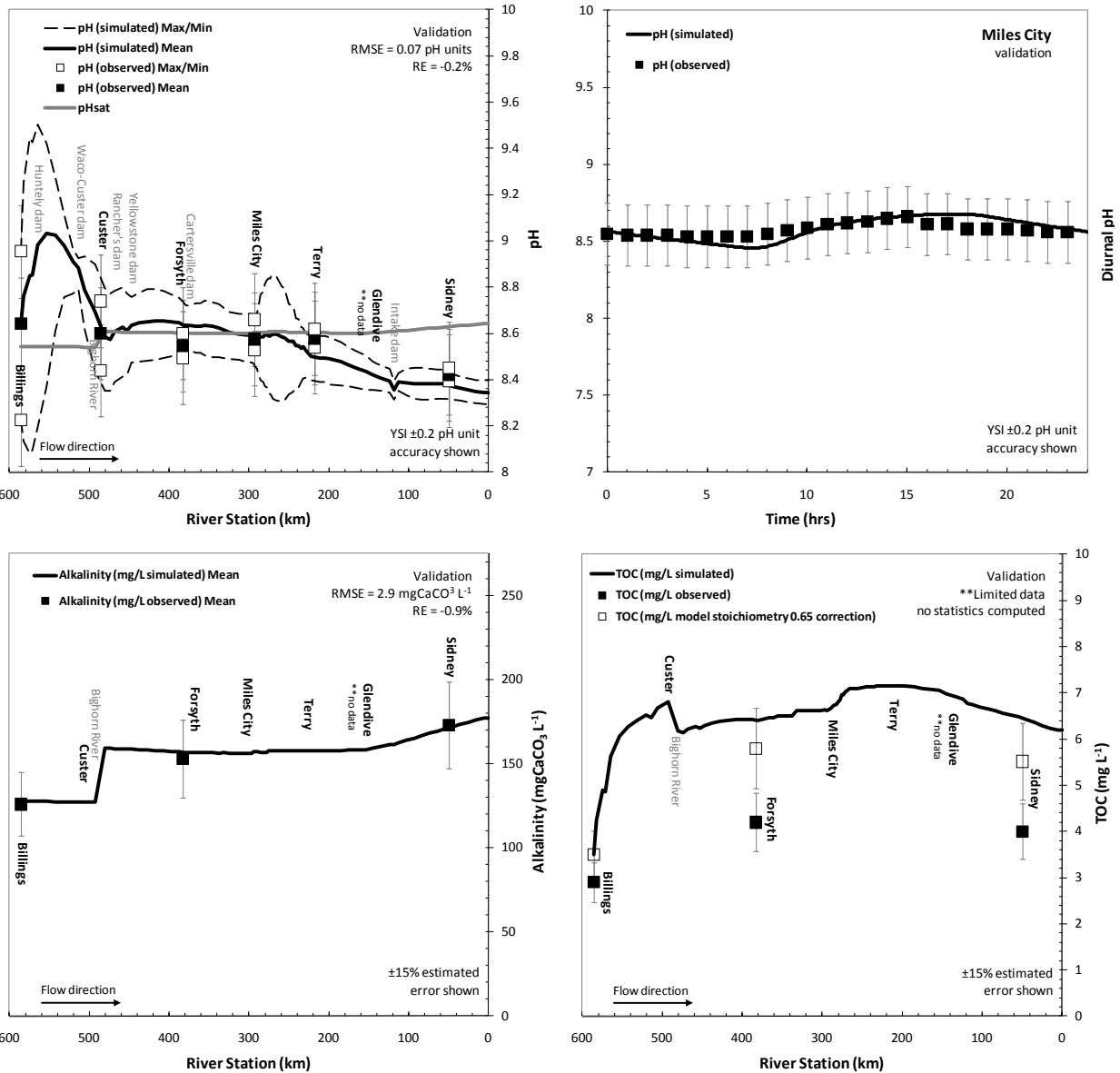

1

2

3

Figure 11-11. pH, alkalinity, and TOC simulations for the Yellowstone River during 2000.

4

(Top left/right panel) Simulated and observed longitudinal pH and diurnal pH simulation for Miles City. (Bottom left/right panel) Simulated and observed alkalinity and total organic carbon (TOC, as detailed in the next section).

5

6

7

11.3.8.2 CBOD and TOC

8

9

10

11

12

13

14

15

There was very little information to make CBOD or TOC comparisons. In 2000, only three sites (Billings, Forsyth, and Glendive) had carbon-related variables measured. These included dissolved and particulate organic carbon (USGS pcode 681 and 689) that together sum to form TOC. Comparisons of TOC are presented in **Figure 11-11** (Bottom right panel) with the caveats identified previously in **Section 10.5.5** (regarding the fact that TOC is a calculated variable in the model stoichiometry and other stoichiometric issues related to the inflation of carbon from detritus).

11.3.9 Conductivity

Similar to the previous section, conductivity was used as a final estimate of model validity. The conductivity simulation for the river is shown in **Figure 11-12** and is very reasonable. The only major change occurred at the Bighorn River.

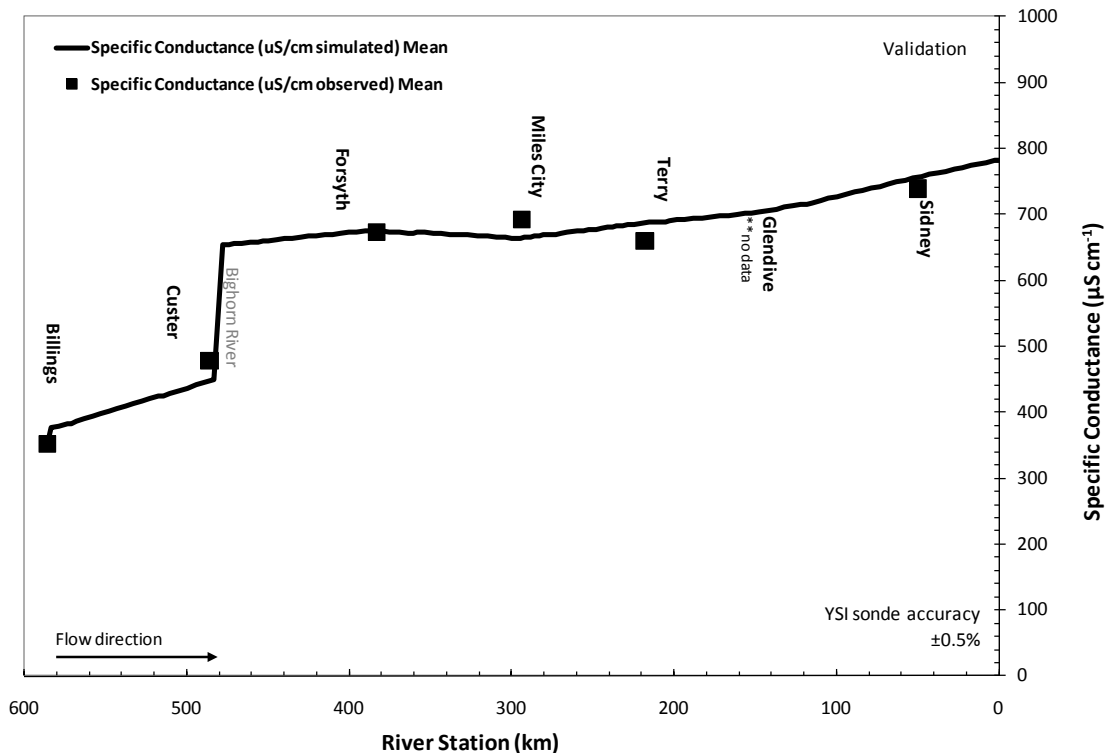

Figure 11-12. Simulated and observed conductivity for the Yellowstone River during 2000.

11.4 Some Final Thoughts on the Model

Based on this second evaluation (i.e., the cross-validation), we conclude that the Q2K model of the Yellowstone River meets the acceptance criteria specified in the project QAPP, in addition to outside recommendations from the literature. As such, the model is valid for use for nutrient criteria development. However some caveats do apply, specifically in regard to the time-period that the model is appropriate for representing.

Given the conditioning detailed in previous section (i.e., calibration and validation to a period where river productivity is near its peak and during low-flow) we feel that the model is only valid to those circumstances encountered in model development. Thus it should not be applied, in particular, to high-flows (we did not apply or test the model against high flow conditions), late-season fall condition where algal growth is beginning to senesce (such as observed in our September data), or any other condition atypical to those described previously. It could perhaps be expanded slightly to include any other period when the river has settled into a state of hydrologic stability during warm weather.

12.0 CRITICAL LOW-FLOW DESIGN CONDITIONS FOR NUTRIENT CRITERIA

Critical low-flow conditions and the design climate for criteria development are described in this section. The logic behind this information and supporting details are found in the following sections.

12.1 Design Flows for Water Quality Modeling Studies

DEQ currently uses a seven-day, ten-year design flow (7Q10) to establish Montana Pollutant Discharge Elimination System (MPDES) permits. Dilution requirements for this critical low-flow require that existing water quality standards, including those linked to nutrients (i.e., benthic algae, dissolved oxygen, or diurnal pH variations) are not violated (ARM 17.30.635). Such designations are common in water quality practice and are used by most states. Recommendations largely stem from a single source, *“Technical Guidance for Performing Wasteload Allocations, Book VI, Design Conditions, Chapter 1 Stream Design Flow for Steady-State Modeling”* (EPA, 1986b).

The 7Q10 originated in toxics. The “7” reflects the flow duration over which the concentration in question is averaged and the “10” reflects the frequency of allowable excursions from the criterion (i.e., once every 10 years). In theory, allowable excursions are uncommon enough to allow the aquatic community to recover in the interim years. Designation of the 7Q10 has a long history. In fact, the 7Q10 was really only an interim recommendation from EPA (U.S. Environmental Protection Agency, 1985). Preference for site-specific, biologically-driven approaches were initially given based on criteria continuous concentrations (CCC). The CCC is the highest concentration of a pollutant to which aquatic life can be exposed for an extended period of time (4 days) without deleterious effects (chronic). The intent is that a 4-day mean concentration should not exceed the CCC, but if it did, it should not occur more than once every 3 years, to allow sufficient recovery time.

The use of a dynamic model to predict the number and extent of events exceeding the CCC is recommended by EPA (1985), with the understanding that data requirements and model complexity make this approach limited. As such, they offered the 7Q10 as an approximate surrogate for the 4-day/3 year biological approach through comparison of the hydrologically-based 7Q10 and biologically-based 4-day/3 year approach for a set of 60 rivers in the U.S. (U.S. Environmental Protection Agency, 1991). It was concluded that the relation between the two approaches was variable, but that generally the hydrologically-based approach was suitable although it allowed somewhat more excursions than desired (U.S. Environmental Protection Agency, 1991).

Nevertheless, both approaches continue to be recommended by EPA and Montana currently uses the hydrologically-based approach (ARM 17.30.635). Given auspices that the 7Q10 is perhaps not applicable to nutrients, we further explored design flows for nutrients as directed in ARM 17.30.635(4). Specifically this rule states that “The Department shall determine the acceptable stream flow for disposal system design for controlling nitrogen and phosphorus concentrations”. We explored a number of alternative design conditions as a consequence.

12.2 Identifying an Appropriate Design Flow Duration

Methods to identify design flow durations for large rivers are detailed in the following sections.

12.2.1 Algal Growth as an Indicator of Time to Nuisance Biomass

Algal growth rates govern the time required to reach nuisance biomass and are the predecessor to all attendant eutrophication responses. Hence we used them as a way to establish design flow durations for nutrient control on large rivers. The decision was based on a number of factors including their direct relevance to eutrophication, the fact that they are well reported in the literature, and that they are easily measured. Our position is that the design flow should be protective of water quality over the same duration that it takes that waterbody to reach an adverse response from nutrient loadings.

To help conceptualize this understanding, DEQ considered work by Stevenson, et al. (1996). They defined key points of peak biomass (PB) and time to peak biomass (T_{PB}) on a typical benthic algal biomass accrual and decline curve (**Figure 12-1**). This curve is characteristic of colonization, exponential growth, and autogenic sloughing and loss. We defined a point of interest in the accrual phase called nuisance biomass (NB) and time to nuisance biomass (T_{NB}) which occurs somewhere between initial colonization and PB. For any effective nutrient control strategy, algal biomass must be less than or equal to NB to restrict nuisance growth and meet water quality standards and hence by default NB would be equal to PB. For our purpose we define nuisance levels as those identified in Suplee, et al., (2009).

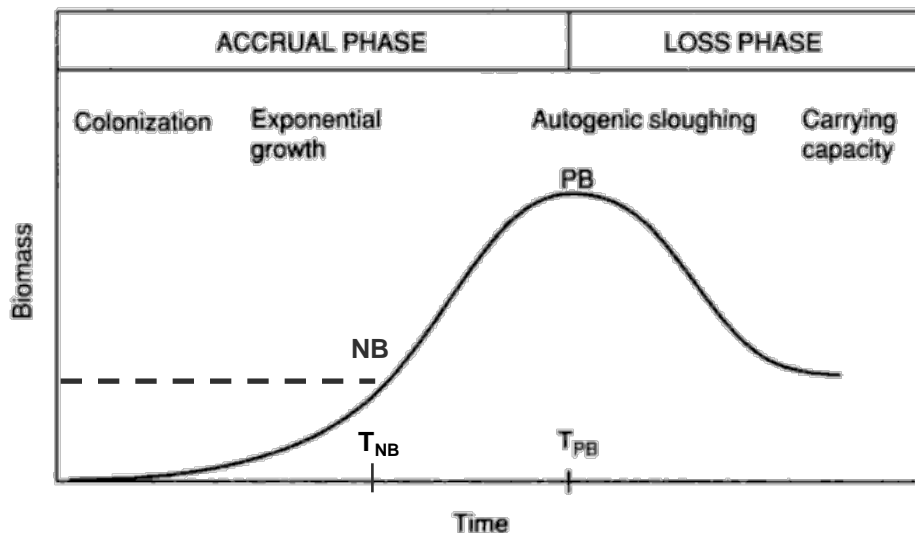

Figure 12-1. Idealized benthic algae growth curve.

Reproduced from Stevenson, et al. (1996). Modified to include nuisance conditions. NB = nuisance biomass, T_{NB} = time to nuisance algae, PB=peak biomass, T_{PB} =time to PB from colonization.

The accrual portion of the growth curve described previously can be modeled using an exponential growth equation (**Equation 12-1**) with space limitation (**Equation 12-2**) as shown in Chapra, et al., (2008), where $Chla$ = biomass at day t (mgChla m^{-2}), a_b = initial biomass (mgChla m^{-2}), k = the growth rate (day^{-1}), t = time (days), ϕ_{Sb} = a space limitation factor (dimensionless), and $a_{b,\text{max}}$ = maximum carrying capacity of biomass (mgChla m^{-2}). Given a known relative specific growth rate (i.e., measured in either the field or the laboratory) and maximum carrying capacity [which is also well characterized in the literature, (Horner, et al., 1983)], T_{NB} , PB , and T_{PB} can all be readily estimated.

1 **(Equation 12-1)**
$$Chla = a_b \times \exp^{kt}$$

2

3 **(Equation 12-2)**
$$\phi_{Sb} = 1 - \frac{a_b}{a_{b,max}}$$

4

5 The equations above can subsequently be used to describe algal growth kinetics as detailed in the next
6 section.

7

8 **12.2.2 Enrichment Studies Detailing Algal Growth Kinetics**

9

10 To estimate a plausible timeframe to reach nuisance conditions in large rivers, we compiled as many
11 field studies as we could that had time-variable algal biomass measurements in response to nutrient
12 enrichment. Previous work (Horner, et al., 1983; Stevenson, et al., 1996) shows that peak biomasses can
13 be achieved in as little as two weeks, or as long as two months, depending on relative specific growth
14 rates. Hence the time to nuisance biomass is likely quite variable and system specific. The magnitude of
15 P_B is also believed to vary, and ranges from 300-400 mg m⁻² Chla for diatoms (Bothwell, 1989), to >1,200
16 mg m⁻² Chla for filamentous algae like *Cladophora* (Stevenson, et al., 1996).

17

18 While the methodologies of identified studies vary, those with reliable and reproducible indicators of
19 relative algal growth rates (and multiple algal collections over time) were of primary interest. Those
20 found to be conducted under moderate enrichment conditions, similar to our modeled nutrient-addition
21 scenarios described later, were of most importance. And only published studies with water temperature
22 data were included so that we could make corrections to standard reference temperature (20°C). Those
23 identified that met the specified criteria are shown in **Table 12-1**.

24

25 **Table 12-1. Enrichment studies and associated growth rates adjusted to 20 degrees C.**

26 Growth rates are corrected to the reference temperature using the Arrhenius equation.

Algae Type	Net Specific Growth Rate at 20°C (k, day ⁻¹)	Reference	Location	Comment
Diatoms	0.50	Klarich (1977)	Yellowstone River, MT	Near Huntley Billings WWTP
Diatoms	0.55	Bothwell and Stockner (1980)	McKenzie River, OR	5% kraft mill effluent
Cladophora	0.71	Auer and Canale (1982b)	Lake Huron, MI	Harbor Beach WWTP
Green algae	0.52	Horner et al. (1983)	Lab Flume	Laboratory N & P addition
Diatoms	0.42	Bothwell (1985)	Thompson River, BC	Downstream of WWTP
Diatoms	0.62	Bothwell (1988)	S. Thompson River, BC	Flume with N & P addition
Diatoms	0.58	Biggs (1990)	South Brook, New Zealand	Downstream of WWTP
Diatoms	0.45	Stevenson (1990)	Wilson Creek, KY	Agricul. stream after spate

27

- 1 Adjusted growth coefficients (k , day^{-1}) are very consistent and have a mean of $0.55 \pm 0.09 \text{ day}^{-1}$ (95%
 2 confidence level). When applied to **Equation 12-1** and **Equation 12-2**, they suggest that T_{NB} would be on
 3 average $14 \pm$ approximately 3 days under enriched conditions¹ (**Figure 12-2**).

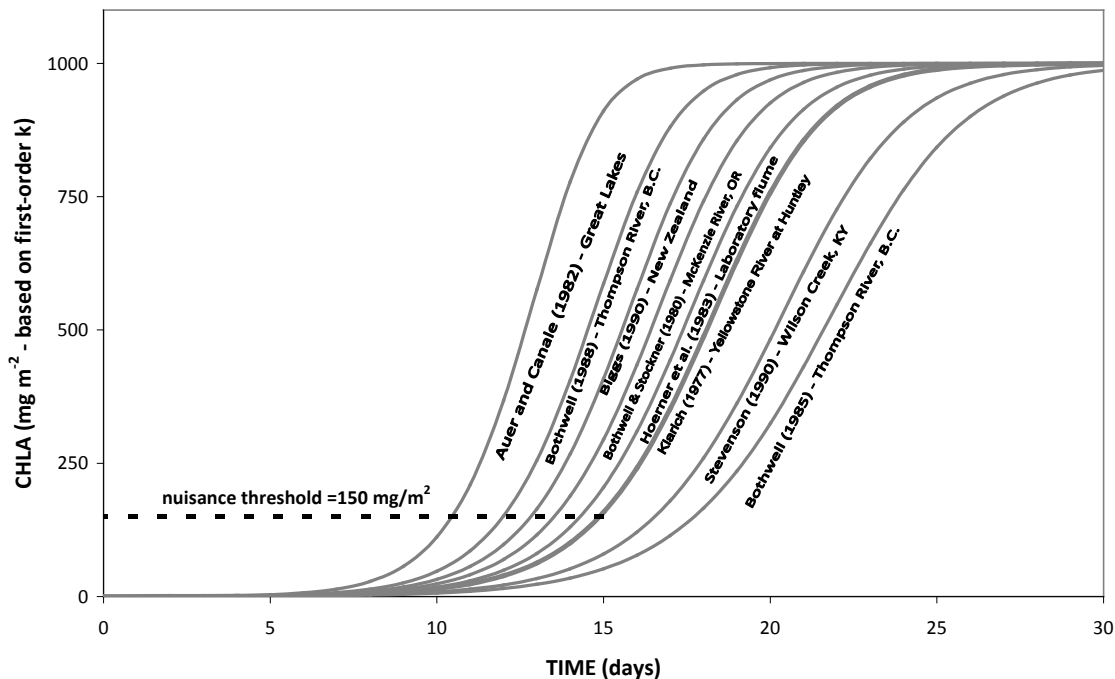

- 4
 5 **Figure 12-2. Estimated time to nuisance algal biomass under moderately enriched conditions.**
 6 Each curve was generated using the k value reported in **Table 12-2**. To be consistent with the study completed on
 7 the Yellowstone river by Klarich (1977)², an estimate of 15 days was believed to be an appropriate design flow
 8 duration estimate by DEQ. It was within the margin of error of the original estimate of all studies (± 3 days).
 9

10 12.2.3 Justification of Time to Nuisance Algae Estimate

- 11
 12 The time to nuisance biomass estimate described previously is not without its problems and warrants a
 13 discussion. The most uncertain part of the estimate is whether the algal growth rates identified in the
 14 literature are suitable for criteria development for the Yellowstone River. If proposed criteria induces a
 15 lower level of enrichment than detailed in the literature, a reduction in relative growth rate would be
 16 expected. This would extend the time to nuisance biomass and lengthen the associated design-flow
 17 duration. The general consensus from the literature and site-specific data from both the Yellowstone

¹ An initial biomass of 0.1 mg m^{-2} Chl a was assumed in all calculations. Times to nuisance biomass range from approximately 11-17 days based on the studies evaluated.

² This Klarich (1977) work was completed in the Billings area (Huntley site downstream of Billings) using diatometers, which are glass slides placed in the river over a specified period of time. The most productive of all locations was downstream of the Billings WWTP, hence it was believed to be a good estimator or algal growth rates under enriched conditions.

1 River and another study in Montana¹ caused us to gravitate to a 15-day duration design
2 flow. Consequently we believe our estimates are justified and reasonable. One could perhaps argue that
3 this estimate is artificially fast given we cannot characterize the extent of the enrichment and clearly PB
4 approaches equality with NB as growth rates reduce. A counterpoint would be that our initial starting
5 biomasses used in constructing the growth curve ($0.1 \text{ mg m}^{-2} \text{ Chl}a$) were too low (i.e., probable standing
6 crops of algae in late summer would be more like $5\text{-}40 \text{ mg Chl}a \text{ m}^{-2}$) which seemingly counters the
7 previous argument. Taken together, this leads us to believe that 15 days to NB is a reasonable amount
8 of elapsed time.

9
10 Finally, it should be mentioned that this idealized growth curve doesn't really exist. Rather, some
11 approximate form of it occurs, in which the growth rate is continually adjusting to the varying
12 continuum of light, temperature, and nutrients over time. Consequently, algal biomasses once
13 established may have more to do with prior river conditions (e.g., a result of luxury uptake of nutrients),
14 than conditions observed at the exact time of monitoring. We have selected a time of stable conditions
15 for criteria development to hopefully minimize this disconnect, reflecting a period of optimal growth
16 (warm temperature, stable flows, good light conditions, etc.).

18 **12.3 Low-flow Frequency Analysis**

19
20 We conducted a low-flow frequency analysis using the 15-day duration determined previously. A 10-
21 year recurrence interval was used to remain consistent with past design flow precedent which means
22 that no more than one exceedence period will occur on average every 10 years. Such data are typically
23 published by USGS as part of their scientific investigations reports, however, the most recent update for
24 Montana is current only through 2002 (McCarthy, 2004). It also does not include a 15-Day 10-Year Low-
25 flow Condition (15Q10) seasonal probability of low flow. This warranted the update by DEQ as
26 described in the rest of this section. It should be noted that our work here is not an annual low-flow
27 analysis, but rather a seasonal low-flow analysis over the period of July 1 – September 30 (to coincide
28 with the annual limiting period).

29
30 We completed the *n*-day (15) low-flow frequency analysis using the USGS Surface Water Statistics
31 (SWSTAT) software (Lumb, et al., 1993). This method is identical to that used by USGS (P. McCarthy,
32 personal communication). Given the relatively short period of record at Forsyth and Glendive, MT (1978-
33 current and 2003-current, respectively), statistical analysis was completed only for Miles City. Also, the
34 period of analysis was constrained to the regulated streamflow period of 1968-2008 to be consistent
35 with prior low-flow work done by USGS (i.e., to account for flow regulation following the construction of
36 Yellowtail Dam on the Bighorn River, personal communication, P. McCarthy). The time-series used in the

¹ This was a recent stream nutrient addition study completed by DEQ on a similarly turbid waterbody in eastern Montana (DEQ, 2010). In this work, peak algal biomass clearly occurred 20 days after N and P dosing began (peaked at $1,092 \text{ mg Chl}a \text{ m}^{-2}$) and was documented by photo series and by measurement of benthic Chl a several times. The biomass peak was filamentous algae, not diatoms. Mean stream water temperature over the time period was 21.8°C (16.2°C min., 28.9°C max.), very close to our reference temperature of 20°C .

1 low-flow analysis is shown in **Figure 12-3**. Daily time-series from NWIS were formatted into watershed
 2 data management files (WDM) for the analysis and
 3

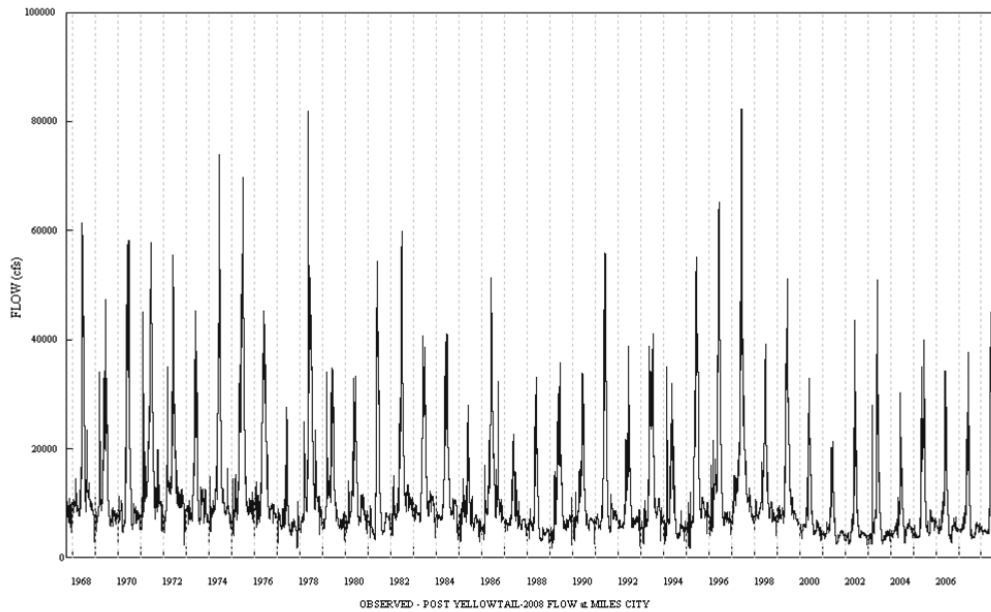

4 **Figure 12-3. Period of record used in development of low-flow frequency curves for Miles City.**

6 **12.3.1 Seasonal n -day Low-flow Analysis (1968-2009)**

7
 8
 9 The seasonal n -day low-flow analysis was done over the period of July 1 – September 30 to be consistent
 10 with the growing season defined in Suplee, et al. (2007). When completing n -day averaging over
 11 seasonal periods, daily streamflow values (Q) are evaluated over a window of n days (15 in our
 12 application) from the beginning of the season to the end of the season (**Equation 11-3**), where $nday_{min}$ =
 13 the seasonal low flow, Q_{begin} = mean daily flow at the beginning of the averaging season, n = the number
 14 of averaging days in the analysis (15 in our example again), and Q_{end} is mean daily flow at the end of the
 15 season. The minimum of all the n -day averages becomes the n -day low-flow for that season. This is
 16 completed over multiple years, and then each year's seasonal minimum is used in ranking and
 17 probability plotting.
 18

19 **(Equation 12-3)**
$$nday_{min} = \min \left[\frac{\sum_{Q_{begin}^{+(n-1)}}}{n}, \frac{\sum_{Q_{begin+1}^{+(n-1)}}}{n}, \dots, \frac{\sum_{Q_{end}^{-(n-1)}}}{n} \right]$$

20
 21 In our analysis, 41 different seasons of low-flow data were evaluated over the period of 1968-2008
 22 (**Figure 12-4**). The 15-day low flows ranged in magnitude from $73.9 \text{ m}^3 \text{ s}^{-1}$ ($2,610 \text{ ft}^3 \text{ s}^{-1}$) to $294.5 \text{ m}^3 \text{ s}^{-1}$
 23 ($10,400 \text{ ft}^3 \text{ s}^{-1}$) and we found that the last eight years (2000-2008) contained the 1st, 2nd, 3rd, 4th, 7th, 8th,
 24 9th, and 10th lowest 15-day flows over the period of record (**Figure 12-4**, left). This alone illustrates the
 25 necessity of the low-flow frequency update, since the previous work conducted by USGS was only

- 1 current through 2002. The 15-day low-flow period occurred most frequently (~60% of the time)
 2 between the third week in August and first week of September (**Figure 12-4**, right).
 3

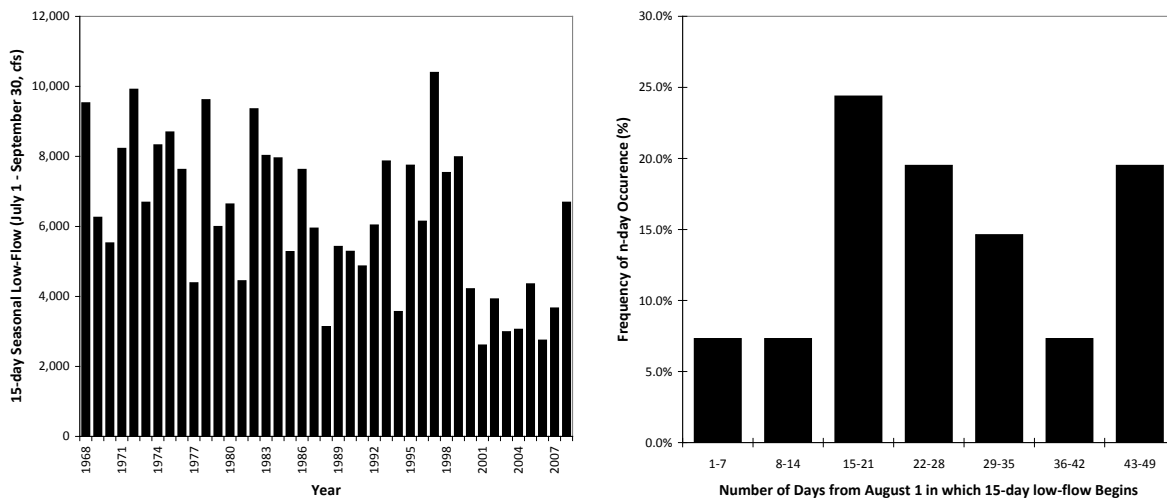

- 4
 5
 6 **Figure 12-4. N-day low-flow analysis for Yellowstone River at Miles City (1968-2008).**
 7 (Left) Annual 15-day seasonal low-flow data over the period of record at Miles City. (Right) Number of days
 8 following August 1 in which the 15-day low flow began at Miles City.
 9

10 12.3.2 Low-flow Frequency Analysis

11
 12 Weibull plotting positions were assigned according to **Equation 12-4** for the low-flows, where $p =$
 13 cumulative probability of occurrence, $m =$ low-flow rank according to magnitude (smallest to the
 14 largest), and $n =$ number of years of a given record. The three parameter Log-Pearson Type III
 15 distribution was fitted using SWSTAT and **Equation 12-5** where $\bar{y} =$ the mean of the log transformed
 16 seasonal low-flow series, $s_y =$ is the standard deviation of that same data series, and $K_j =$ the frequency
 17 factor (which is a function of the desired non-exceedence probability and the calculated skew coefficient
 18 of the log-transformed data). Tables for identification of K_j as a function of recurrence interval and skew
 19 coefficient are found in most hydrologic texts.
 20

21 **(Equation 12-4)**
$$p = \frac{m}{(n+1)}$$

22
 23 **(Equation 12-5)**
$$\log Q_j = \bar{y} + K_j s_y$$

24
 25 Using the methodology described previously, we computed a 15Q10 of $99.4 \text{ m}^3\text{s}^{-1}$ ($3,510 \text{ ft}^3\text{s}^{-1}$) for the
 26 Yellowstone River at Miles City (**Table 10-2**) which is significantly lower than the previously published
 27 14Q10 (111.7 cms , $3,940 \text{ ft}^3\text{s}^{-1}$) in McCarthy (2004); the principal difference being the inclusion of six

1 years of additional low-flow data¹. To verify that this discrepancy was not the change in duration, a
 2 15Q10 discharge was also computed by DEQ for the same period as McCarthy (i.e. 1968-2002). This
 3 yielded nearly identical results (**Table 12-2**). Also shown, are estimated 15Q10s for other gaged sites in
 4 the project reach (i.e., Forsyth and Glendive) which were estimated using a scaling factor based on the
 5 ratio of the mean discharges over a common period during August and September (2003-2007)². The
 6 scaling factor was very close to 1.0 for all sites, and was estimated for Terry. Graphical results of the 15-
 7 day low-flow frequency analysis for the Miles City gage site is shown in **Figure 12-5**.

8
 9 **Table 12-2. Comparative summary of 15Q10 low-flow analysis for the Lower Yellowstone River.**

Location	DEQ 15Q10 (1968-2002) $\text{m}^3 \text{s}^{-1}$ ($\text{ft}^3 \text{s}^{-1}$)	USGS 14Q10 (1968-2002) $\text{m}^3 \text{s}^{-1}$ ($\text{ft}^3 \text{s}^{-1}$)	DEQ 15Q10 (1968-2009) $\text{m}^3 \text{s}^{-1}$ ($\text{ft}^3 \text{s}^{-1}$)	Aug-Sep MAD (common period) $\text{m}^3 \text{s}^{-1}$ ($\text{ft}^3 \text{s}^{-1}$)	Scale factor	Final 15Q10 $\text{m}^3 \text{s}^{-1}$ ($\text{ft}^3 \text{s}^{-1}$)
Forsyth	n/a	n/a	n/a	119.9 (4,234)	1.009	100.2 (3,540)
Miles City	113.7 (4,000)	111.7 (3,940)	99.4 (3,510)	118.8 (4,195)	1.000	99.4 (3,510)
Terry	n/a	n/a	n/a	n/a	1.005 ^{EST}	100.0 (3,530)
Glendive	n/a	n/a	n/a	120.1 (4,240)	1.011	100.5 (3,550)

10
 11

¹ A preliminary update for low-flow frequency has been completed USGS (provisional data). The updated 14Q10 for the new period of record (1966-2009) is $97.697 \text{ m}^3 \text{ s}^{-1}$ ($3,450 \text{ ft}^3 \text{ s}^{-1}$) (P. McCarthy, personal communication), very close to our estimate of $99.4 \text{ m}^3 \text{ s}^{-1}$ is very reasonable.

² Insufficient data were available to compute 15Q10 flows at the Forsyth and Glendive gages. Additionally, use of different periods of record would result in inconsistent low-flow frequencies between the sites. As a result, a scaling factor was proposed by DEQ whereby 15Q10 discharges at Forsyth and Glendive were identified using the ratio of the August-September mean annual discharge at Miles City from its 15Q10. The scaling factors were computed over a common period of record of low flows (2003-2007).

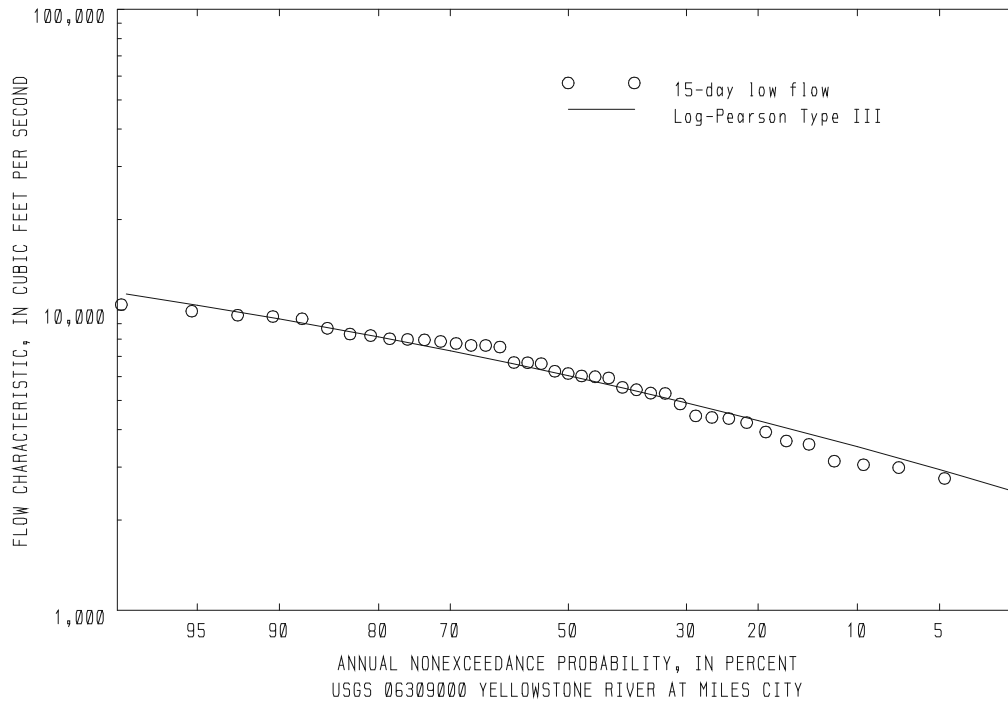

1
2
3 **Figure 12-5. Log-Pearson Type III low-flow frequency curve for the Yellowstone River at Miles City.**
4

5 **12.4 Final Design Flow Recommendation**

6
7 Due to the fact that the 15Q10 is not a consistently reported low-flow statistic, DEQ is recommending
8 the use of the 14Q10 for all nutrient criteria design flows. It is commonly reported by USGS, is very close
9 to the suggested duration-frequency identified in our analysis, and is a period over which we believe
10 discharges will ultimately be able to control their waste-treatment processes. Therefore in the criteria
11 development work for the Yellowstone River, we used the provisional 14Q10 of $97.697 \text{ m}^3 \text{ s}^{-1}$ ($3,450 \text{ ft}^3$
12 s^{-1}) at Miles City which has recently been determined by USGS (personal communication, P. McCarthy).
13 This translates to a headwater flow of $98.576 \text{ m}^3 \text{ s}^{-1}$ ($3,481 \text{ ft}^3 \text{ s}^{-1}$)¹.
14

15 **12.5 Design Climate**

16
17 The design climate for the criteria analysis is described in this section.

¹ It should be noted that when applying the Miles City design flow in combination with the scaled headwater boundary conditions, we could not exactly achieve the specified design flow at Miles City and Glendive. Rather there was some variation around the true value at each site ($\pm 5\%$) due to differences between the statistic and the actual water balance. We will incorporate this $\pm 5\%$ variance into the uncertainty analysis.

12.5.1 Climatic Conditions Associated with the 14Q10

Climatic conditions coincident with the 14Q10 are required for criteria development. It would be inappropriate to apply meteorological information outside of that context. To some degree, summer weather conditions (or climate in the context of long term weather averages) are independent of streamflow, especially in a river like the Yellowstone whose flow depends to a large extent on the prior winter's snowpack. As a result, low-flows do not necessarily depend on summer climatic conditions and therefore an underlying climatic series is needed to go along with the assigned design flow. To ensure that we maintain the 10% chance low-flow event (as implied in the selected streamflow condition), a 1-yr climate is required¹.

We have already shown that the 14Q10 low-flow condition can occur most any time during the seasonal low-flow calculation period (e.g., July 1 – September 30). Most frequently though, it occurs during the 3rd and 4th week of August as shown in **Figure 12-4** (Right panel) which means we should apply the climatic conditions from that period to our analysis (i.e., August 14-28th). The only challenge is finding an unbiased daily estimator of this period. Because any selection by DEQ may be considered preferential, and period-based averages are also in-appropriate (i.e., they tend to mute diurnal variation), we used an independent data source to develop the design climate as described in the next section.

12.5.2 Typical Meteorological Year

A typical meteorological year (TMY) is a pre-determined dataset containing hourly meteorological values that typify a location over a longer period of time (in most cases 30 years). The National Renewable Energy Laboratory (NREL) currently publishes one such TMY dataset which includes stations specific to our project area (i.e., Miles City and Glendive, MT²). We used the information from 1976-2005 to develop the design climate consistent with the most probable low-flow period. The data consists of 12 typical meteorological months (January through December) that are concatenated together without modification to form a single year of serially complete data (NREL, 2007; Wilcox and Marion, 2008). Missing data are filled or interpolated when necessary, giving the dataset natural diurnal and seasonal variation.

¹ A climatic condition with probability of 1.0 is required (i.e., 100% chance that this climate condition would happen every year) to ensure that the 10% chance non-exceedance probability of the low-flow condition is maintained (i.e., to not alter the overall frequency of occurrence). In other words, the probabilities are multiplicative, and a 0.10 streamflow probability multiplied by 1.0 climate probability is still a 0.10 chance occurrence event.

² The two TMY datasets available for our project site are: 742300 Miles City Municipal Airport and 726676 Glendive AWOS. The Miles City site had 22 years of candidate data (1976-2005), which excluded six years influenced by volcanic eruptions at El Chichón in Mexico in 1982 and Mount Pinatubo in the Philippines in 1991, as well as two years of missing data (i.e., 22/30 years were considered). The Glendive station only had 12 candidate years of record, therefore was not suitable for our analysis.

1 The TMY selection method involves identifying representative individual months from different years
 2 judged to be most typical per the TMY algorithm and combining them together to form a complete year.
 3 Nine daily weighted indices are used which include: (1) dry bulb and dew point temperature (minimum,
 4 maximum, and mean for each); (2) maximum and mean wind velocity; and (3) total global horizontal
 5 solar radiation. Weightings are: 10/20 on radiation, 4/20 on air temperature, 4/20 on dew point, and
 6 2/10 on wind velocity. Given the interdependence of many of these variables, the TMY is a good
 7 approximation of expected climatic conditions. Because adjacent months in the TMY may be selected
 8 from different years, discontinuities can potentially occur. Six hours on each side of the month are
 9 smoothed to accommodate this difference (NREL, 2007; Wilcox and Marion, 2008). An example TMY
 10 series of temperature for Miles City is shown in **Figure 12-6**.
 11

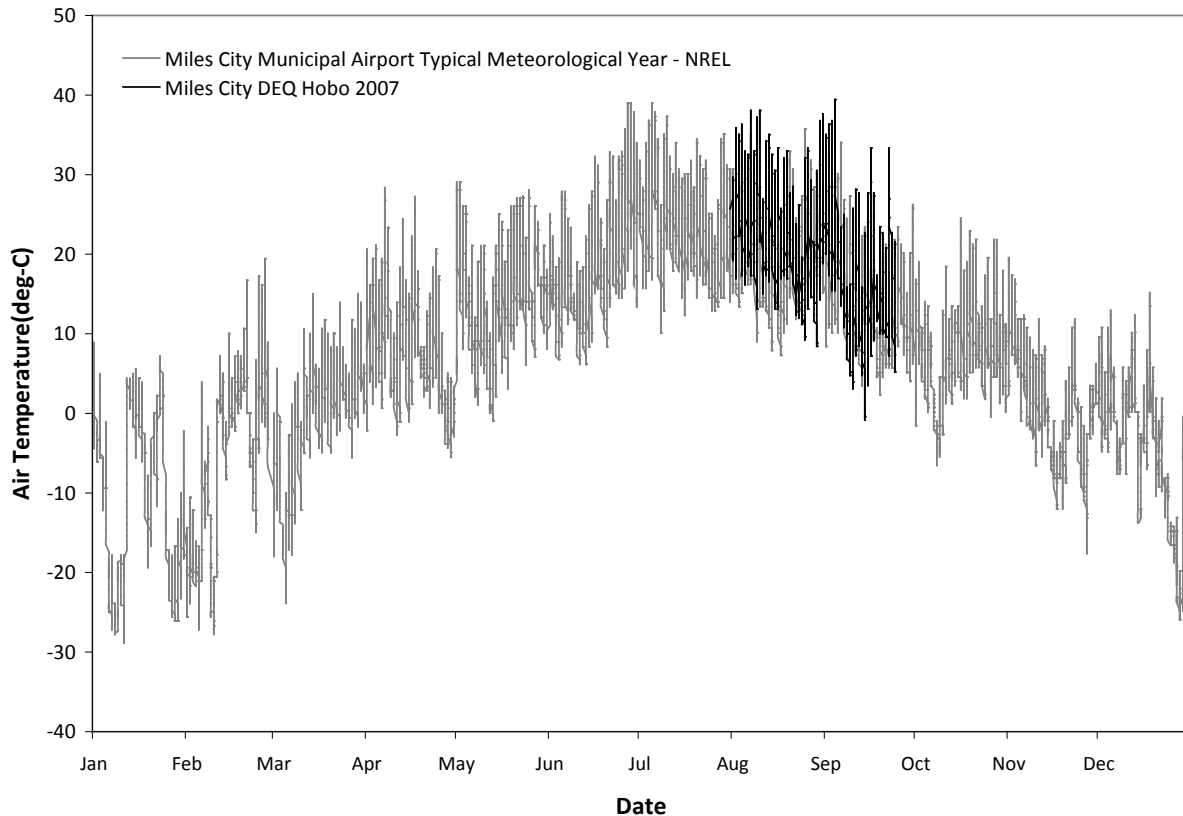

12
 13 **Figure 12-6. Example TMY air temperature plot for 742300 Miles City Municipal Airport.**
 14 Field observations from 2007 are shown for reference purposes.

15 16 **12.5.3 Adjustments to the TMY Based on Field Observations**

17
 18 As indicated previously (**Section 7.4**), the Miles City Municipal Airport (APT) is not sufficiently
 19 representative of the river corridor. To better approximate river conditions we used the corrections
 20 shown in **Table 12-3**. These were determined through paired station analysis and indicate that the river
 21 had consistently lower wind speed and higher dew point than the APT. The disparity was due to the fact
 22 that the airport is located on a bluff adjacent to the river and experiences different climatic conditions
 23 than the river itself. Plots of adjusted TMY data are shown in **Figure 12-7** and compare very similarly to
 24 conditions during 2007.
 25

1
2
3
4
5
6
7
8
9
10

Table 12-3. TMY adjustments based on paired station analysis from August 1- September 21, 2007.

Climatic Variable	Miles City Municipal APT	DEQ Hobo Site (on island in river)	Adjustment Factor
Temperature	21.0	21.0	0.0 degrees C
Dew Point	6.5	8.2	+1.7 degrees C
Wind Speed @ 10 m	4.2	1.1	x 0.32 m/s
Cloud Cover	0.15	N/A	none

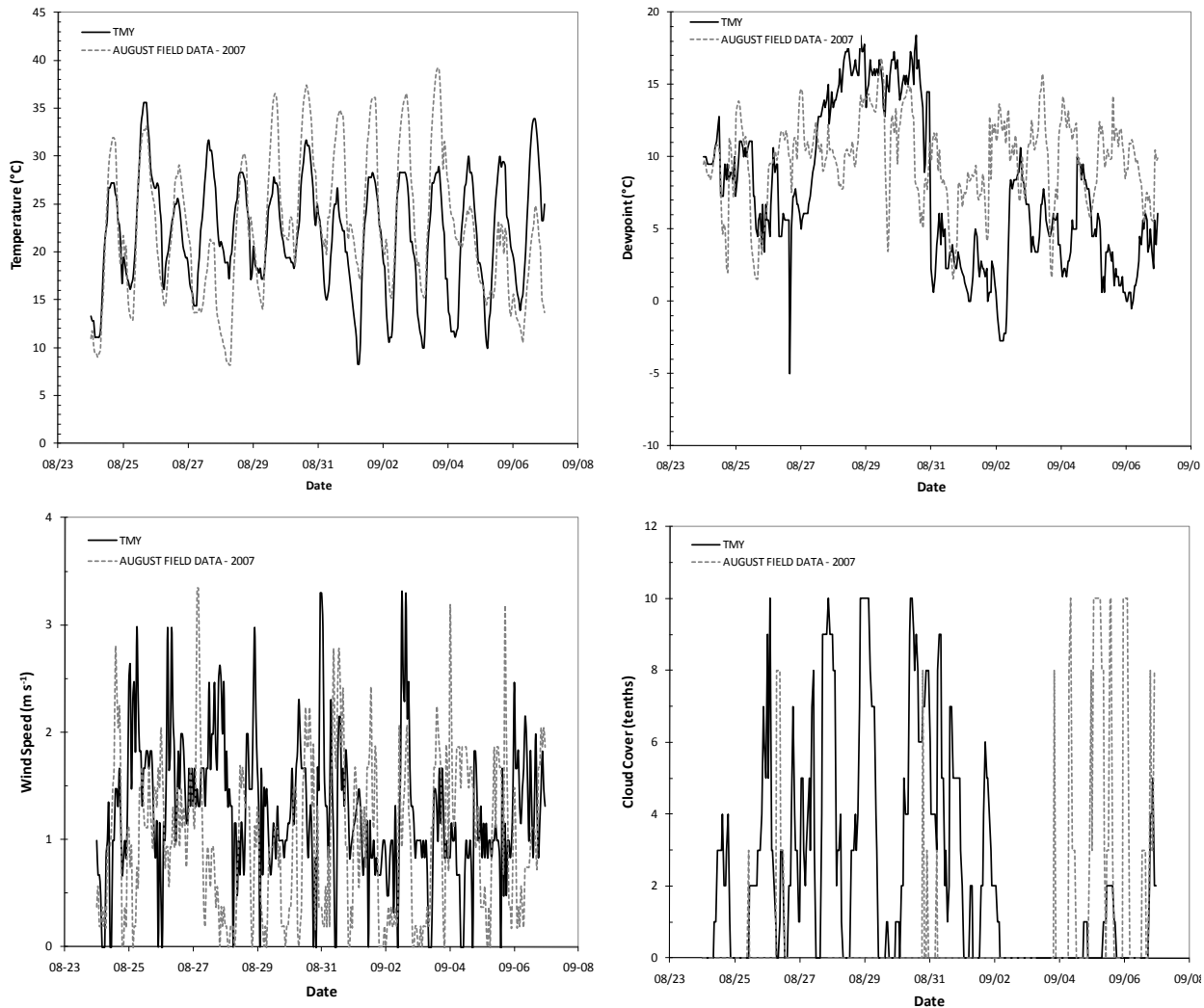

Figure 12-7. Plots of adjusted TMY in comparison with August 2007 field data. (Top left/right) Air temperature and dew point temperature (°C). (Bottom left/right) Wind speed (m s⁻¹) and cloud cover (tenths). Adjustments are based on **Table 12-3**.

12.5.4 Extrapolation of TMY Data to the Other Climatic Regions in the Project

The adjusted TMY data from Miles City was then extrapolated to other regions in our project corridor based on the long-term relationships from Hydmet (2009). Associated averages and adjustment factors for the four climatic zones used in our model (i.e., Sweeney Creek, Miles City APT, Terry AgriMet, and Glendive AgriMet) are shown in **Table 12-4**.

Table 12-4. TMY adjustment factors for climatic regions used in the Q2K model.

Data from 1999-2008. Miles City APT site already adjusted according to the factors in Table 12-3.

Location	Air Temp. (°C)	TMY Adjust (°C)	Dew point Temp. (°C)	TMY Adjust (°C)	Wind Speed @ 7 meters (m/s)	TMY Adjust (m/s)	Cloud Cover (tenths)	TMY Adjust (tenths)
Sweeney Creek	19.5	+0.2	8.1 ¹	+0.2	2.8	No adj.	Same	No adj.
Miles City APT	19.3	---	7.9	---	1.3	---	---	---
Terry	18.4	-0.9	7.3	-0.6	2.4	No adj.	Same	No adj.
Glendive	17.8	-1.5	7.5	-0.4	2.4	No adj.	Same	No adj.

¹ Sweeney Creek dewpoint not consistent with other locations. Used ratio between Sweeney Creek and W7PG-10.

In summary, the overall trend in the data seems to be:

- A slight longitudinal cooling effect with air temperature from Forsyth to Glendive. This was confirmed by a secondary data source (PRISM Climate Group, 2006).
- Fairly consistent dew point at all locations, except at Sweeney Creek, where it was higher.
- Much higher wind speeds at Sweeney Creek, Terry, and Glendive than in Miles City.
- Inconclusive information on cloud cover.

Of all climatic variables, wind speed was of most interest due to the large difference between the adjusted Miles City site and that of the other sites. Evaluation of wind rose data provides some insight about the differences (**Figure 12-8**). The primary consideration appeared to be wind direction, and its relationship with river aspect. Sites most perpendicular to the river appear to have more wind sheltering than those in adjacent areas. For example, the DEQ Hobo and Miles City APT indicate significantly different percent calms (21% vs. < 6%), nearly three times greater in the river than at the airport. A shift in direction also occurred indicating eddy and turbulent effect.

There were also differences longitudinally. Percent calms were much lower at Terry and Glendive ($\approx 1\%$) than at Miles City APT. This is at least qualitatively indicative that the lower river should be both windier and cooler than the upper river. Such assertions were verified through calibration of water temperature in the model and therefore the wind gradient was not altered except in the case of Miles City.

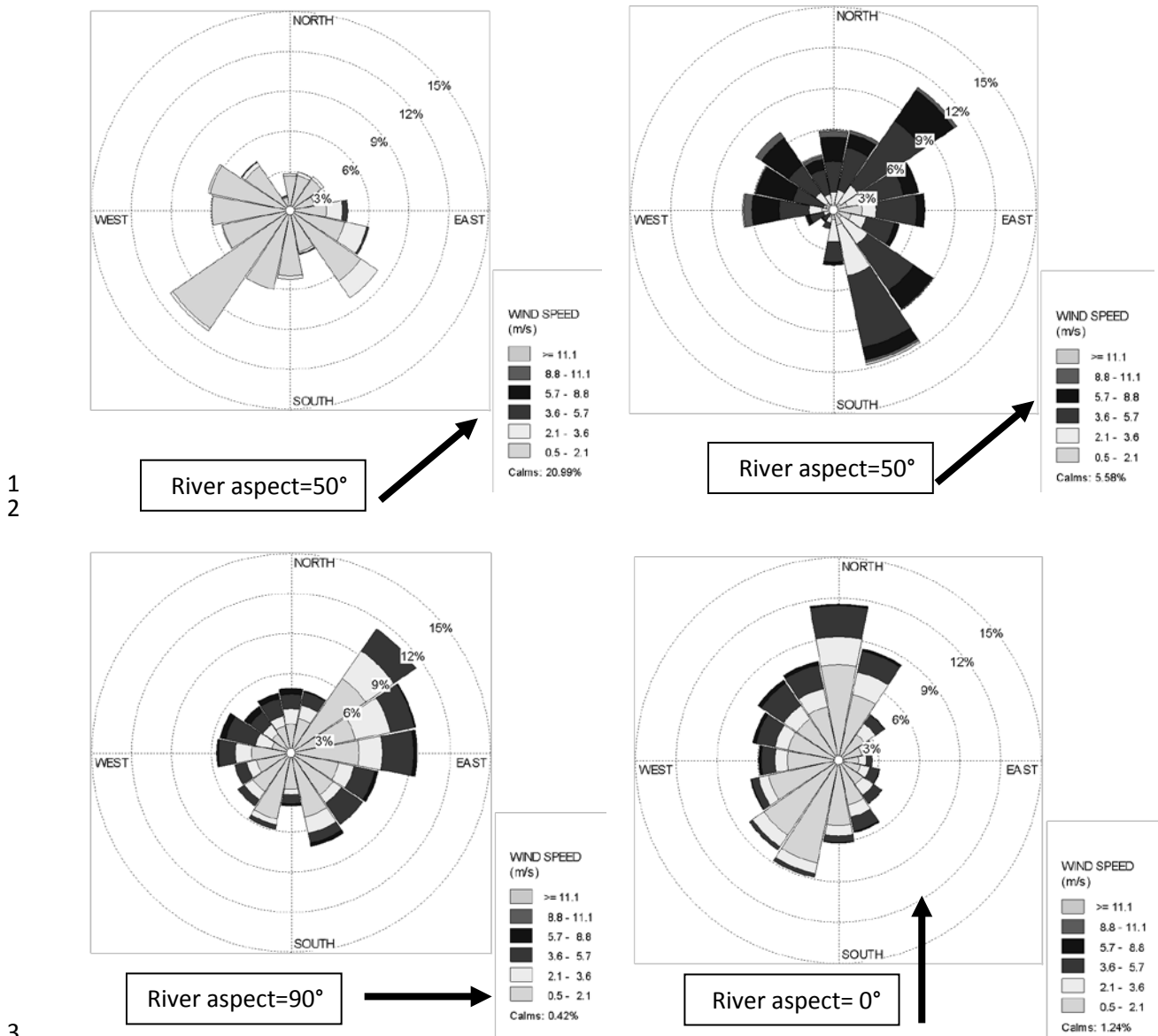

3
4
5 **Figure 12-8. Wind Rose data on the lower Yellowstone River.**

6 (Top left/right panel) Wind observations at the DEQ Roche Juan Island and Miles City APT. (Bottom left/right panel)
7 Same but for Terry and Glendive AgriMet. Percent calms increased significantly between the river station and
8 Municipal airport site. This illustrates the effect of sheltering by topography and vegetation. In cases where the
9 wind vector was parallel to the river aspect, these effects were diminished.

11 12.6 Water Quality Boundary Conditions

12
13 Appropriate water quality boundary conditions must also be specified. Included are the headwater
14 boundary condition (i.e., Forsyth), incoming tributary information, irrigation exchanges, etc. We
15 compiled data from the ten lowest-flow years on record to attribute these features for the Yellowstone
16 River. Some data was available most years and is shown in **Table 12-5**. Diurnal data was only available
17 for two of the years (2000 & 2007). A direct average of the observations was applied in the model.

1 **Table 12-5. Low-flow water quality summary for the Yellowstone River.**

2 Data from USGS at Forsyth (headwater boundary condition of our study reach).

Low-flow ranking, time (am/pm), and date of observation (out of 41 years)	Temperature (°C)	pH	SC (µs/cm)	DO (mg/L)	Alkalinity (mg/L)	TSS (mg/L)	TN (mg/L)	NO ₂ +NO ₃ (mg/L)	NH ₄ (mg/L)	TP (mg/L)	SRP (mg/L)	Phyto (µg/L)
Rank=1, 1200 pm August 21, 2001	23	8.4	805	9.6	161	18	0.47	0.05	<0.04	0.032	<0.02	n/a
Rank=2, 1216 pm August 9, 2006	26	n/a	596	n/a	n/a	n/a	n/a	n/a	n/a	n/a	n/a	n/a
Rank=3, 1000 am August 21, 2003	22	8.3	701	8.2	129	22	0.48 ^E	0.06 ^E	<0.04	0.042	<0.02	n/a
Rank=4 1200 pm Sept. 8, 2004	n/a	8.4	n/a	n/a	145	37	0.52	0.15	<0.04	0.056	<0.006	n/a
Rank=5 0940 am August 30, 1988	18	n/a	945	n/a	n/a	n/a	n/a	n/a	n/a	n/a	n/a	n/a
Rank=6 0310 pm August 30, 1994	18	n/a	673	n/a	n/a	n/a	n/a	n/a	n/a	n/a	n/a	n/a
Rank=7 _a 0430 pm August 18, 2007	23.5	8.7	762	9.0	170	26	0.519	0.102	0.015	0.041	0.003	8.0
Rank=7 _b 0430 pm August 27, 2007	21.6	8.7	760	9.5	170	35	0.507	0.107	0.008	0.044	0.003	9.6
Rank=8 0900 am August 2, 2002 ¹	20	8.3	540	8.2	130	62	0.74	0.36	<0.04	0.107	0.02	n/a
Rank=9 _a 0300 pm August 16, 2000	22	8.9	636	9.5	134	18	n/a	<0.05	<0.02	n/a	<0.01	n/a
Rank=9 _b 1200 pm August 26, 2000	21.2	8.5	676	7.5	n/a	58	0.39	<0.05	<0.02	0.031	<0.01	6.9
Rank=10 1231 pm August 9, 2005	22.5	n/a	590	n/a	n/a	n/a	n/a	n/a	n/a	n/a	n/a	n/a
Averages²	21.8	8.6	714	8.9	152	31	0.48	0.07	0.009	0.041	0.003	8.2

3 ¹This data excluded from analysis (low-flow period was significantly after sampling date).4 ²For values below reporting limit (e.g., <0.02, etc.) use ½ detection limit which is ¼ the reporting limit.5 ^E Estimated values

6

7 For variables less monitored (CBOD, ISS, detritus, etc.), relationships established during August and
8 September 2007 were used. This included the scaling factors of ISS=0.8*TSS and detritus = 0.15*TSS (as
9 described previously). For the diurnal data, much less information exists. Data from August 2000 and
10 2007 were used to establish appropriate ranges in field water quality variables (i.e., temperature, pH,
11 and DO). These data are shown in tabular form in **Table 12-6**.

12

13

14

15

16

1 **Table 12-6. Diurnal variation in low-flow water quality.**

Period	Temp Range/2 (°C)	DO Range/2 (mg L ⁻¹)	pH Range/2 (pH units)	Conductivity Range/2 (μS cm ⁻¹)
August 26-28, 2000	1.15	0.84	0.05	n/a
August 17-26, 2007	0.95	0.87	0.06	n/a
Average	1.05	0.85	0.06	n/a

2
3 A sine function was used to distribute these values over the course of a day (**Equation 11-6**), where
4 S_t =state variable at time t , \bar{S}_r = state variable mean for the day, S_r = the range/2 for the day, and t_{radians}
5 = the hour of the day in radians.

6
7 (**Equation 12-6**)
$$S_t = S_r(-\sin t_{\text{radians}}) + \bar{S}_r$$

8
9 It should be noted that this method implicitly assumes that maximum and minimum temperature, pH,
10 and DO occur at $\frac{1}{4}$ and $\frac{3}{4}$ of the day (6:00 a.m. and 6:00 p.m.). While some exceptions are apparent, we
11 generally feel it is reasonable given that each coincides with the approximate beginning and end of the
12 photoperiod. The nighttime minima probably actually occur slightly later in the morning than indicated
13 by the sine function (by perhaps as much as two hours), however, we did not use a time lag to shift the
14 data.

15 16 **12.7 Other Boundary Conditions**

17
18 Other boundary conditions such as tributaries, groundwater, etc. also need to be consistent with
19 conditions expected during the critical low-flow period. In cases where tributaries were gaged (such as
20 on Rosebud Creek, and the Tongue and Powder rivers), we took the mean data corresponding to the 10
21 lowest flow years on the Yellowstone (i.e., the same years in **Table 12-5**). This information is shown in
22 **Table 12-7**.

23
24 Inherently this approach ensured that we weren't simply selecting water quality data from the 10-
25 lowest flow years on the tributaries, but rather with years corresponding to the Yellowstone (i.e.,
26 tributaries have a different source water origin than the Yellowstone so they do not necessarily have to
27 have a low-flow year when the Yellowstone is experiencing one). Overall, it appears that August flows
28 for those years are much lower than the long-term average. Values were approximately 15-20% of the
29 long term average for unregulated tributaries (Rosebud Creek and Powder River) and slightly higher for
30 regulated systems like the Tongue River (35%, most likely due to storage in the upstream Tongue River
31 Reservoir).

32
33 For diffuse tributaries, we merely assumed that they stayed the same due to their insignificance.
34 Similarly, irrigation diversions and return flows were assumed to be identical to as monitored during
35 August 2007 (recall that 2007 was the 7th lowest flow year on record).

1 **Table 12-7. Low-flow conditions on gaged tributaries to the Yellowstone River.**

Yellowstone River low-flow ranking (out of 41 years)	Year	06296003 Rosebud Creek at mouth nr Rosebud Record=1975-2006 ($\text{m}^3 \text{s}^{-1}$)	06308500 Tongue River at Miles City Record=1938-2010 ($\text{m}^3 \text{s}^{-1}$)	06326500 Powder River near Locate Record=1938-2010 ($\text{m}^3 \text{s}^{-1}$)
1	2001	0.082 (2.91 $\text{ft}^3 \text{s}^{-1}$)	0.600 (21.2 $\text{ft}^3 \text{s}^{-1}$)	2.093 (73.9 $\text{ft}^3 \text{s}^{-1}$)
2	2006	0.000 (0.00 $\text{ft}^3 \text{s}^{-1}$)	0.365 (12.9 $\text{ft}^3 \text{s}^{-1}$)	0.062 (2.19 $\text{ft}^3 \text{s}^{-1}$)
3	2003	0.000 (0.00 $\text{ft}^3 \text{s}^{-1}$)	2.685 (94.8 $\text{ft}^3 \text{s}^{-1}$)	0.153 (5.42 $\text{ft}^3 \text{s}^{-1}$)
4	2004	0.000 (0.02 $\text{ft}^3 \text{s}^{-1}$)	0.838 (29.6 $\text{ft}^3 \text{s}^{-1}$)	1.082 (38.2 $\text{ft}^3 \text{s}^{-1}$)
5	1988	0.000 (0.00 $\text{ft}^3 \text{s}^{-1}$)	1.147 (40.5 $\text{ft}^3 \text{s}^{-1}$)	0.037 (1.3 $\text{ft}^3 \text{s}^{-1}$)
6	1994	0.014 (0.50 $\text{ft}^3 \text{s}^{-1}$)	0.617 (21.8 $\text{ft}^3 \text{s}^{-1}$)	1.096 (38.7 $\text{ft}^3 \text{s}^{-1}$)
7	2007	n/a	4.112 (145 $\text{ft}^3 \text{s}^{-1}$)	7.439 (262 $\text{ft}^3 \text{s}^{-1}$)
8	2002	0.078 (2.75 $\text{ft}^3 \text{s}^{-1}$)	0.530 (18.7 $\text{ft}^3 \text{s}^{-1}$)	0.736 (26 $\text{ft}^3 \text{s}^{-1}$)
9	2000	0.000 (0.01 $\text{ft}^3 \text{s}^{-1}$)	2.144 (75.7 $\text{ft}^3 \text{s}^{-1}$)	0.272 (9.6 $\text{ft}^3 \text{s}^{-1}$)
10	2005	0.007 (0.26 $\text{ft}^3 \text{s}^{-1}$)	4.225 (149 $\text{ft}^3 \text{s}^{-1}$)	1.767 (62.4 $\text{ft}^3 \text{s}^{-1}$)
Low-flow Mean		0.020 (0.72 $\text{ft}^3 \text{s}^{-1}$)	1.726 (61.0 $\text{ft}^3 \text{s}^{-1}$)	1.474 (52.0 $\text{ft}^3 \text{s}^{-1}$)
Long Term Mean		0.204 (7.20 $\text{ft}^3 \text{s}^{-1}$)	4.984 (176 $\text{ft}^3 \text{s}^{-1}$)	5.805 (205 $\text{ft}^3 \text{s}^{-1}$)
% Long Term		10%	35%	25%

2

1

13.0 WATER QUALITY MODEL NUTRIENT ADDITIONS TO IDENTIFY NUMERIC CRITERIA

Nutrient additions were completed with the models using conditions described previously so that DEQ could determine appropriate nutrient thresholds for the Yellowstone River. A number of plausible water quality endpoints were evaluated including DO, pH, benthic algae, TOC, etc., (see **Figure 1-1**). The most limiting variable would become the driver for the numeric nutrient criteria (i.e., the one that would push the river into a state of non-compliance with a water quality standard first). The August 2007 parameterization was used for the analysis, which we felt was best suited toward low-flow, high-productivity conditions when criteria apply. This was used in combination with information in **Section 12.0** to determine critical nutrient limits. Methodologies and findings are detailed in this section.

13.1 Methodology Used to Identify Critical Nutrient Concentrations

To resolve the water quality response of the river to nutrients, we adjusted nutrient concentrations in the model until a water-quality limiting eutrophication response ensued (similar to what is done in a field dosing study but through the mechanistic relationships in the model). When considering the lower Yellowstone River, nutrient additions were required because concentrations are below those that impair use (see **Section 12.0**). However, it should be noted that nutrient *reductions* could have theoretically been necessary if the river were already in excess of state water quality standards. If this would have been true, DEQ would have run nutrient reduction scenarios instead.

The following reaches in the river were considered for criteria development to be consistent with previously established criteria assessment units (**Section 4.4**):

- Forsyth to Powder River (reflective of Criteria Assessment Unit 3 –Big Horn to Powder river)
- Powder River to Glendive (reflective of Criteria Assessment Unit 4 –Powder River to state-line)

Two scenarios were evaluated for each reach: (1) if nitrogen (N) was limiting and (2) if phosphorus (P) were limiting. Effectively this covers all plausible outcomes and allows us to set control limits for both N and P over the growing season.

13.1.1 Form of Nutrient Additions and How They Were Introduced Into Q2K

Nutrient additions in Q2K were done through the adjustment of soluble nutrients in the model. Perturbation was completed so that both the headwater boundary condition and diffuse source accretion terms¹ held consistent soluble N and P concentrations across the modeling extent. Dosing increments used in each scenario are shown in **Table 13-1**, with one nutrient being set at non-limiting

¹ A different diffuse term was used every 10 km

1 levels so that the other could be evaluated¹. In all P evaluation scenarios, soluble N was set to 1,000 μg
 2 L^{-1} (a non-limiting level) whereas for all N evaluations, soluble P was set to 100 μg L^{-1} (again non-
 3 limiting). Wastewater inflows were also removed to create a more uniform nutrient profile in the river.
 4

5 **Table 13-1. Soluble nutrient concentrations used to evaluate limiting water quality responses.**

Trial	Nitrogen Limiting		Phosphorus Limiting	
	NO_3^- (μg L^{-1})	SRP (μg L^{-1})	NO_3^- (μg L^{-1})	SRP (μg L^{-1})
1	6	100	1,000	2
2	8	100	1,000	3
3	10	100	1,000	4
4	15	100	1,000	6
5	20	100	1,000	8
6	25	100	1,000	10
7	30	100	1,000	15
8	50	100	1,000	20
9	70	100	1,000	30
10	100	100	1,000	50

6
 7 Output tables were then constructed for each scenario to identify thresholds where nutrient levels
 8 would most impact beneficial uses (e.g., pH vs. soluble N, DO standards vs. soluble P, etc.). These are the
 9 foundation of our nutrient criterion for the river. Endpoints that apply to the Yellowstone River (all
 10 related to water use class B-3) are reiterated below and preface our analysis:

- 11 • **Dissolved oxygen**, which according to ARM 17.30.625 must not be reduced below applicable
 12 Circular DEQ-7 levels. For B-3 waters, instantaneous minima should be greater than 5 mgO_2 L^{-1}
 13 to protect early stages of aquatic life (DEQ-7).
- 14 • **pH**, where induced hydrogen ion concentration variation must be less than 0.5 units within the
 15 range of 6.5 to 9.0, and maintained without change beyond those limits to protect aquatic life.
 16 Natural pH above 7.0 must also be maintained above 7.0. (ARM 17.30.625). Further discussions
 17 regarding pH are contained within this section.
- 18 • **Algae**, whose benthic biomasses should be less than 150 mg m^{-2} to protect recreational use
 19 (Suplee, et al., 2009). DEQ requires that the mean biomass of the wadeable region² not exceed
 20 this threshold in large rivers.
- 21 • **Total dissolved gas**, which should not exceed 110% of saturation (DEQ-7).
- 22 • **TOC**, whose removal is required at the levels shown in **Table 13-2** (EPA rule EPA 816-F-01-014)³.

23

¹ The model operates on Liebig's Law of the Minimum, where only a single nutrient can limit growth at any given time, thus both required consideration.

² Wadeable defined as ≤ 1 meter, (Flynn and Suplee, 2010), again see **Section 1.4**.

³ Primarily, we are concerned with whether or not any scenario would push the river over a required treatment threshold (i.e., such as >8 mg L^{-1} if the waterbody was already in the 4-8 mg L^{-1} range).

- 1 **Tale 13-2. Required removal of TOC based on EPA Stage 1 disinfectants and disinfection byproducts.**
 2 Based on EPA 816-F-01-014, June 2001.

Source Water TOC (mg/L)	Source Water Alkalinity (mg L ⁻¹ as CaCO ₃)		
	0-60	>60-120	>120
>2.0-4.0	35%	25%	15%
>4.0-8.0	45%	35%	25%
>8.0	50%	40%	30%

3
 4 **13.1.2 Upstream Boundary Condition Considerations**

5
 6 As mentioned previously, future conditions at our headwater boundary condition (Forsyth) will
 7 presumably change over time as the river is allowed to inch closer toward the identified criteria [recall
 8 that our model begins in the middle of criteria assessment unit 3 (**Section 4.4**) and any incremental
 9 increase in nutrients will alter water quality conditions at the beginning of our project reach]. An
 10 approach is therefore necessary to forecast these changes. After much consideration, two methods
 11 were used.

12
 13 First, for variables that have a direct relationship with total nutrients (such as phytoplankton Chl_a), the
 14 literature was relied upon to estimate the phytoplankton change that would occur with increasing
 15 nutrient levels. For other variables that have an unknown or indirect relationships with total nutrients
 16 (such as OrgN and OrgP, detritus, or other variables), the model was used to evaluate longitudinal
 17 buildup from ambient conditions and to prescribe a likely headwater condition that would minimize the
 18 gradient with respect to longitudinal distance (under the assumption that an equilibrium concentration
 19 could be achieved). These methods are better described below.

20
 21 Phytoplankton concentrations increase longitudinally given sufficient nutrients and light. For example,
 22 recent studies show that they can routinely reach concentrations of 70 µg Chl_a L⁻¹ in eutrophied rivers
 23 (Royer, et al., 2008). Concentrations also correlate well with total nutrients. A relationship has been
 24 observed between TP and phytoplankton concentration by many authors (Basu and Pick, 1995; Basu and
 25 Pick, 1996; Basu and Pick, 1997; Heiskary, et al., 2010; Van Nieuwenhuysse and Jones, 1996). One also
 26 exists with TN (Dodds, 2006). We can therefore estimate probable future phytoplankton values at our
 27 upstream study limit using one of the published equations in **Table 13-3**.

28
 29 Among those evaluated, we selected the Dodds (2006) equation for TN and the one from Basu and Pick
 30 (1996) for TP. Dodds (2006) was used for the lack of better information (it was the only one we could
 31 identify for N)¹ and justification for use of the TP equation it is as follows: (1) it was developed during
 32 summer conditions (similar to what we evaluated on the Yellowstone River), (2) it applies to large
 33 northern temperate rivers and produced results very similar to those observed in the Yellowstone (i.e.,
 34 in regard to observed TP and Chl_a concentrations), and (3) its results fall in the midrange of the studies

¹ The Dodds (2006) equation underestimated phytoplankton Chl_a concentration relative to the TN/phytoplankton concentrations measured in the river. Therefore, we used a constant Chl_a correction factor (Chl_a result from Dodds (2006) *2. 5 µg Chl_a L⁻¹) to make the estimates.

1 identified. Hence it was a good fit to our project. For each intended nutrient-addition scenario, the
 2 soluble N or P concentration in question was applied to the appropriate equation and the resultant
 3 phytoplankton concentration input into the headwater boundary condition prior to running the
 4 scenario.

5
 6 **Table 13-3. Published equations relating phytoplankton Chl a to TP or TN concentration.**

Authors	Sampling Timeframe	River(s) Description	Equation ¹
Van Nieuwenhuysse and Jones (1996)	May-September	292 temperature streams, mainly tributaries to the Missouri and Mississippi	$\text{Log (Chl}a) = -1.65 + 1.99 (\text{Log TP}) - 0.28 (\text{Log TP})^2$
Basu and Pick (1996)	July	31 large rivers (Strahler $\geq 5^{\text{th}}$ order) in southern Ontario and western Quebec (flow range $0.9\text{-}250 \text{ m}^3 \text{ s}^{-1}$)	$\text{Log (Chl}a) = -0.26 + 0.73 \text{ Log (TP)}$
Basu and Pick (1997)	May-October	Rideneau River, southern Ontario (mean annual flow $38.9 \text{ m}^3 \text{ s}^{-1}$)	$\text{Log (Chl}a) = -0.62 + 1.02 \text{ Log (TP)}$
(Dodds, 2006)	May-September	Similar to Van Nieuwenhuysse and Jones (1996), but original data re-analyzed focusing on TN	$\text{Log (Chl}a) = -1.25 + 0.68 \text{ Log (TN)}$
Heiskary, et al. (2010)	Summer-early fall	>40 streams and rivers (Strahler order $4^{\text{th}}\text{-}7^{\text{th}}$) in Minnesota, with summer flows from $1.8\text{-}233 \text{ m}^3 \text{ s}^{-1}$)	$\text{Log (Chl}a) = -1.82 + 1.47 \text{ Log (TP)}$

7 ¹ All units (nutrients and phytoplankton) are in $\mu\text{g L}^{-1}$.

8
 9 The second consideration was the remaining headwater conditions that would be affected by upstream
 10 changes in productivity. All variables will experience some alteration in the future. For example,
 11 variables may experience a net increase in mean constituent concentration (such as in the case of
 12 detritus, OrgN or P), while others will show greater diurnal variability (such as pH and DO). For the
 13 purpose of our analysis, we were most concerned with shifts in the nutrient-related species, specifically,
 14 the headwater organic nutrient concentration and detritus (both by-products of increased algal
 15 productivity).

16
 17 Given the lack of suitable alternatives to characterize these variables, the model itself was used to
 18 evaluate buildup rates in the downstream direction and prescribe the most likely headwater condition
 19 that would minimize the change in those variables with respect to distance. We first achieved the target
 20 soluble nutrient concentrations in the model as shown in **Figure 13-1** (Left panel) and then iterated
 21 headwater conditions until an approximate threshold or flattening was observed with respect to

1 distance¹ (**Figure 13-1**, Right panel). Once determined, these were used in the nutrient addition
 2 simulation as the anticipated change in the headwater boundary condition from upstream degradation
 3 over time². In this illustration, only Criteria Assessment Unit 3 was evaluated. A similar exercise would
 4 be required for Unit 4.

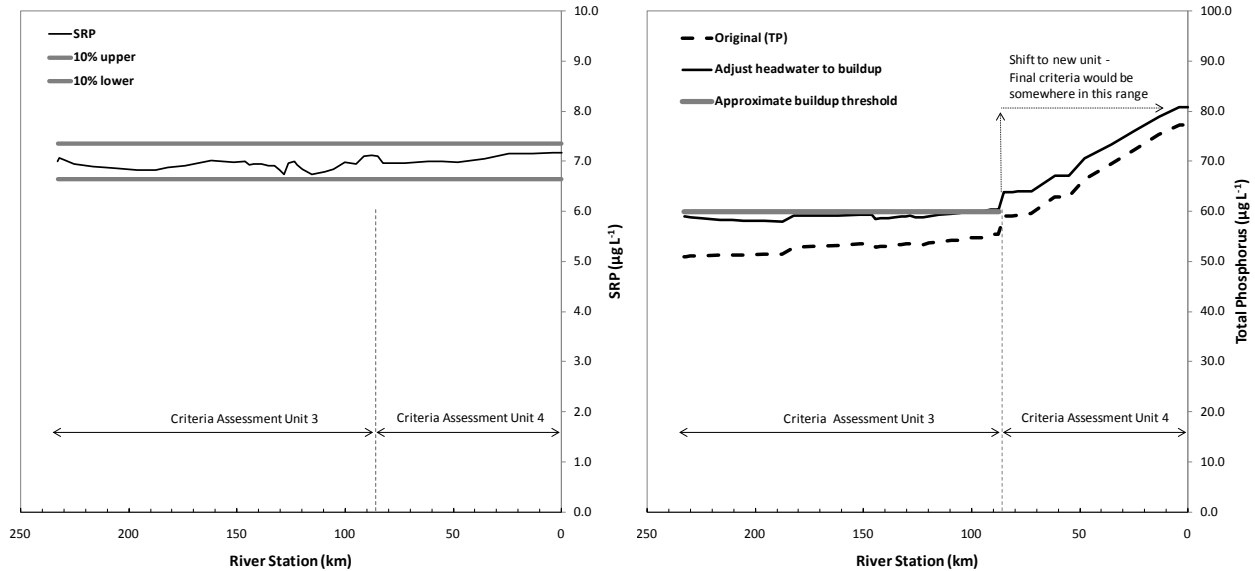

6
 7
 8 **Figure 13-1. Example of the iterative procedure required to assign headwater boundary conditions.**
 9 (Left panel) Soluble phosphorus simulation shown for one of the ten TP optimizations (in this instance the target
 10 SRP concentration was 7 µg L⁻¹). (Right panel) Adjustment of headwater TP concentration (through adjustment of
 11 OrgP) so that conditions reflect the approximate downstream buildup.

12
 13 In some instances, the headwater change was very apparent. Detritus is one such example shown in
 14 **Figure 13-2** (Left panel). It is evident from the plot that adjusted conditions much more closely reflect
 15 the continuum within in the channel. Adjustments are not exact, however, but this should not cause
 16 major concern as in such instances initial condition error diminishes in the downstream direction³. The
 17 phytoplankton change (from literature review described previously) is also shown (**Figure 13-2**, Right
 18 panel). Less of an equilibrium exists with this variable.

19

¹ It should be noted that this also required additional iteration of diffuse source terms. Any change in headwater conditions alters soluble nutrients (more mass going through hydrolysis reaction).

² Again, the idea is that factors change upstream of our modeled reach as the river moves closer to the nutrient standard. Once a different criteria unit was encountered, a new condition could be expected.

³ Other boundary conditions become increasingly important (see sensitivity analysis for verification).

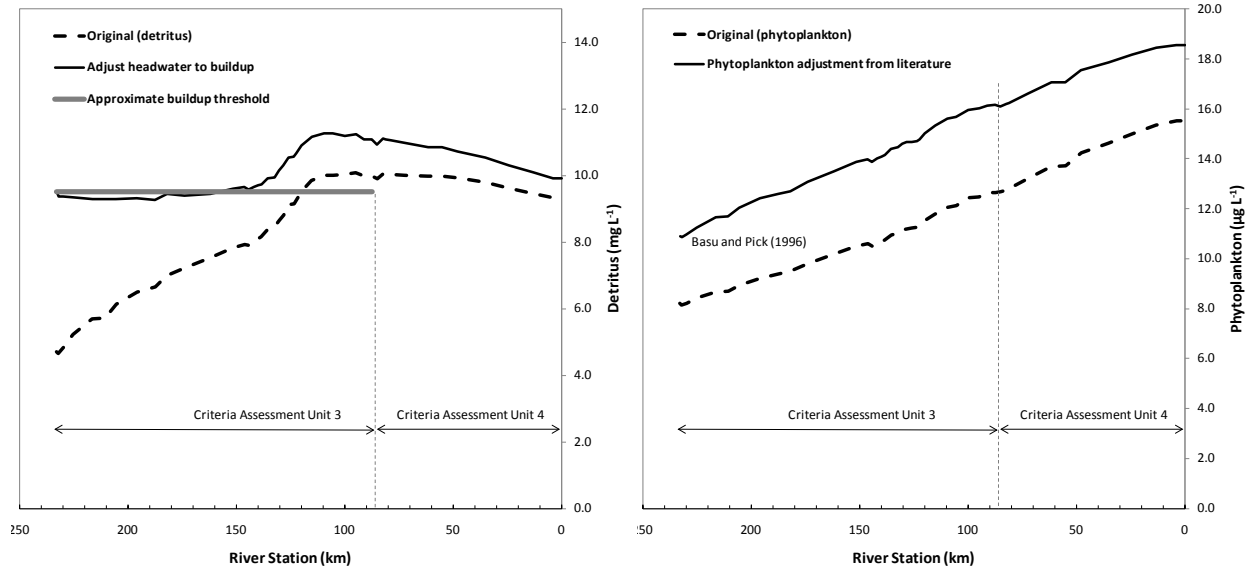

1
2
3 **Figure 13-2. Consideration of headwater detritus and phytoplankton concentrations.**

4 (Left panel) Longitudinal buildup in detritus. (Right panel) Phytoplankton adjustment to literature conditions ($7 \mu\text{g TP L}^{-1}$). Note that detritus (which is productivity based) peaks around km 125 while phytoplankton concentrations
5
6 continually increase in the downstream direction.

7 8 **13.2 Results of Nutrient Addition Simulations**

9
10 To reiterate, nutrients in the Yellowstone River are currently *below* levels that will cause violations to
11 state water quality standards and low-flow simulations with *added* nutrients were completed to identify
12 levels that would be limiting. Ten model runs with incremental changes in ambient N and P
13 concentrations were completed to assess the eutrophication response of the river. Results are shown in
14 the **Table 13-4** (for N) and **Table 13-5** (for P).

15
16 Output variables evaluated in each model run included total N and P concentration ($\mu\text{g L}^{-1}$); DO minima
17 (mg L^{-1}); DO delta (mg L^{-1}), i.e., maximum DO minus minimum DO at a station; pH maximum and
18 minimum; pH delta (maximum pH deviation between baseline and scenario condition); maximum mean
19 benthic algae biomass (excluding the four rapids, mgChla m^{-2}); highest benthic algae biomass in the
20 wadeable region¹ (mgA m^{-2}); and TOC flux over the criteria unit (mg L^{-1}). The most limiting threshold was
21 used to set the recommendation for the nutrient criteria.

¹ As evaluated through AT2K. The most limiting transect was used in this assessment (i.e., the one that grew the highest mean biomass in the wadeable region). 19 transects considered in total.

1 **Table 13-4. Model simulations to evaluate the relationship between TN and waterbody response.**2 Runs carried out under non-limiting P conditions (i.e., 100 µg L⁻¹).

Criteria Unit 3 – Bighorn River to Powder River (as represented by Forsyth to Powder River in model)										
NO₃- (µg L⁻¹)	TN (µg L⁻¹)	Minimum DO (mg L⁻¹)	DO delta (mg L⁻¹)	pH (max)	pH (max) delta	pH (min)	pH (min) delta	Benthic algae (mg m⁻²)	Benthic algae wadeable zone per AT2K (mg m⁻²)	TOC flux (mg L⁻¹)
6	370	7.28	2.2	8.66	0.00	8.25	0.00	12.7	8.5	0.00
8	422	7.24	2.4	8.75	0.19	8.30	-0.06	24.0	48.2	1.21
10	503	7.24	3.2	8.90	0.34	8.36	-0.18	35.5	68.4	1.99
15	609	7.18	4.2	9.02	0.46	8.39	-0.27	46.3	92.7	2.84
20	679	7.14	4.7	9.07	0.50	8.39	-0.30	52.3	106.8	3.37
25	759	7.11	5.0	9.10	0.54	8.39	-0.33	55.7	116.6	3.75
30	825	7.10	5.3	9.13	0.57	8.41	-0.37	58.2	124.6	3.96
50	948	7.05	5.7	9.17	0.60	8.41	-0.40	63.6	140.9	4.47
70	1120	7.02	6.1	9.20	0.64	8.41	-0.44	65.4	149.6	4.83
100	1284	7.00	6.3	9.23	0.66	8.41	-0.47	67.3	156.7	5.12
Criteria Unit 4 – Powder River to state-line (as represented by Powder River to Glendive in model)										
6	383	7.41	2.1	8.48	0.00	8.22	0.00	8.1	9.2	0.00
8	454	7.29	2.3	8.63	0.17	8.45	-0.08	19.9	53.4	1.38
10	537	7.25	2.7	8.74	0.27	8.56	-0.21	23.6	72.6	2.17
15	648	7.21	3.1	8.83	0.36	8.61	-0.32	24.6	100.8	3.01
20	723	7.19	3.2	8.85	0.40	8.65	-0.37	25.0	116.8	3.51
25	808	7.17	3.4	8.88	0.43	8.69	-0.41	25.4	127.7	3.87
30	876	7.16	3.5	8.91	0.46	8.68	-0.45	26.5	136.8	4.09
50	1011	7.12	3.7	8.97	0.50	8.73	-0.52	95.7	153.3	4.66
70	1181	7.10	3.8	9.00	0.54	8.78	-0.56	100.0	162.9	5.03
100	1355	7.09	3.9	9.03	0.57	8.82	-0.60	103.5	171.9	5.32

3
4
5
6
7
8
9

1 **Table 13-5. Model simulations to evaluate the relationship between TP and waterbody response.**2 Runs carried out under non-limiting N conditions (i.e., 1,000 µg L⁻¹).

Criteria Unit 3 – Bighorn River to Powder River (as represented by Forsyth to Powder River in model)										
SRP (µg L⁻¹)	TP (µg L⁻¹)	Minimum DO (mg L⁻¹)	DO delta (mg L⁻¹)	pH (max)	pH (max) delta	pH (min)	pH (min) delta	Benthic algae (mg m⁻²)	Benthic algae wadeable zone per AT2K (mg m⁻²)	TOC flux (mg L⁻¹)
2	39	7.31	1.83	8.69	0.00	8.33	0.00	14.1	11.6	0.00
3	41	7.31	2.48	8.79	0.12	8.34	-0.04	24.1	40.7	0.93
4	45	7.27	3.31	8.91	0.24	8.38	-0.12	35.1	60.0	1.68
6	54	7.21	4.16	9.01	0.34	8.40	-0.20	44.9	83.3	2.60
8	62	7.17	4.70	9.07	0.40	8.42	-0.26	51.5	97.6	3.09
10	74	7.15	5.06	9.12	0.44	8.43	-0.31	54.9	107.7	3.44
15	88	7.11	5.59	9.17	0.50	8.43	-0.37	60.7	123.5	3.90
20	110	7.08	5.91	9.20	0.53	8.43	-0.40	62.3	132.6	4.36
30	137	7.05	6.28	9.24	0.57	8.43	-0.44	65.0	145.2	4.80
50	170	7.02	6.56	9.26	0.59	8.42	-0.46	66.3	155.9	5.25
Criteria Unit 4 – Powder River to state-line (as represented by Powder River to Glendive in model)										
2	54	7.46	1.57	8.56	0.00	8.31	0.00	4.4	10.5	0.00
3	58	7.34	2.23	8.68	0.07	8.37	-0.07	14.7	45.2	1.06
4	63	7.29	2.62	8.75	0.11	8.47	-0.16	19.0	65.4	1.79
6	74	7.24	2.94	8.83	0.17	8.52	-0.25	22.2	90.5	2.69
8	83	7.22	2.98	8.87	0.15	8.57	-0.25	23.5	105.7	3.16
10	94	7.21	3.20	8.91	0.21	8.62	-0.32	24.1	116.5	3.53
15	110	7.19	3.17	8.96	0.19	8.67	-0.32	25.0	134.8	3.99
20	132	7.18	3.37	8.99	0.23	8.71	-0.38	24.3	145.2	4.45
30	159	7.16	3.77	9.03	0.31	8.75	-0.48	24.1	158.7	4.89
50	195	7.14	4.12	9.06	0.38	8.78	-0.56	23.4	171.1	5.34

3
4
5
6
7
8
9

1 The baseline for each simulation (i.e., against which the additions were subsequently compared) reflect
 2 conditions in the first line of **Table 13-4** and **13-5**. We used the following to determine the soluble
 3 nutrient levels for the baseline: (1) historical low-flow water quality data (**Table 12-5**), (2) the literature
 4 (Meybeck, 1982), and (3) data on streams/rivers elsewhere in the state. We chose soluble N and P
 5 targets of $6 \mu\text{g NO}_3^- \text{ L}^{-1}$ and $2 \mu\text{g SRP L}^{-1}$ as naturally occurring, which align very closely to the lower
 6 measured concentrations in the Yellowstone during 2007 ($3\text{-}6 \mu\text{g NO}_3^- \text{ L}^{-1}$ and $2\text{-}3 \mu\text{g SRP L}^{-1}$). They agree
 7 well with Meybeck (1982) who indicates that unpolluted rivers¹ have concentrations ranging from 20-
 8 $200 \mu\text{g L}^{-1} \text{ NO}_3^-$ and $2\text{-}20 \mu\text{g L}^{-1} \text{ SRP (P-PO}_4\text{)}$, are consistent with Biggs (2000a) who reports similar values
 9 for rivers/streams in New Zealand (slightly lower for soluble nitrogen), and finally match well with
 10 medians ($\approx 5 \mu\text{g L}^{-1}$ for each) for reference streams of the Middle Rockies/Northwestern Great Plains
 11 (Strahler order 4 or greater) as determined by DEQ.

12
 13 Upon initial examination of the model output, there were noted differences in the behavioral response
 14 between the two criteria units. For example in Unit 3, pH was most restrictive to nutrient levels,
 15 whereas benthic algae caused limitation Unit 4. The response in the upper river tells us pH excursions
 16 will likely occur at concentrations $\approx 700 \mu\text{g TN L}^{-1}$ and $\approx 90 \mu\text{g TP L}^{-1}$, indicated by an induced pH change
 17 >9.0 and $\Delta\text{pH} \geq 0.50$ pH units (see **Section 13.3.1** for further explanation). In the lower river,
 18 nutrients should be limited to concentrations of $\approx 1,000 \mu\text{g TP L}^{-1}$ and $\approx 140 \mu\text{g TN L}^{-1}$ to prevent nuisance
 19 algae ($150 \text{ mg Chl}a \text{ m}^{-2}$). An example of how thresholds were established are shown in **Figure 13-3**
 20 (Left/right panel). In general, the river was less responsive to nutrients going downstream.

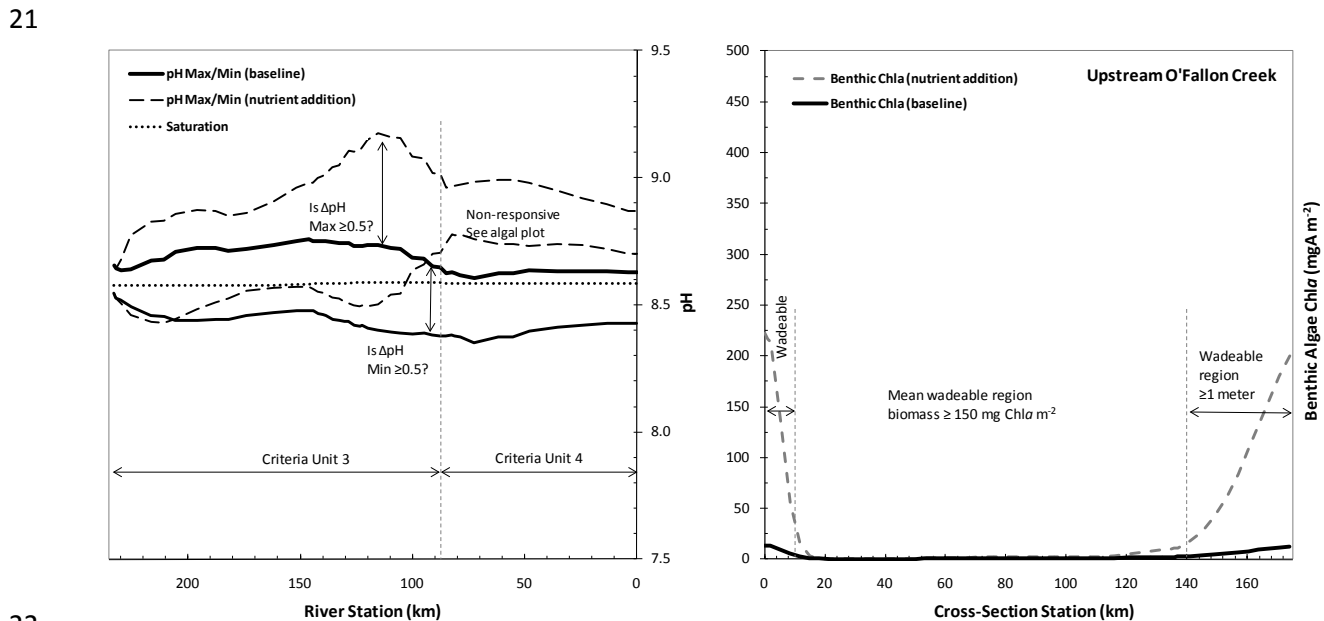

22
 23
 24 **Figure 13-3. Example of a water quality endpoint determination.**
 25 (Left panel) Derivation of pH impairment using the differential between baseline and subsequent nutrient addition
 26 Q2K runs. (Right panel) Same but for benthic algae, considering the wadeable region in AT2K.

¹ Based on an analysis of the arctic, subarctic, and temperate regions of the world.

1 The model outcomes were all non-linear and the response for the most limiting variable in each criteria
 2 assessment areas is shown in **Figure 13-4, Figure 13-5**. Each datapoint reflects one of the ten model runs
 3 in **Table 13-4, Table 13-5** and overall there is a good agreement between the simulated nutrient stressor
 4 and associated waterbody response. The behavioral curve has three distinct regions; a linear lower leg
 5 where changes between nutrients and the response is very sensitive, an inflection point where the
 6 sensitivity to nutrients shifts, and then a less sensitive linear portion where large increases in nutrients
 7 have only a minor effect. Hence tipping-point thresholds exist in the river in relation to nutrient levels
 8 and the associated waterbody response.
 9

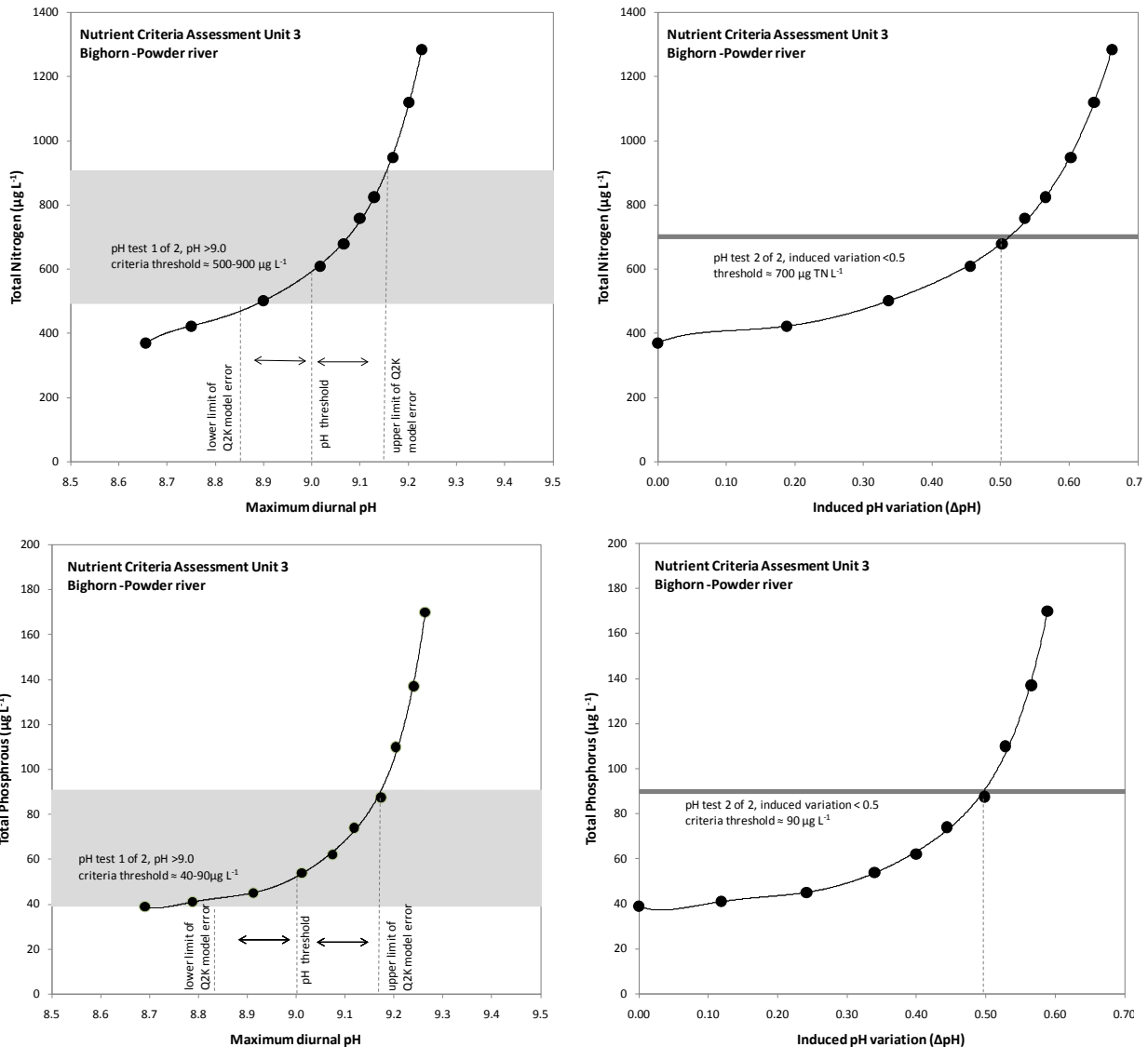

10

11

12 **Figure 13-4. Non-linear response relationship between nutrients and pH.**

13 (Top left/right panel) Most limiting pH response to TN in Criteria Assessment Unit 3 (both maximum diurnal pH and
 14 maximum induced pH variation delta, or ΔpH). (Bottom left/right panel) Same but for TP. Both determinations are
 15 based on a two part test (i.e., pH >9.0 and maximum $\Delta\text{pH} < 0.5$). Existing criteria are shown as the independent
 16 variable (x) and corresponding nutrient concentrations as dependent variable (y). Note: The grey shaded area
 17 reflects the uncertainty in the model prediction based on model errors determined in **Section 10.0**. For ΔpH , there
 18 is no error (i.e., the shift is relative). Criteria are recommended at $\approx 700\ \mu\text{g TN L}^{-1}$ and $\approx 90\ \mu\text{g TP L}^{-1}$ in this region.

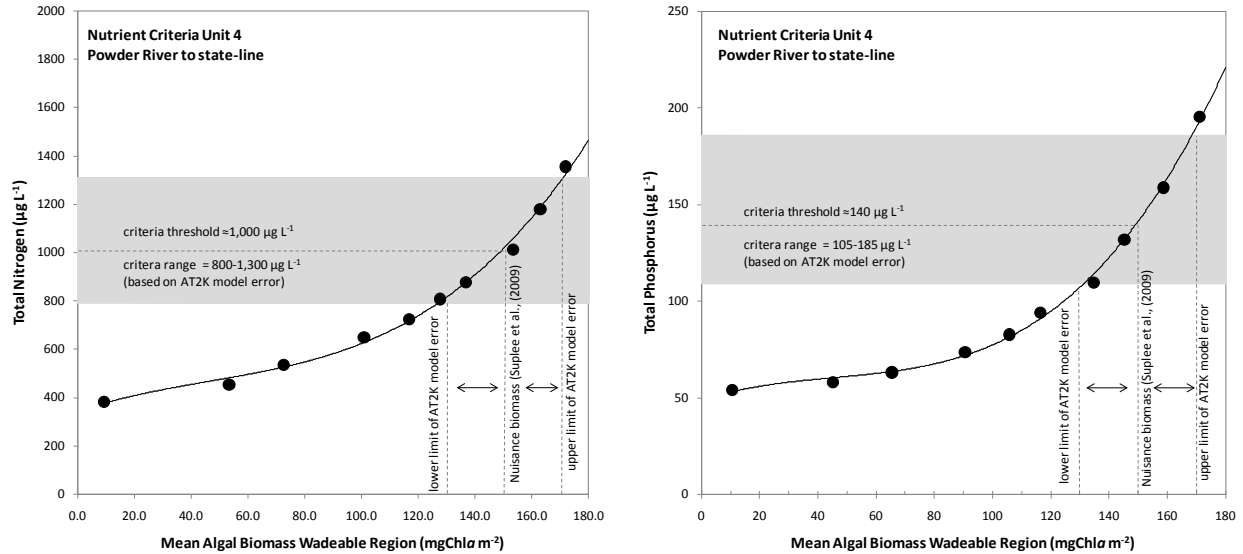

Figure 13-5. Non-linear response relationship between nutrients and benthic algae. (Left panel) Most limiting benthic algae wadeable response to TN in Criteria Assessment Unit 4. (Right panel) Same but for TP. Recreational use biomass thresholds are based on Suplee, et al., (2009) and reflect the mean density in the wadeable zone (see further discussion in **Section 13.3.2**). Existing criteria are shown as the independent variable (x) and corresponding nutrient concentrations as dependent variable (y). Note: The grey shaded area reflects the uncertainty in the model prediction based on model errors determined in **Section 10.0**. TN and TP criteria in Unit 4 are recommended at $\approx 1,000 \mu\text{g TN L}^{-1}$ and $140 \mu\text{g TP L}^{-1}$ in this region.

In review of the previous plots, the non-linear regressions used to interpolate between simulated data provide a reasonable estimate of the criteria. However it is important to note that these have no apparent physical meaning other than fitting the non-linear response curve to the variable of interest. Thus they probably imply better precision than really exists. To acknowledge this fact, thresholds were attained by visual interpolation (with rounding). Thresholds determined for the lower Yellowstone River (and noted previously) are shown in **Table 13-6**.

Table 13-6. Recommended numeric nutrient criteria for the Yellowstone River.

Location	Total Nitrogen ($\mu\text{g L}^{-1}$)	Total Phosphorus ($\mu\text{g L}^{-1}$)
Criteria Assessment Unit 3 Big Horn River to Powder River	700	90
Criteria Assessment Unit 4 Powder River to state-line	1,000	140

13.3 Discussion

Discussions about each of the state-variables considered in the criteria evaluation, including those not used to promulgate criteria, are presented below (i.e., for pH, benthic algae biomass, DO, TOC, total dissolved gas, etc.). They summarize and provide supporting information regarding our conclusions in the previous section.

13.3.1. Nutrient Criteria Based on pH

The segment of the Yellowstone River from Forsyth to the Powder River (Criteria Assessment Unit 3) was found to be most sensitive to pH relative to nutrient additions. Thus some discussion about the Montana pH standard is of merit. The state initially crafted their pH rule after the national pH standards presented in EPA's blue, red, and gold books (EPA, 1972; EPA, 1976; EPA, 1986a). These documents show that the pH standard is a two-part test. Both the shift in pH and induced variation are important. Water quality standards would be exceeded when the induced change is ≥ 0.5 units and the pH is moved outside of the range of 6.0 to 9.0 pH units.

However, this consideration seems to have been lost in translation when the state adopted the pH standard into rule. We say this because ARM 17.30.625 currently indicates any induced variation within the range of 6.5 to 9.0 greater than 0.5 standard units is indicative of impairment. Upon review, we acknowledge that the standard should really reflect a two part test (e.g., >9.0 and ≥ 0.5 induced variation) as pH in the range of 6.5-9.0 is considered harmless to fish (EPA, 1986a) and diurnal changes (Δ) greater than 0.5 are only unacceptable when they push the pH outside the 6.5-9.0 range. Recent reviews of the scientific literature support this assertion (Robertson-Bryan, Inc., 2004) and it has been previously established that warm-water fish populations will be reduced at $\text{pH} > 9.0$ (European Inland Fisheries Advisory Council, 1969) due to the greater prevalence of OH^- ions which cause increased basicity and hypertrophy of mucus cells in gill filaments and skin epithelium, and additional affects on the eye lens and cornea (Alabaster and Lloyd 1980, and Boyd 1990, as cited by Robertson-Bryon 2004).

As a result, we opted to follow the approach recommended by EPA (EPA, 1972; EPA, 1986a) and considered harm-to-use to occur when both (1) the induced pH change was ≥ 0.5 , and (2) when the induced change caused ambient river pH to be > 9.0 . We believe this two-part consideration better satisfies the policy intent and scientific basis of the pH standard.

13.3.2. Nutrient Criteria Based on Benthic Algae Biomass

Benthic algae increased in all nutrient addition scenarios, however, it was only in the lower river that unacceptable algal biomass changes were detected prior to other water quality standards exceedances. This occurred primarily due to light limitation (i.e., there was not a large enough photosynthetic zone to induce pH changes up to a detrimental level). Hence benthic algae in the wadeable zone of the lower river were identified as the primary driver for establishing the nutrient limits in this area.

Levels of benthic algae in excess of $150 \text{ mg Chl}a \text{ m}^{-2}$ have been demonstrated to be an unacceptable impediment to river recreation in Montana (Suplee et al. 2009) and we carried this information forward through this work. For example, survey respondents from the Miles City area showed preference for river algae levels $\leq 150 \text{ mg Chl}a \text{ m}^{-2}$ (Table 6; Suplee et al., 2009), but sample size was small ($n = 13$) and not all preference levels were significantly different from 50%. A similar and significant response was received from the Billings area, which means that maintaining river algae below nuisance levels of $150 \text{ mg Chl}a \text{ m}^{-2}$ is a reasonable water quality endpoint and is important to people living and recreating along the lower Yellowstone River. It is also consistent with a number of past literature studies where biomass of $100\text{-}200 \text{ mg m}^{-2} \text{ Chl}a$ was determined to be nuisance (Dodds, et al., 1997; Dodds and Welch, 2000; Welch, et al., 1988).

1 In our case however, direct application of $150 \text{ mgChl}a \text{ m}^{-2}$ to the entire river is not appropriate as light
2 gradients predispose the river to luxuriant algal growth only in shallow regions of the river whereas the
3 remaining sections of the river are strongly light limited and are not productive (see **Figure 2-2** in
4 **Section 2.2.1**). It would be very difficult then (if not impossible) to observe a reach-average biomass in
5 excess of $150 \text{ mg Chl}a \text{ m}^{-2}$. Therefore the most relevant nutrient control policy would be to limit biomass
6 in the wadeable region of the river where recreation occurs (i.e., wading, fishing, tubing, canoeing,
7 swimming, etc.). An observer must pass through, or directly use the wadeable zone, to gain benefit from
8 the river and thus we require the mean biomass in this region to be $\leq 150 \text{ mgChl}a \text{ m}^{-2}$.

9
10 Since previous work already defined this wadeable zone for larger rivers¹ (Flynn and Suplee, 2010), our
11 work only required integration of biomass over the wadeable region such that average of this zone is
12 $\leq 150 \text{ mgChl}a \text{ m}^{-2}$. Thus the highest algal biomasses will occur directly nearshore and then will quickly
13 taper off toward the channel thalweg (note: this is different than “no sample shall exceed”). Overall, 20
14 transect locations were evaluated within the river to understand this process (**Table 13-7**). The most
15 limiting transect (i.e., the one that had the largest algal response and that achieved the most nuisance
16 conditions²) was used in formulation of the criteria. We only considered cross-sections where
17 approximately 25% or greater of the overall transect width was wadeable in our final criteria
18 determination (i.e., a good proportion of the river bed would be affected).

19
20 A further consideration with respect to benthic algae biomass is the uncertainty owed to collection and
21 analytical measurement. DEQ has evaluated this construct in our wadeable streams program and has
22 concluded that a stream whose mean benthic algae level is measured and found to be $\geq 129 \text{ mgChl}a \text{ m}^{-2}$
23 could plausibly have a true benthic algae level at or above nuisance (Suplee and Sada de Suplee, 2011).
24 Likewise, replicate measurements in the wadeable zone of large rivers indicate that we can be 80%
25 confident that the measured mean algal Chl a is within $\pm 30\%$ of the true mean (DEQ, 2011b). Given
26 similar variability, and the fact that the RMSE identified in the model itself approaches this same error,
27 we chose to use the directly simulations of benthic algae. We recognize that error in our estimate could
28 go either direction (as shown in **Figure 13-5**), but that our modeled value is the most expected value.

¹ Wadeable depth defined as 1 meter. This is the depth that roughly corresponds to the force where a person could still wade and not be over-toppled by the oncoming water force.

² The sections surveyed are believed to encompass typical variability in the river. However, only a subset of very long river reaches were evaluated (n =approximately 10 in each reach). Thus the most-limiting cross-section was used towards to make an appropriate determination of nutrient thresholds to restrict algal biomass accumulations at that site to $<150 \text{ mgChl}a \text{ m}^{-2}$. It was determined that mean wadeable depth explained most of the variance in the wadeable and cross-sectional biomass average ($r^2=0.93$) and only the transect with the shallowest mean wadeable depth required evaluation.

1 **Table 13-7. Locations of benthic biomass evaluation and most limiting transect.**

Location	% Wadeable	Mean Wadeable Depth
Criteria Assessment Unit 3		
Meyers Bridge	29.1	0.78
Forsyth Bridge	21.9	0.64
Far West FAS	58.6	0.49
Paragon Bridge	67.3	0.57
Keough Bridge	16.8	0.56
Hwy 59 Bridge	38.8	0.51
Pirogue Island	65.1	0.52
Kinsey Bridge	63.6	0.52
US Powder River	21.0	0.36 ¹
Criteria Assessment Unit 4		
US Calypso Bridge	43.4	0.32
Calypso Bridge	12.1	0.43
Terry Bridge	26.8	0.56
US O'Fallon Creek	24.4	0.30 ¹
Fallon Bridge	30.0	0.45
Glendive RR Bridge	01.4	0.11
Glendive Bell St. Bridge	12.3	0.34
Glendive I-94 Bridge	09.5	0.53
Sidney Bridge	15.6	0.48
Fairview Bridge	09.3	0.42

2 ¹Most limiting cross-section to biomass response based on mean wadeable depth
3

4 **13.3.3. Dissolved Oxygen Effects**

5
6 From analysis of DO in the model, it is highly unlikely that DO minima in the river will ever reach the
7 minimum 5 mg L⁻¹ threshold. A number of physical factors support this conclusion including: (1) the
8 presence of the Cartersville Diversion Dam which is a reaeration source, (2) high reaeration rates of the
9 river itself, (3) low river SODs, and (4) the fact that much of the bed of the river lies deep below the
10 surface and is unsuitable for aquatic plant growth. Historical data tends to support this assertion as even
11 during times of heavy historical pollution, there has never been a documented DO minima downstream
12 of Forsyth¹ [at least during short term river surveys (Knudson and Swanson, 1976; Montana Board of
13 Health, 1956; Peterson, et al., 2001)]. Consequently, we can only foresee DO being a potential problem
14 in two circumstances: (1) if a very large BOD source were to be permitted in the future (which, based on
15 state and federal laws, will not occur) or (2) if excess benthic algal accumulation during the summer

¹ Billings (upstream) is the exception, and several exceedances have occurred there (Montana Board of Health, 1956; Peterson, et al., 2001).

1 months influences the river's DO in the fall when algae die *en masse* during senescence. This was
2 observed by DEQ during a whole-stream fertilization study in eastern Montana¹.

3
4 The DO demand from algal decomposition is a valid concern² as decomposition consumes oxygen. To
5 evaluate this consideration, we used some very conservative assumptions regarding the immediate
6 oxidation of algal organic material within the model with an assumed BOD source equal to the maximum
7 areal biomass observed in the river. Assuming 150 mgChl a m⁻² average cross-sectional biomass (or 16.1
8 gC m⁻²), the expected DO demand would be 43.0 gO₂ m⁻² day⁻¹ for river depths of 1 m, which was input
9 to Q2K directly as a prescribed SOD³. Simulations indicate even a source of this magnitude has negligible
10 impact on DO. In fact, DO minima barely fell below 7 mgO₂ L⁻¹. Thus this consideration is not valid for
11 the Yellowstone River and no further consideration of DO was completed.
12

13 **13.3.4. Total Organic Carbon and Disinfection Byproducts**

14
15 TOC levels were also evaluated to ensure that treatment level thresholds for carcinogenic disinfection
16 byproducts (DBPs) would not be exceeded. Through our model simulations, it became apparent TOC
17 levels in the river were perhaps too vague of an endpoint to develop nutrient criteria upon. First, we had
18 difficulty identifying treatment and/or filtration costs associated with their removal, projecting those
19 estimates into the future for some hypothetical design capacity of the water treatment plants, and
20 finally were confused about gray areas regarding DBP treatment limits. Even so, it appears as if TOC is
21 not an important model endpoint. In all model trials, TOC flux was never much over 5.0 mg L⁻¹ for the
22 entire river and only marginally induced a change outside of the categorical treatment level of <4-8 mg
23 L⁻¹ TOC suggested by EPA that would require permittees to increase the percentage of TOC removal.
24

25 **13.3.5. Total Dissolved Gas (TDG)**

26
27 State law requires that induced TDG remain below 110% of saturation (**Table 4-3**) to protect fish from
28 gas bubble disease. However, the standard is mainly intended to control super-saturation of
29 atmospheric gas below dam spillways, for example, whereas in the Yellowstone River gas
30 supersaturation is driven predominantly by diel DO changes. A thorough literature review on gas
31 supersaturation effects on fish (Weitkamp and Katz, 1980) shows that fish are tolerant of much higher
32 total gas levels than the state's standard when the gas pressure is being driven by oxygen. For example,

¹ The whole-stream nutrient-addition study was completed on a wadeable 5th order stream in Eastern Montana (DEQ, 2010). Based on our observations, dissolved oxygen impacts from excess nutrients were out of phase with the period of peak algal production, in fact they occurred entirely after the growing season as algae senesced *en masse*. The decaying material settled in the low-velocity regions of the stream resulting in localized areas of high CBOD which effectively acted like an intense sediment oxygen demand (Appendix B; Suplee and Sada de Suplee, 2011).

² In several instances we saw large mats of dead and dying benthic algae washed onto the banks of the river, however, there was no apparent influence on DO based on our sonde data.

³ The SOD 43.0 gO₂ m⁻² day⁻¹ was about two times higher than the highest river SOD we were able to locate in the literature [21.4 gO₂ m⁻² day⁻¹; (Ling, et al., 2009)].

1 fish have been found to tolerate DO saturation levels to 300% DO without manifesting the disease.
2 Further, when the supersaturation effect is intermittent, as it is in the Yellowstone River, the negative
3 impact on fish is greatly reduced. DO supersaturation levels observed in our model runs were never
4 greater than 175% of saturation and were therefore not an endpoint of consideration with respect to
5 gas bubble disease in the river's fish.
6

7 **13.4 Summary**

8
9 A number of plausible nutrient criteria endpoints were evaluated through model analysis and it was
10 identified that pH was the most sensitive nutrient-influenced water quality endpoint in Criteria Unit 3
11 (upstream; model boundary to the Powder River) whereas it was benthic algae in Criteria Unit 4
12 (downstream; Powder River to state line). The difference between the two regions was primarily light
13 availability (i.e., suspended fines mute primary productivity in the lower river) which necessitated
14 different criteria. Recommended nutrient criteria then are 700 $\mu\text{g TN L}^{-1}$ and 90 $\mu\text{g TP L}^{-1}$ in Unit 3 and
15 1,000 $\mu\text{g TN L}^{-1}$ and 140 $\mu\text{g TP L}^{-1}$ in Unit 4. Model results also showed a non-linear response to nutrients.
16 There is generally an initial phase where water quality parameters change quickly with the addition of a
17 nutrient, followed by an inflection point, and then a less-responsive phase where additional nutrients
18 alter the water quality parameters only slightly. The nutrient addition simulation runs presented in this
19 section represent the endpoint of our modeling work on the lower Yellowstone River. Uncertainty
20 regarding these simulations is detailed in the next section and then we conclude with final
21 recommendations for the sections of the river evaluated.
22
23
24
25

14.0 UNCERTAINTY ANALYSIS

Following the identification of approximate nutrient criteria thresholds for the Yellowstone, an uncertainty analysis was completed to better understand the implications of these findings and prescribe a defensible margin of safety for the final criteria recommendations. The details of the uncertainty analysis follow.

14.1 Error-Propagation Methods

Some information regarding error-propagation and uncertainty is necessary to understand the context of its importance to our modeling results. Uncertainty is an inherent part of natural systems and includes such things as spatial temporal variability in water quality as well as uncertainty related to the model. Analysis of such information has therefore assumed a growing importance in the field of water quality management (Beck, 1987; Brown and Barnwell, 1987; Reckhow, 2003; Vandenberghe, et al., 2007; Whitehead and Young, 1979) and is recommended in ecological modeling studies (Chapra, 2003; Reckhow, 1994; Reckhow, 2003).

Uncertainty in water quality models can generally be grouped into three separate categories: (1) uncertainty about the relationships in the model or model structure, (2) uncertainty about the value of model parameters or rate coefficients, or (3) uncertainty associated with prediction of the future behavior of the system (Beck, 1987). In this application, we are primarily interested in the latter two components, and how they interrelate to form the overall error in model simulations.

To characterize this uncertainty, error-propagation techniques were used to quantitatively express the reliability of modeling results beyond the statistical evaluations presented in **Section 9.0** (i.e., observed vs. simulated state-variable comparisons). This then will account for the inevitable complexity of the model provide underlying meaning to the significance of our work (Whitehead and Young, 1979). Uncertainty can be readily characterized by the following steps (Vandenberghe, et al., 2007):

1. Identifying the sources that are felt to most contribute to the overall uncertainty of the modeling. (We have already done this through our sensitivity analysis in **Section 9.1**).
2. Estimating the uncertainty related to those main contributors and underlying assumptions (i.e., distribution, etc. as outlined in this section).
3. Propagating the uncertainty through the model (described later).
4. Analyzing results.

The most simple technique for determining the reliability of model predictions and accounting for the sources of uncertainty in model inputs and related parameters is Monte Carlo simulation. Ours is described in the next section.

14.2 Monte Carlo Simulation

Monte Carlo simulation (MCS) is a class of computational algorithm that relies on repeated random sampling to compute a statistical result about a model output. It is a way to numerically manipulate a modeling system to address uncertainty so that that combined effects of parameter sensitivity and uncertainty are considered (Melching and Yoon, 1996). Input variables are sampled at random from

1 their pre-determined probability distributions (or cumulative density functions; CDF) and the
 2 distribution of the output variable is reviewed to yield a new probability distribution of model outcomes.
 3 While a large number of model runs is required (i.e., repeated simulations) to make such
 4 determinations, the changes in uncertain model parameters using random selections from their
 5 assumed or estimated probability distributions reflects the cumulative uncertainty of the model
 6 (Whitehead and Young, 1979). A number of probability density functions (PDF) for model input can be
 7 specified (e.g. normal, log-normal, triangular, uniform, etc.), and then numerous model runs are
 8 executed using the PDF for which model outcomes for which the CDF of the output variable(s) of
 9 interest is generated. In our case, the CDF will be for the proposed nutrient criteria (TN and TP). This
 10 sampling process is shown graphically in **Figure 14-1**, with several hypothetical model parameter
 11 distributions (normal, uniform, and triangular).

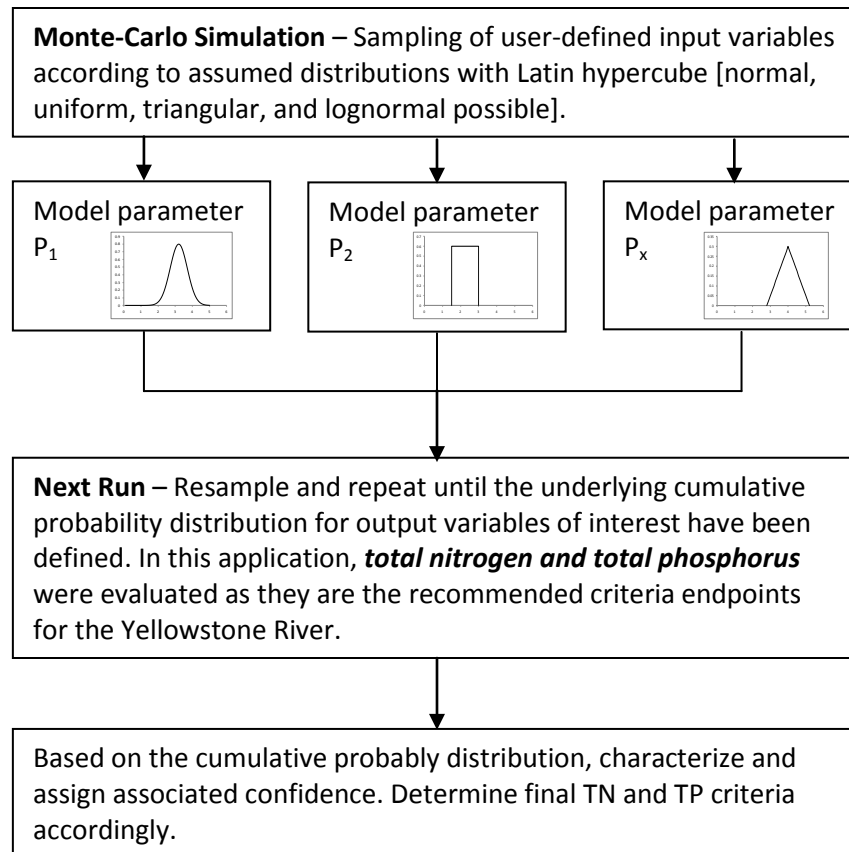

38 **Figure 14-1. Example of Monte Carlo simulation procedure for Yellowstone River.**

40 **14.3 Estimates of Uncertainty in the Yellowstone River Q2K Model**

42 Four types of uncertainty were considered as part of our MCS:

- 43 • Uncertainty in the headwater boundary condition
- 44 • Uncertainty in point source pollutants (tributaries/WWTPs)
- 45 • Uncertainty in diffuse source pollutants
- 46 • Uncertainty in model parameters/rate coefficients

1 The analysis was carried out using a version of Q2K called QUAL2K-UNCAS. This was developed as part of
 2 a cooperative effort between Tufts University and DEQ (Tao, 2008). It is essentially an update of the
 3 original QUAL2E-UNCAS (Brown and Barnwell, 1987). Improvements made to the model included the
 4 incorporation of Latin Hypercube sampling strategies instead of that of random sampling (McKay, et al.,
 5 1979) and added CDF selections for the perturbed rates or input variables (including uniform and
 6 triangular).

7
 8 As identified by others (Beck, 1987; Brown and Barnwell, 1987; Reckhow, 1994; Vemula, et al., 2004),
 9 the most important consideration in MCS is characterizing the uncertainty in model inputs. This includes
 10 characterization of their probability density function (PDF) shape (i.e., normal, lognormal, uniform,
 11 triangular, etc.) and associated coefficient of variation or relative standard deviation (COV).
 12 Unfortunately, such information is not widely available (Brown and Barnwell, 1987). As a result, we did
 13 our best to estimate distributions and COVs from historical field and water quality data. We then used
 14 the literature and engineering/scientific judgment in the absence of such data.

15
 16 Uncertainty estimates for the Yellowstone River are shown in **Tables 14-1, 14-2, 14-3, 14-4**. They
 17 generally fall within the range identified by others (Brown and Barnwell, 1987; Manache, et al., 2000;
 18 Melching and Yoon, 1996; Vandenberghe, et al., 2007; Vemula, et al., 2004).

19
 20 **Table 14-1. PDF assignments for headwater boundary conditions of the Yellowstone River.**

21 Distributions determined primarily from low-flow data compilation described in **Section 12.0**.

Parameter	Units	Min	Avg	Max	Distribution	Coefficient of Variation (COV) (%)	Literature range ²
Flow	m ³ s ⁻¹	93.65	98.58	103.5	n/a	5 ¹	5
Temperature	°C	18.0	21.8	26.0	normal	10	1-8
Conductivity	µS cm ⁻¹	590	714	945	normal	15	1-15
Inorganic solids ³	mgD L ⁻¹	15	25	47	normal	50	n/a
Dissolved oxygen	mgO ₂ L ⁻¹	7.5	8.9	9.6	normal	10	2-15
CBODfast	mgO ₂ L ⁻¹	8.8	9.4	9.9	normal	15	5-40
Organic-N	µg L ⁻¹	not evaluated since already perturbed as part of nutrient addition scenarios detailed in Section 13.0 .					
Ammonia-N	µg L ⁻¹						
Nitrate-N	µg L ⁻¹						
Organic-P	µg L ⁻¹						
Dissolved-P	µg L ⁻¹						
Phytoplankton	µg L ⁻¹						
Internal-N	mgN mgA ⁻¹						
Internal-P	µg L ⁻¹						
Detritus ³	mgD L ⁻¹	2.8	4.7	8.9	normal	50	n/a
Alkalinity	mgCaCO ₃ L ⁻¹	129	152	170	normal	10	n/a
pH	pH units	8.3	8.6	8.9	normal	5	n/a

22 ¹ To be consistent with 14Q10, included approximate variation between 14Q10 between gages.

23 ² From the following: (Brown and Barnwell, 1987; Manache, et al., 2000; Melching and Yoon, 1996;
 24 Vandenberghe, et al., 2007; Vemula, et al., 2004).

25 ³ ISS based on TSS * 0.8; detritus based on TSS * 0.2 (same distribution and COV assumed)

26 n/a = not available

1 As shown previously, distribution types at the headwater boundary condition would be normal provided
 2 that the analysis was constrained to low-flow conditions. COVs were low¹ ($\leq 15\%$, with the exception of
 3 ISS and detritus), and most values were within the range reported in the literature. This reaffirms that
 4 water quality is not greatly variable during uncharacteristically low-flow conditions. As indicated in the
 5 table, N or P loading variance was not considered so that undue variance in model output was not
 6 increased over that of the initial nutrient addition scenarios (i.e., evaluations were contingent on a
 7 specific concentration of nutrients in the river and any alteration of the load would change the
 8 subsequent concentration and associated outcome). The point load variance was slightly higher (**Table**
 9 **14-2**), but still within the ranges identified in the literature. This was expected given that tributaries are
 10 generally flashy and have high natural variance.

11

12 **Table 14-2. PDF assignments for point loads on the Yellowstone River.**

13 Distribution determined primarily from database described in **Section 6.0** (August data only).

Parameter	Units	Min ¹	Avg ²	Max ¹	Distribution	Coefficient of Variation (COV) (%)	Literature range ³
Flow	m ³ s ⁻¹	0	---	7.439	n/a	0 ⁴	n/a
Temperature	°C	10	---	29	normal	10	1-8
Conductivity	μS cm ⁻¹	428	---	3,920	lognormal	5	1-15
Inorganic solids ⁵	mgD L ⁻¹	1.0	---	20,610	lognormal	35	n/a
Dissolved oxygen	mgO ₂ L ⁻¹	3.9	---	17.1	normal	25	2-15
CBODfast	mgO ₂ L ⁻¹	2.8	---	21.6	lognormal	60	5-40
Organic-N	μg L ⁻¹	not evaluated since already perturbed and considered as part of nutrient addition scenarios detailed in Section 13.0 .					
Ammonia-N	μg L ⁻¹						
Nitrate-N	μg L ⁻¹						
Organic-P	μg L ⁻¹						
Dissolved-P	μg L ⁻¹						
Phytoplankton	μg L ⁻¹						
Internal-N	mgN mgA ⁻¹						
Internal-P	μg L ⁻¹						
Detritus ⁶	mgD L ⁻¹	0.1	---	2,160	lognormal	35	n/a
Alkalinity	mgCaCO ₃ L ⁻¹	142	---	461	normal	35	n/a
pH	pH units	6.8	---	8.7	normal	5	n/a

14 ¹ Minimum and maximum taken from lumped pool of point load data evaluated.

15 ² Mean not shown as is dependent on individual point load.

16 ³ From the following: (Brown and Barnwell, 1987; Manache, et al., 2000; Melching and Yoon, 1996;
 17 Vandenberghe, et al., 2007; Vemula, et al., 2004).

18 ⁴ Flow was not altered to maintain a 14Q10 streamflow condition in the river.

19 ⁵ ISS based on TSS * 0.9 (same distribution and COV assumed)

20 ⁶ Detritus based on TSS * 0.1 (same distribution and COV assumed)

¹ This is at least partially a function of the sample size (n=10), which may also reflect apparent normality.

1 Tributary flow had the largest COV (i.e., 135%), but was not considered in the analysis given our
 2 requirement to maintain and approximate 14Q10 condition within the river. An example PDF of point
 3 load uncertainties are shown in **Figure 14-2 (Left/Right panel)** for water temperature and total
 4 suspended solids (as a surrogate for ISS and detritus). In each instance, the normal and natural logarithm
 5 (lognormal) distribution best fit the histograms observed data¹.
 6

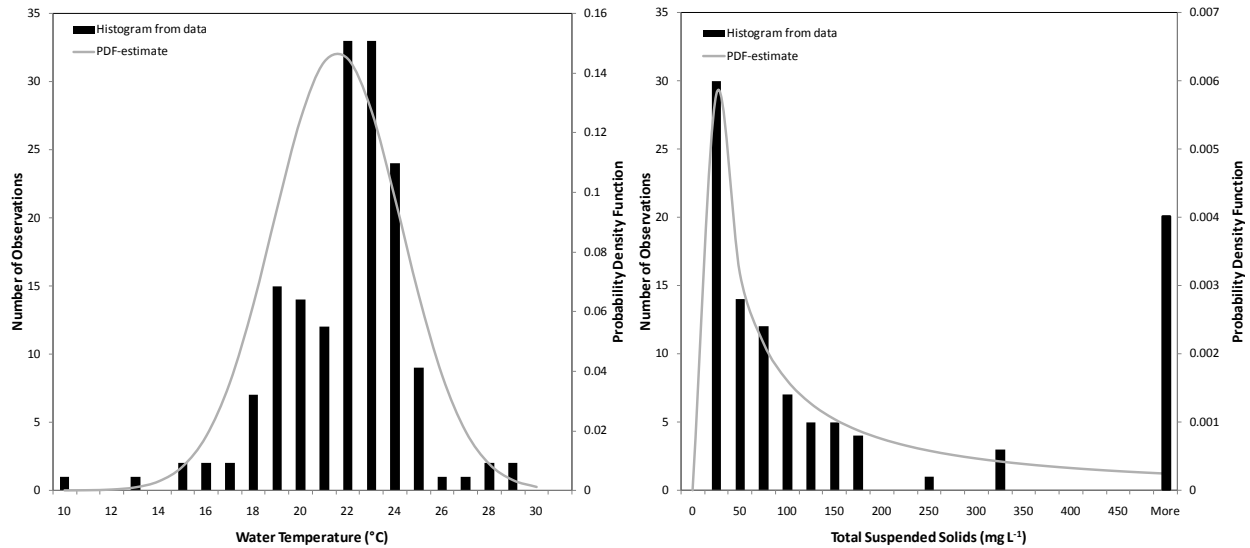

7
8
9 **Figure 14-2. Example point load PDF used in Yellowstone River Monte Carlo Analysis.**

10 (Left panel) Normal PDF for water temperature point load to the Yellowstone River. (Right panel) Same but
 11 lognormal distribution (natural logarithm) for total suspended solids.

12
 13 Diffuse boundary conditions were difficult to estimate. For example, groundwater inputs are relatively
 14 constant whereas irrigation return flows and the diffuse tributary inflows are highly variable. We used
 15 the database from **Section 6.0** to estimate the lumped relative uncertainty of these data². Overall
 16 diffuse source COVs for the Yellowstone River were slightly higher than point load estimates (**Table 14-**
 17 **3**) which reflects their uncertain nature. There was no apparent change in the distribution type from
 18 that of the point source loads, only an increase in the variance.

19
 20
¹ We made only visual comparisons of the histogram to determine the proposed underlying input
 distribution and then fit those data with the appropriate pdf. The normal distribution was defined as

$$\frac{1}{\sqrt{2\pi\sigma^2}} e^{-\frac{(x-\mu)^2}{2\sigma^2}}$$
 and the lognormal distribution was $\frac{1}{x\sqrt{2\pi\sigma^2}} e^{-\frac{(\ln x-\mu)^2}{2\sigma^2}}$, where μ =mean and σ^2 =variance
 of the variable x 's normal or natural logarithm respectively.

² We are bound by QUAL2K-UNCAS software limitations which allows only a single average variance for
 all of the diffuse inflows into the model (i.e., all diffuse sources are treated as having the same
 uncertainty even though the sources may be distinctly different). Thus a lumped analysis is necessary.

1 **Table 14-3. PDF assignments for diffuse loads on the Yellowstone River.**
 2 Distribution determined primarily from database described in Section 6.0 (August data only).

Parameter	Units	Min ¹	Avg ²	Max ¹	Distribution	Coefficient of Variation (COV) (%)	Literature range ³
Flow	m ³ s ⁻¹		---		n/a	0 ⁴	n/a
Temperature	°C	9.1	---	34	normal	20	1-8
Conductivity	µS cm ⁻¹	493	---	6,970	lognormal	5	1-15
Inorganic solids ⁵	mgD L ⁻¹	0.3	---	35,382	lognormal	75	n/a
Dissolved oxygen	mgO ₂ L ⁻¹	3.5	---	12.7	normal	20	2-15
CBODfast ⁶	mgO ₂ L ⁻¹	n/a	---	n/a	lognormal	30	5-40
Organic-N	µg L ⁻¹	not evaluated since already perturbed and considered as part of nutrient addition scenarios detailed in Section 13.0.					
Ammonia-N	µg L ⁻¹						
Nitrate-N	µg L ⁻¹						
Organic-P	µg L ⁻¹						
Dissolved-P	µg L ⁻¹						
Phytoplankton	µg L ⁻¹						
Internal-N	mgN mgA ⁻¹						
Internal-P	µg L ⁻¹						
Detritus ⁷	mgD L ⁻¹	0	---	3,931	lognormal	75	n/a
Alkalinity	mgCaCO ₃ L ⁻¹	122	---	1,818	normal	40	n/a
pH	pH units	4.4	---	9.1	normal	10	n/a

3 ¹ Minimum and maximum taken from lumped pool of point load data evaluated.

4 ² Mean not shown as is dependent on individual point load.

5 ³ From the following: (Brown and Barnwell, 1987; Manache, et al., 2000; Melching and Yoon, 1996; Vandenberghe, et al., 2007; Vemula, et al., 2004).

7 ⁴ Flow was not altered to maintain a 15Q10 streamflow condition in the river.

8 ⁵ ISS based on TSS * 0.9 (same distribution and COV assumed)

9 ⁶ Limited BOD data (n=5), assume same distribution as point loads, use calculated

10 ⁷ Detritus based on TSS * 0.1 (same distribution and COV assumed)

11
 12 Model rate coefficient uncertainty was a final consideration. This type of uncertainty has been the
 13 primary focus in a number of literature studies (Brown and Barnwell, 1987; Dilks, et al., 1992; Manache,
 14 et al., 2000; Melching and Yoon, 1996; Reckhow, 2003; Stow, et al., 2007; Vandenberghe, et al., 2007;
 15 Vemula, et al., 2004), but unfortunately most of the specified variances in these studies stem from a
 16 single source (Brown and Barnwell, 1987)¹. Consequently we made an attempt to better describe
 17 parameter uncertainty specific to our river.

18
 19 Previously either normal distributions (de Azevedo, et al., 2000; Melching and Yoon, 1996; Vemula, et
 20 al., 2004), or triangular or lognormal distributions (Manache, et al., 2000) were applied. We generally

¹ Both laboratory and field calibration studies are available to make generalized estimates of uncertainty, however, these have a wide range of outcomes and inconsistent results.

1 followed suit, but with an informal Bayesian inference methodology. The approach was completed in
 2 the spirit of Hornberger and Spear (1980) as reviewed by Dilks, et al. (1992), Reckhow and Chapra
 3 (1999), and Stow, et al., (2007). In these studies, the literature was first used to provide an estimate of
 4 plausible ranges for a given parameter of interest, and then site-specific observations of model state-
 5 variable were relied on to narrow that range of acceptable or unacceptable parameter ranges from
 6 posteriori model evaluations. Depending on whether the model gave a behavior generating response
 7 [i.e., a response that somewhat reflects the observed data structure, (Dilks, et al., 1992; Stow, et al.,
 8 2007)] or a nonbehavior generating response (where the response was beyond acceptable limits), the
 9 allowable range was narrowed.

10
 11 The analysis was completed manually by moving inward from the initial literature array until posteriori
 12 determinations suggested the parameter in question had shifted from the nonbehavior generating
 13 region to a behavior generating response. An example of this is shown in **Figure 14-3** and was
 14 determined through evaluation of all of the model's state-variables. We did not consider parameter
 15 covariances in this determination which means independence between model parameters was assumed
 16 (which we know is not totally true, but necessary). Our recommended distributions, ranges, and the
 17 associated COVs for the Yellowstone River MCS are shown in **Table 14-4**.

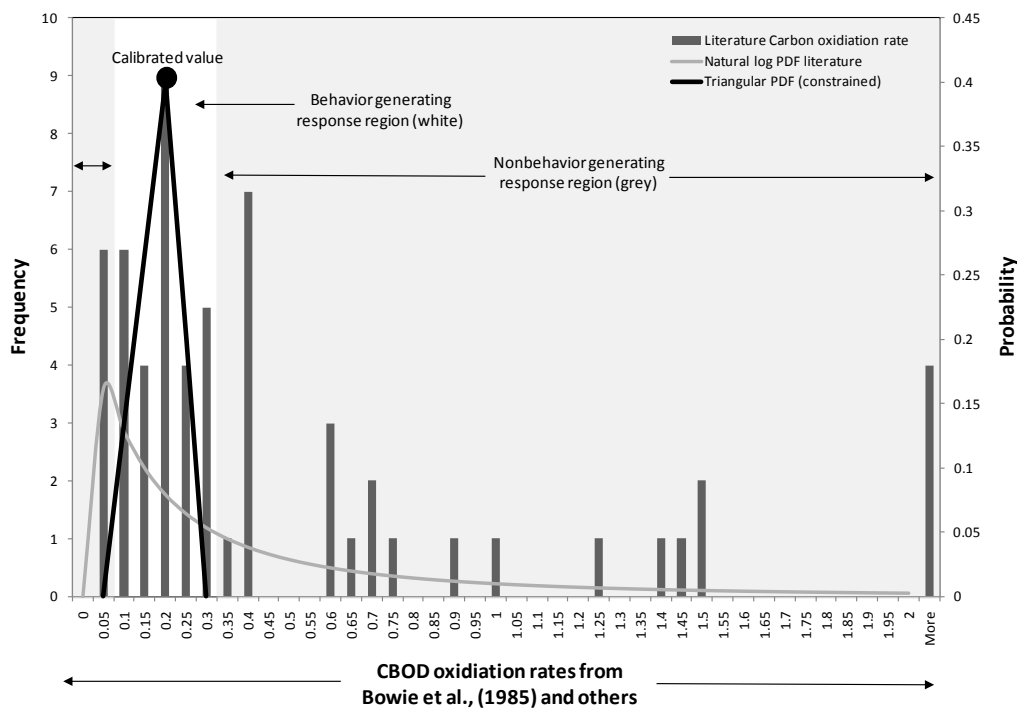

19
 20
 21 **Figure 14-3. Example PDF assignment for model rate coefficients on the Yellowstone River.**

22 The $CBOD_{fast}$ oxidation rate illustrates how the parameter space (and distribution) was first defined using the
 23 literature and then was refined using Bayesian principles/posteriori analysis of model runs to identify behavior
 24 generating response and non-behavior generating response regions for the MCS. A triangular PDF was then fit to
 25 these ranges. In the case of CBOD oxidation rate, the PDF approximated a normal distribution. Others are more
 26 lognormally distributed.

Table 14-4. PDF assignments for rate coefficients for the Yellowstone River.

Distributions determined as noted in table footnote.

Parameter	Units	Min/Max from Bayesian Inference ¹			Distribution	Coefficient of Variation (COV) (%)
		Min	Avg/Mode	Max		
Stoichiometry:²						
Carbon	STOCARB	35	43	53	normal	10
Nitrogen	STO NTR	3.7	4.7	4.9	normal	10
Phosphorus	STOPHOS	1.0	1.0	1.0	n/a	n/a
Dry weight	STODRYW	87	107	134	normal	60
Chlorophyll	STOCHLOR	0.4	0.4	1.0	normal	35
CBOD _{fast} oxidation rate	FBODDECA	0.05	0.2	0.3	triangular	n/a
Nitrogen Rates:³						
OrgN hydrolysis rate	NH2 DECA	0.05	0.1	0.3	triangular	
Org N settling velocity	NH2 SETT	0.01	0.05	0.1	uniform	n/a
Nitrification rate	NH3 DECA	0.1	2.5	10	triangular	n/a
Denitrification rate	NO3 DENI	0	0.1	2.0	triangular	n/a
Phosphorus Rates:³						
OrgP hydrolysis rate	PORG HYD	0.05	0.1	0.3	triangular	n/a
OrgP settling velocity	PORG SET	0.01	0.05	0.1	uniform	n/a
SRP settling velocity	DISP SET	0	0.012	0.1	uniform	n/a
Phytoplankton Rates:^{3,4}						
Max growth rate	PHYT GRO	1.7	2.3	2.5	normal	15
Respiration rate	PHYT RES	0.01	0.2	0.5	normal	50
Excretion rate	PHYT EXA	n/a	n/a	n/a	not used	n/a
Death rate	PHYT DET	0.01	0.15	0.25	triangular	n/a
External N half sat constant	PHYNFACT	5	40	200	triangular	n/a
External P half sat constant	PHYFACT	5	12	100	triangular	n/a
Light constant	PHYLFACT	30	60	90	triangular	n/a
Ammonia preference	PHYFPNH3	5	20	30	uniform	n/a
Subsistence quota for N ^{5,6}	PHYTQTAN	1.7	2.5	5.9	normal	15
Subsistence quota for P ^{5,6}	PHYTQTAP	0.06	0.1	0.19	normal	15
Maximum uptake rate for N	PHYT MAXN	10	40	75	triangular	n/a
Maximum uptake rate for P	PHYT MAXP	15	27	50	triangular	n/a
Internal N half sat constant ^{5,6}	PHYFACTN	1.7	2.5	5.9	normal	15
Internal P half sat constant ^{5,6}	PHYFACTP	0.03	0.05	0.10	normal	15
Settling velocity	PHYT SETT	0	0.05	1	triangular	n/a
Bottom Algae Rates:²³						
Max growth rate	BALG GRO	300	400	500	normal	20
Respiration rate	BALG RES	0.01	0.2	0.5	normal	20
Excretion rate	BALG EXA	n/a	n/a	n/a	not used	n/a
Death rate	BALG DET	0.2	0.3	0.4	triangular	n/a
External N half sat constant	BALNFACT	10	250	750	triangular	n/a
External P half sat constant	BALPFACT	30	125	200	triangular	n/a
Light constant	BALLFACT	30	60	90	triangular	n/a

Table 14-4. PDF assignments for rate coefficients for the Yellowstone River.

Distributions determined as noted in table footnote.

Parameter	Units	Min/Max from Bayesian Inference ¹			Distribution	Coefficient of Variation (COV) (%)
		Min	Avg/ Mode	Max		
Ammonia preference	BALPFNH3	5	20	30	uniform	n/a
Subsistence quota for N ^{5,6}	BALGQTAN	1.7	3.2	5.9	normal	15
Subsistence quota for P ^{5,6}	BALGQTAP	0.06	0.13	0.19	normal	15
Maximum uptake rate for N	BALG MAXN	10	35	150	triangular	n/a
Maximum uptake rate for P	BALG MAXP	3	4	15	triangular	n/a
Internal N half sat constant ^{5,6}	BALFACTN	1.7	3.2	5.9	normal	15
Internal P half sat constant ^{5,6}	BALFACTP	0.02	0.04	0.06	normal	15
Detritus:³						
Dissolution rate	POM DISL	0.05	0.25	0.5	triangular	n/a
Settling velocity	POM SETT	0	0.05	1	triangular	n/a

1 ¹The literature range was identified from review of Bowie et al., (1985) as well as others (Auer and
2 Canale, 1982a; Biggs, 1990; Borchardt, 1996; Bothwell, 1985; Bothwell, 1988; Bothwell and Stockner,
3 1980; Chapra, 1997; Chaudhury, et al., 1998; Cushing, et al., 1993; Di Toro, 1980; Drolc and Koncan,
4 1999; Fang, et al., 2008; Hill, 1996; Horner, et al., 1983; Kannel, et al., 2006; Klarich, 1977; Knudson and
5 Swanson, 1976; Lohman and Priscu, 1992; Ning, et al., 2000; Park and Lee, 2002; Peterson, et al., 2001;
6 Rutherford, et al., 2000; Shuter, 1978; Stevenson, 1990; Tomlinson, et al., 2010; Turner, et al., 2009; Van
7 Orden and Uchrin, 1993; Watson, et al., 1990). ² Determined from multiple seston measurements in
8 summer of 2007 (n=15)

9 ³ Minimum and maximum taken from the literature range initially and then refined through Bayesian
10 inference [see (Dilks, et al., 1992; Reckhow and Chapra, 1999; Stow, et al., 2007)].

11 ⁴ From light-dark bottle experiments in August 2007 (n=4); min/max not temperature corrected.

12 ⁵ COV for subsistence quota calculated from Shuter (1978).

13 ⁶ According to Di Toro (1980) these values have very strong covariance with one another and were
14 evaluated as such.

15

16 14.4 Uncertainty Propagation

17

18 The uncertainty analysis was implemented through propagation of the load and parameter uncertainty
19 constraints described in the previous section. We used the nutrient addition scenario corresponding to
20 the recommendations in **Section 13.2**, where induced pH change was greater than 9.0 and pH delta ≈0.5
21 at a target TN and TP criteria of 700 and 90 µg L⁻¹ in the upper river, and benthic algal biomass in the
22 wadeable region was limiting in the lower river at concentrations of 1,000 and 140 µg L⁻¹. From review of
23 the literature, it appears as if 1,000-2,000 model runs are sufficient to established acceptable model
24 output PDF (Brown and Barnwell, 1987; Jehng-Jung and Bau, 1995; Melching and Yoon, 1996; Vemula,
25 et al., 2004), and consequently, we used a simulation of 2,000 runs in our analysis (n=2,000). Sampling of
26 the PDF was completed using Latin Hypercube sampling

27

28

14.5 Results

The results of the uncertainty analysis are shown in **Figure 14-4**. They were unexpected. Overall, the variance in output for TN and TP is small, and grows in the downstream direction. This is attributed to several factors including our decision to not perturbate nutrient loads in the analysis (i.e., they had already been fixed in the nutrient addition scenarios), the fact that rate uncertainties are less important to total nutrients than individual species (i.e., rates govern cycling between pools but still sum to the total), and finally that Bayesian inference techniques were used to narrow the range of allowable rate distributions from the broader literature array (thereby decreasing the allowable range in computed criteria). Consequently, even under worst case conditions we believe the proposed criteria to be constrained to the following ranges:

- Upper river: 700 ± 13 TN L⁻¹ and 90 ± 2 TP L⁻¹
- Lower river: $1,000 \pm 37$ μ g TN L⁻¹ and 140 ± 5 μ g TP L⁻¹ in each criteria unit.

Values reflect the mean deviation between computed upper and lower limits of possible Monte Carlo outcomes and the maximum uncertainty in a given reach (which as shown was at the most downstream point in each criteria unit). Computed 90% confidence intervals (CI) were also tabulated, but were so low that we did not report them. We acknowledge that the uncertainty analysis is not without limitation, but is useful in understanding the relative magnitude of the potential uncertainty associated with our recommendations.

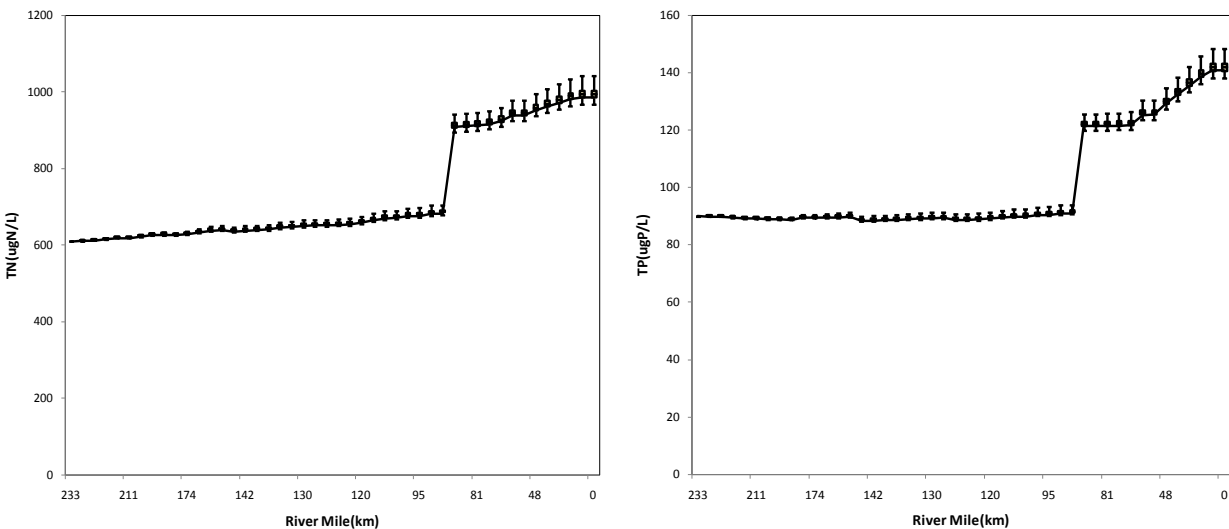

Figure 14-4. Estimated model output variance around computed criteria.

(Left panel). Suggested output variance for TN. (Right panel). Same but for TP. The 25th, 50th, and 75th percentiles are shown in the figure along with the minimum and maximum computed value. The relatively small variance is related to the decision did not perturbate nutrient loads as part of the uncertainty analysis (i.e., they were already iterated as part of the nutrient addition scenarios). The Monte Carlo output distributions tended more towards the higher (right skewed) results as of most of the rate parameters had right skewed triangular input distributions.

15.0 COMPARISONS WITH OTHER NUTRIENT CRITERIA METHODS

Non-modeling or empirical methods for nutrient criteria development were also reviewed in conjunction with the mechanistic analysis to develop an understanding of nutrient, algae, DO, and pH relationships from the literature (as well as ecoregional numeric nutrient criteria recommendations from EPA). Additionally, some of the limited historical data on the lower Yellowstone River were used to construct nutrient-algae relationships as suggested in the EPA recommended approach. The results of these comparisons are presented below.

15.1 Criteria Recommendations from the Literature

There is growing consensus regarding nutrient thresholds and responses, and appropriate strategies for numeric nutrient criteria development (Dodds and Welch, 2000; Snelder, et al., 2004; Suplee, et al., 2007; EPA, 2000b). In many of these efforts, total nitrogen (TN) and phosphorus (TP) concentrations are proposed to minimize nuisance algal growth, dissolved oxygen deficiencies, or other undesired water quality responses. Concentrations are on the order of 300-3000 $\mu\text{g TN L}^{-1}$ and 20-300 $\mu\text{g TP L}^{-1}$ according to the peer-reviewed studies in **Table 15-1**.

Proposed limits tend to be in agreement with values suggested for western Montana, and in some cases, were specifically developed for the area [e.g., the voluntary criteria recommendations for the Clark Fork River (Dodds, et al., 1997) or percentile based approaches for wadeable streams in Montana (Suplee, et al., 2007)]. However, the applicability of these studies toward larger and more turbid rivers, specifically the Yellowstone River, is debatable due to the differences outlined in **Section 2.0**.

Table 15-1. Examples of numeric nutrient criteria in the literature.

Author(s)	Location	Outcome or Recommendations
Dodds, et al., (1997)	Montana, USA and data from 200 rivers worldwide	Mean targets of 350 $\mu\text{g TN L}^{-1}$ and 30 $\mu\text{g TP L}^{-1}$ total to keep benthic biomass $\leq 150 \text{ mg Chl } a \text{ m}^{-2}$
Appendix A of Suplee, et al., (2008)	Wadeable plains streams in the northern plains regions of eastern Montana	Suggested criterion of 1,120 $\mu\text{g TN L}^{-1}$ to assure maintenance of dissolved oxygen levels above 5.0 mg L^{-1} (i.e., the state DO water quality standard)
Sheeder and Evans (2004)	Pennsylvania, USA	Suggested criteria of 2,010 $\mu\text{g TN L}^{-1}$ and 70 $\mu\text{g TP L}^{-1}$ based on data compilation from watersheds where biological uses were attained
Dodds and Welch (2000)	Multiple locations, USA and New Zealand	Suggests criteria of 250-3000 $\mu\text{g TN L}^{-1}$ and 20-415 $\mu\text{g TP L}^{-1}$ to limit benthic algae $< 200 \text{ mg Chl } a \text{ m}^{-2}$, limits for oxygen deficit and pH excursion unknown
Biggs (2000b)	Periphyton Guidelines for New Zealand	1.0-26.0 $\mu\text{g SRP L}^{-1}$ and 10-295 $\mu\text{g L}^{-1}$ soluble inorganic nitrogen (SIN) in order to maintain benthic algal growth in wadeable streams and rivers to no more than 120-200 $\text{mg Chl } a \text{ m}^{-2}$ and 35 g AFDM m^{-2} . Author indicates that criteria should be chosen within the ranges based on the likely number of days that will pass between

Table 15-1. Examples of numeric nutrient criteria in the literature.

Snelder, et al., (2004)	Mesotrophic rivers on the South Island, New Zealand	Proposed criteria of 59.8 $\mu\text{g L}^{-1}$ soluble inorganic nitrogen (SIN) and 5.7 $\mu\text{g L}^{-1}$ soluble reactive phosphorus (SRP) to keep benthic biomass <200 mg Chl α m $^{-2}$
Dodds, et al. (Dodds, et al., 2006; 1996)	Multiple locations, USA and New Zealand	Saturation points in nutrient-algal biomass correlations are identified. Above the saturation point, algal biomass is not likely to be controlled; thus, the saturation points represent potential criteria. These were 27 $\mu\text{g TP L}^{-1}$ and 367 $\mu\text{ TN L}^{-1}$.

1

2

15.2 Ecoregional Recommendations from EPA

3

4

5

6

7

8

9

10

Table 15-2. Level III ecoregion ambient water quality criteria recommendations.

Nutrient Parameters ¹	Northwestern Great Plains	Middle Rockies	Wyoming Basin
Total Nitrogen ($\mu\text{g L}^{-1}$)	560	120	380
Total Phosphorus ($\mu\text{g L}^{-1}$)	23	10	22

11

12

13

14

15.3 Historical Nutrient-Algae Relationships on the Yellowstone River

15

16

17

18

19

20

21

22

23

24

Historical nutrient-algae data were also compiled for the lower river (i.e., Forsyth to Sidney) to identify the relationship between water column nutrient concentration and algal biomass. Results indicate that amount of information available to make such determinations is sparse (i.e., very infrequent biomass monitoring), and that nutrient concentrations generally increase in the downstream direction without associated changes in algal density. Ambient water quality concentrations also rarely meet the N & P ecoregional criteria recommendations. Hence, either the small number of samples evaluated on the Yellowstone River is too small, or the proposed ecoregional criteria are inadequate.

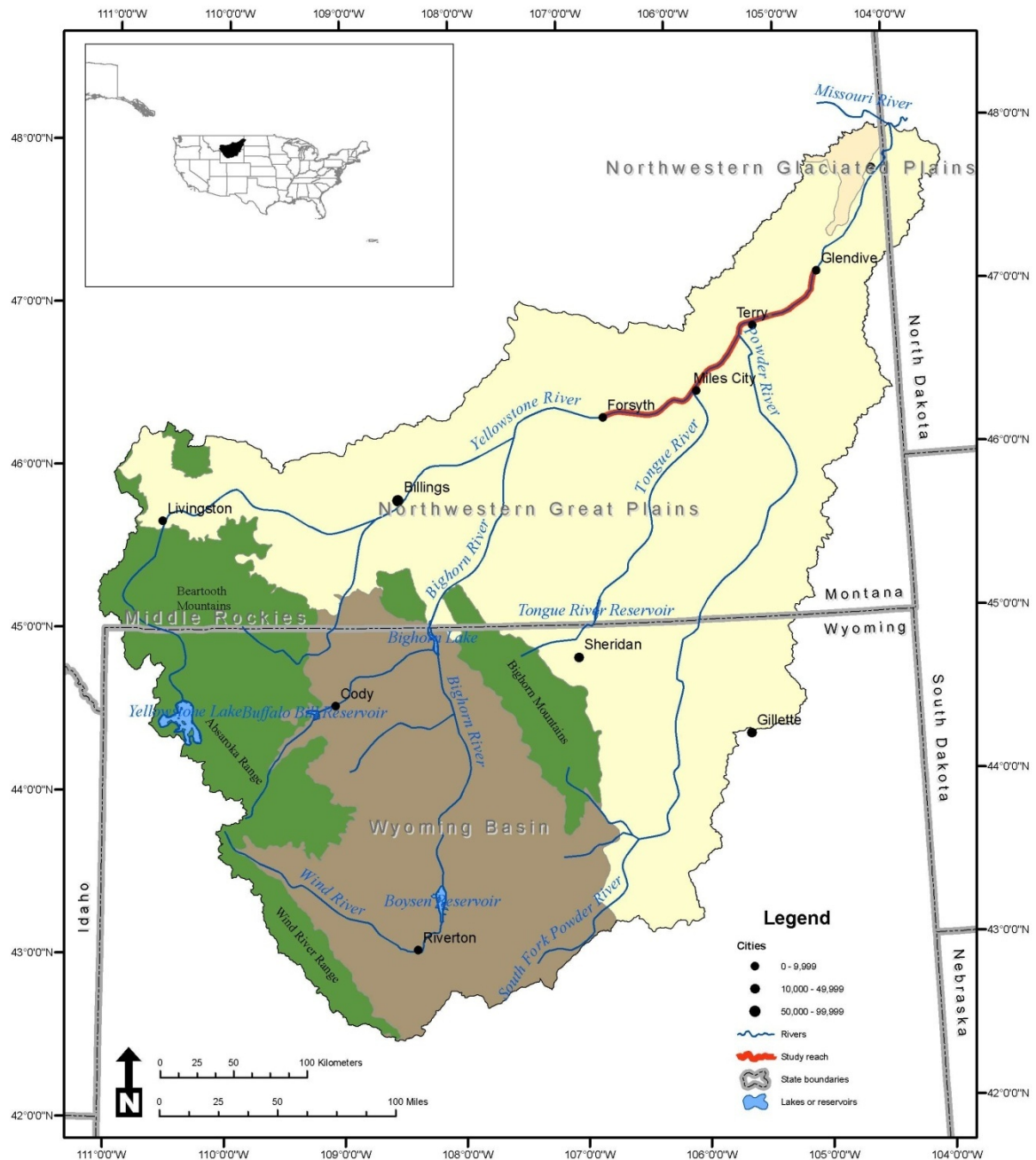

1
2 **Figure 15-1. Level III ecoregions in relation to water quality criteria recommendations.**

3 The study reach is located in the center of the Northwestern Great Plains ecoregion. However, much of the water
4 flowing into the river actually originates from the Middle Rockies and Wyoming Basin and ecoregion. Hence it is
5 difficult to determine which criteria recommendations from **Table 14-2** should really apply to the section in
6 question.

7
8 From the paired nutrient-algae data that were available on the lower river (i.e., Forsyth to Sidney, within
9 the same week during the low-flow August- September period) we found that TN and TP explain 34%
10 and 1% of the variance in benthic biomass. When extrapolated to a concentration reflective of nuisance

1 biomass (as defined by 150 mg Chl *a* m⁻²), threshold nutrient concentrations would be 505 µg L⁻¹ of TN
 2 and 45 µg L⁻¹ of TP to limit nuisance algae (**Figure 15-2**). This excludes data in the shallower reaches of the
 3 river near Billings and Laurel, and also does not consider the differences in USGS and DEQ collection
 4 methodologies (Porter, et al., 1993).

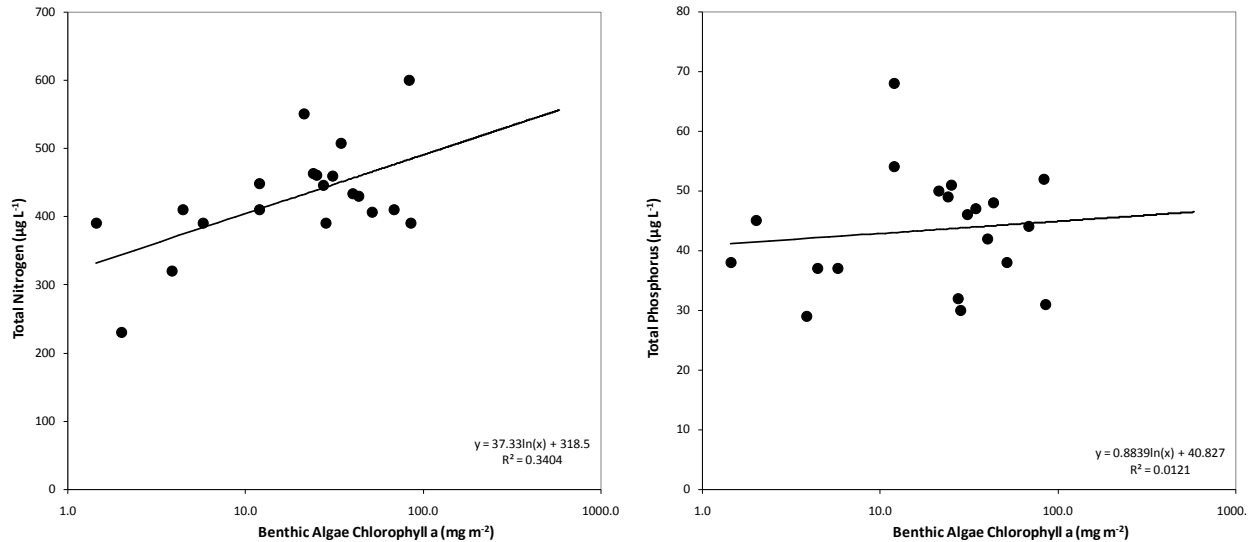

6
 7 **Figure 15-2. Relationship between nutrients and benthic biomass on the lower Yellowstone River.**

8 (Left panel) Relationship between TN and benthic algae. (Right panel) Same but for TP. Data shown for the months
 9 of August and September (data from Forsyth to Sidney, MT).

10
 11 Clearly coefficients of determination (r^2) for the regressions are poor, which is typical as correlation
 12 coefficients between river nutrient concentrations and benthic algal biomass are usually no better than
 13 about 0.4 (Dodds et al. 1996; Chetelat et al. 1999; Dodds 2006; Dodds 2007). This stems partly from the
 14 noise of the actual field and analytical techniques, and more so from the fact that the life cycles of
 15 benthic algae (growth, death, and senescence) is variable and can greatly alter the total nutrients in
 16 aquatic settings over very short period. Thus, these correlations should only be used as initial estimates.
 17 Interestingly, the result are very comparable to the ecoregional recommendations and illustrates the
 18 difficulty in using regression analysis to describe patterns between two variables whose linkage are not
 19 conservative relative to one another.

21 15.4 Summary of Findings

22
 23 Three independent methods were used to provide comparative estimates of numeric nutrient criteria
 24 endpoints for the lower Yellowstone River. This included a review of nutrient, algae, DO, and pH
 25 relationships from the scientific literature, ecoregional recommendations from EPA, and analysis of
 26 historical nutrient-algae relationships on the river itself. Generally, there are a large range of plausible
 27 outcomes for which criteria could potentially exist, which is further confounded by limitations such as
 28 available data, spatial transferability, and uncertainty in data methods.

29
 30 A matrix of these outcomes is presented in **Table 15-3**, which collectively illustrate the need for the
 31 modeling study and the apparent difference that can result when using site specific, as opposed to large
 32 dataset empirical approximations.

1 **Table 15-3. Summary of outcomes from varying approaches to assess numeric nutrient criteria.**
 2 Recommendations for the lower Yellowstone River.

Source	TN Outcome ($\mu\text{g L}^{-1}$)	TP Outcome ($\mu\text{g L}^{-1}$)
Literature range	300-3000	20-300
Level III ecoregional recommendation	560	23
Historical nutrient-algae data	514	43
Site-specific water quality model¹	700 / 1,000	90 / 140

3 ¹Big Horn River to Powder River / Powder River to state-line, respectively
 4

5 **15.5 Expert Elicitation Regarding Findings**

6
 7 A number of recognized regional and national technical experts were consulted for additional input
 8 regarding the data compilation assessment, as well as the modeling. Those who provided expert
 9 elicitation are shown in **Table 15-4** and their input has been integrated into the overall outcome.
 10 Individual reviewer comments are provided in **Appendix D**.
 11

12 **Table 15-4. Expert review panel solicited for input regarding Yellowstone River nutrient criteria.**

Name	Expertise	Affiliation	Location
Dr. Steven Chapra	Water quality modeling	Tufts University	Boston, MA
Dr. Don Charles	Phycology	Academy of Natural Sciences	Philadelphia, PA
NSTEPS and other reviewers	Please fill in when you complete your review. Thank you.	?	?

13

1

16.0 SUMMARY

An alternative approach toward numeric nutrient criteria development was established via this project. It consisted of: (1) use of mechanistic water quality models to determine the stressor-response relationship between nutrients and key water quality endpoints (DO, pH, benthic algae, etc.), (2) derivation of nitrogen and phosphorus criteria endpoints for a large river using those tools, (3) evaluations of whether modeled criteria are consistent with other nutrient endpoint techniques, and (4) compilation of our findings such that other States or Tribes can make informed decisions about large rivers in their regions.

The work was completed on a 232.9 km segment of the Yellowstone River in eastern Montana from Forsyth to Glendive, MT (Waterbody ID MT42K001_010 and MT42M001_012). In this region, we developed criteria for two distinct areas: (1) the Bighorn River to the Powder River (for which our model characterizes approximately half of the reach); and (2) Powder River to state-line (which has a similar extent). In this section of the lower Yellowstone River (other large rivers may be similar), different water quality parameters led to different nitrogen and phosphorus criteria. The distinction comes from longitudinal changes in river variables like depth, turbidity and light.

In the upper and less turbid reaches of the lower Yellowstone River (Forsyth to Powder River), river pH proved to be the most sensitive water quality variable. An induced pH shift >9.0 and diurnal change ≥ 0.50 indicated impairment. Thus in this region a large proportion of the river could respond photosynthetically to increased nutrients. The lower river was less sensitive and thereby nearshore nuisance algae (<150 mg Chl a m^{-2}) were most important. Both QUAL2K and AT2K were essential in making these determinations. DEQ subsequently comes to recommend that criteria be set at 700 $\mu\text{g TN L}^{-1}$ and 90 $\mu\text{g TP L}^{-1}$ from the Big Horn River to the Powder River confluence, and $1,000$ $\mu\text{g TN L}^{-1}$ and 140 $\mu\text{g TP L}^{-1}$ from the Powder River confluence to state line to prevent unacceptable variation in pH or nuisance algae. The results were found to be significant at the 90% confidence level.

Findings were also compared with existing information in the literature to identify the applicability of the estimate in the context of previous studies. Because the Yellowstone River is deep and moderately turbid/light limited, our criteria recommendations are higher than typically suggested for wadeable streams and rivers in either the scientific literature, or from the EPA. This is a function of two factors. First, the criteria found in the literature were mainly developed for wadeable streams which are shallow. Secondly, these systems are typically less turbid than larger rivers. Hence light-limitation was an important component of this study and we integrated its effect into river management. Such a consideration makes the transfer of empirical approaches not tenable, and the use of mechanistic models very appealing.

Finally, we recognize that despite our best efforts, the criteria in this document are imperfect. Uncertainty is inherent within all water resource systems, embedded within the science and engineering we use to describe them. We have acknowledged and quantified this uncertainty to the extent possible. This was done through error analysis and implementation of modeling best-management practices. However, this does not preclude the possibility that such criteria may need to be re-visited in the future. We are fortunate enough in this instance that we will have the opportunity to analyze water quality data, do model post-audits, and adjust management objectives over time (if necessary) as the river moves closer to the suggest criteria. Only as we observe these changes will the validity of our estimates be truly apparent.

1

17.0 REFERENCES

- 1
2
3 Administrative Rules of Montana. 1999. Surface Water Quality Standards and Procedures. State of
4 Montana. Helena, MT: Secretary of State. Report 17.30.601-17.30.646.
- 5 American Public Health Association, American Water Works Association, and Water Environment
6 Federation. 2005. Standard Methods for the Examination of Water and Wastewater, 21 ed..
- 7 American Society for Testing and Materials. 1984. Standard Practice for Evaluating Environmental Fate
8 Models of Chemicals. Philadelphia, PA. Report Designation E978-84.
- 9 ----- . 2011. Terrestrial Reference Spectra for Photovoltaic Performance Evaluation.
10 <http://rredc.nrel.gov/solar/spectra/am1.5/>. Accessed 2/17/11.
- 11 Andreen, W. L. 2004. Water Quality Today - Has the Clean Water Act Been a Success? *Alabama Law*
12 *Review*. 55(2004): 537-593.
- 13 Applied Geomorphology, Inc. and DTM Consulting, Inc. 2004. Geomorphic Reconnaissance and GIS
14 Development Yellowstone River, Montana: Springdale to the Missouri River Confluence: Final
15 Report. Applied Geomorphology, Inc. and DTM Consulting, Inc. Custer County Conservation
16 District.
- 17 Arhonditsis, G. B. and M. T. Brett. 2004. Evaluation of the Current State of Mechanistic Aquatic
18 Biogeochemical Modeling. *Marine Ecology Progress Series*. 271(2004): 13-26.
- 19 Army Corps of Engineers. 2003. Upper Mississippi River Flow Frequency Study. Omaha District. Report
20 Hydrology and Hydraulics Appendix F Missouri River.
21 <http://www.mvr.usace.army.mil/pdw/pdf/FlowFrequency/Documents/FinalReport/Reports/App%20F%20Omaha%20Dist/App%20F%20Omaha%20Dist.%20Hydrology%20&%20Hydraulics%20Report.pdf>.
22
23
- 24 Auer, M. T. and R. P. Canale. 1982a. Ecological Studies and Mathematical Modeling of Cladophora in
25 Lake Huron: 3. The Dependence of Growth Rates on Internal Phosphorus Pool Size. *Journal of*
26 *Great Lakes Research*. 8(1): 93-99.
- 27 ----- . 1982b. Ecological Studies and Mathematical Modeling of Cladophora in Lake Huron: 3. The
28 Dependence of Growth Rates on Internal Phosphorus Pool Size. *Journal of Great Lakes Research*.
29 8(1): 93-99.
- 30 Bahls, L. L. 1974. Microflora of the Yellowstone River: Microflora in the Plankton at the Confluence of
31 the Bighorn River: Preliminary Report to the Montana Dept. of Fish and Game, Environment and
32 Information Division. Helena, MT: Environmental Quality Council.

- 1 ----- 1976a. Microflora of the Yellowstone River II: Perturbations Through Billings: Prepared for
2 Presentation at the 36th Annual Meeting of the Montana Academy of Sciences. Helena, MT:
3 Environmental Quality Council.
- 4 ----- 1976b. Microflora of the Yellowstone River III: The Non-Diatom Algae. Helena, MT: Environmental
5 Quality Council.
- 6 Bakema, A. H. 1988. Empirical Light Modeling for a Number of Dutch Lakes. The Netherlands (in Dutch).
7 Report Delft Hydraulics Report T387.
- 8 Baly, E. C. C. 1935. The Kinetics of Photosynthesis. *Proceedings of the Royal Society B*. 117: 218-239.
- 9 Barnwell, T. O., L. C. Brown, and W. Mareck. 1989. Application of Expert Systems Technology in Water
10 Quality Modeling. *Water Science and Technology*. 21(8-9): 1045-1056.
- 11 Barnwell, T. O., L. C. Brown, and R. C. Whittemore. 2004. Importance of Field Data in Stream Water
12 Quality Modeling Using QUAL2E-UNCAS. *Journal of Environmental Engineering*. 130(6): 643-647.
- 13 Barthalow, J. M. 1989. Stream Temperature Investigations: Field and Analytic Methods. Instream Flow
14 Information Paper No. 13. U.S. Fish Wildlife Service Biol. Report. Report 89(17).
- 15 Basu, B. K. and F. R. Pick. 1995. Longitudinal and Seasonal Development of Planktonic Chlorophyll *a* in
16 the Rideau River, Ontario. *Canadian Journal of Fisheries and Aquatic Sciences*. 52(1995): 804-
17 815.
- 18 ----- 1996. Factors Regulating Phytoplankton and Zooplankton Biomass in Temperate Rivers. *Limnology
19 and Oceanography*. 41(7): 1572-1577.
- 20 ----- 1997. Phytoplankton and Zooplankton Development in a Lowland Temperature River. *Journal of
21 Plankton Research*. 19(2): 237-253.
- 22 Bayley, S. E., I. F. Creed, G. Z. Sass, and A. S. Wong. 2007. Frequent Regime Shifts in Trophic States in
23 Shallow Lakes on the Boreal Plain: Alternative "Unstable" States? *Limnology and Oceanography*.
24 52(5): 2002-2019.
- 25 Beck, M. B. 1987. Water Quality Modeling: A Review of the Analysis of Uncertainty. *Water Resources
26 Research*. 23(8): 1393-1442.
- 27 Benke, Arthur C. and Colbert E. Cushing. 2005. Rivers of North America, 1st edition ed., Elsevier
28 Academic Press. Accessed 6/8/09.
- 29 Berglund, O. 2003. Periphyton Density Influences Organochlorine Accumulation in Rivers. *Limnology and
30 Oceanography*. 48(6): 2106-2116.

- 1 Berglund, O., P. Larsson, L. Bronmark, A. E. Greenberg, and L. Okla. 1997. Factors Influencing
2 Organochlorine Uptake in Age-0 Brown Trout (*Salmo Trutta*) in Lotic Environments. *Canadian*
3 *Journal of Fisheries and Aquatic Sciences*. 54: 2767-2774.
- 4 Biggs, B. J. F. 1990. Use of Relative Specific Growth Rates of Periphytic Diatoms to Assess Enrichment of
5 a Stream. *New Zealand Journal of Marine and Freshwater Research*. 24: 9-18.
- 6 ----- 1996. "Patterns in Benthic Algae of Streams," in *Algal Ecology, Freshwater Benthic Ecosystems*,
7 Stevenson, R. Jan, Bothwell, M. L., and Lowe, R. L., (San Diego, CA: Academic Press): 31-76.
- 8 ----- 2000a. Eutrophication of Streams and Rivers: Dissolved Nutrient-Chlorophyll Relationships for
9 Benthic Algae. *Journal of the North American Benthological Society*. 19: 17-31.
- 10 ----- 2000b. New Zealand Periphyton Guideline: Detecting, Monitoring and Managing Enrichment of
11 Streams, Christchurch, New Zealand: NIWA. [http://www.mfe.govt.nz/publications/water/nz-](http://www.mfe.govt.nz/publications/water/nz-periphyton-guide-jun00.html)
12 [periphyton-guide-jun00.html](http://www.mfe.govt.nz/publications/water/nz-periphyton-guide-jun00.html).
- 13 ----- 2000c. Stream Periphyton Monitoring Manual. Christchurch, NZ: NIWA, New Zealand Ministry of
14 the Environment. http://www.mfe.govt.nz/withyou/funding/docs/5092_periphytonmanual.pdf.
- 15 Blom, G., E. H. S. Van Duin, and L. Lijklema. 1994. Sediment Resuspension and Light Conditions in Some
16 Shallow Dutch Lakes. *Water Science and Technology*. 30: 243-252.
- 17 Borchardt, M. A. 1996. "Nutrients," in *Algal Ecology-Freshwater Benthic Ecosystems*, Stevenson, R. Jan,
18 Bothwell, M. L., and Lowe, R. L., (San Diego, CA: Academic Press): 183-227.
- 19 Bothwell, M. L. 1985. Phosphorus Limitation of Lotic Periphyton Growth Rates: An Intersite Comparison
20 Using Continuous-Flow Troughs (Thompson River System, British Columbia). *Limnology and*
21 *Oceanography*. 30(3): 527-542.
- 22 ----- 1988. Growth Rate Responses of Lotic Periphytic Diatoms to Experimental Phosphorus Enrichment:
23 The Influence of Temperature and Light. *Canadian Journal of Fisheries and Aquatic Sciences*. 45:
24 261-270.
- 25 ----- 1989. Phosphorus-Limited Growth Dynamics of Lotic Periphytic Diatom Communities: Areal
26 Biomass and Cellular Growth Rate Responses. *Canadian Journal of Fisheries and Aquatic*
27 *Sciences*. 46: 1293-1301.
- 28 Bothwell, M. L. and J. G. Stockner. 1980. Influence of Secondarily Treated Kraft Mill Effluent on the
29 Accumulation Rate of Attached Algae in Experiment Continuous-Flow Troughs. *Canadian Journal*
30 *of Fisheries and Aquatic Sciences*. 37: 248-254.
- 31 Bowie, G. L., W. B. Mills, D. B. Porcella, C. L. Campbell, J. R. Pagenkopf, G. L. Rupp, K. M. Johnson, P. W.
32 H. Chan, S. Gherini, and C. E. Chamberlin. 1985. Rates, Constants, and Kinetics Formulations in

- 1 Surface Water Quality Modeling (Second Edition). Athens, GA: United States Environmental
2 Protection Agency. Report EPA/600/3-85/040.
- 3 Box, G. E. P. and N. R. Draper. 1987. Empirical Model-Building and Response Surfaces: Wiley.
- 4 Boyd, M. and B. Kasper. 2003. Analytical Methods for Dynamic Open Channel Heat and Mass Transfer:
5 Methodology for the Heat Source Model Version 7.0.
6 <http://www.deq.state.or.us/wq/TMDLs/tools.htm>.
- 7 Brown, L. C. and T. O. Barnwell. 1987. The Enhanced Stream Water Quality Models QUAL2E and
8 QUAL2E-UNCAS: Documentation and User Manual. Athens, GA: U.S. EPA Environmental
9 Research Laboratory. Report EPA/600/3-87/007.
- 10 Buiteveld, H. 1995. A Model for Calculation of Diffuse Light Attenuation (PAR) and Secchi Depth.
11 *Netherlands Journal of Aquatic Ecology*. 29(1): 55-65.
- 12 Bureau of Reclamation. 2009. Great Plains Cooperative Agricultural Weather Network (AgriMet).
13 <http://www.usbr.gov/gp/agrimet/index.cfm>. Accessed 4/10/09.
- 14 Burkholder, J. M. 1996. "Interactions of Benthic Algae With Substrata," in *Algal Ecology-Freshwater*
15 *Benthic Ecosystems*, Stevenson, R. Jan, Bothwell, M. L., and Lowe, R. L., (San Diego, CA:
16 Academic Press): 183-227.
- 17 Carleton, J. N., R. A. Park, and J. S. Clough. 2009. Ecosystem Modeling Applied to Nutrient Criteria
18 Development in Rivers. *Environmental Management*. 2009(44): 485-492.
- 19 Carleton, J. N., M. C. Wellman, P. A. Cocca, A. S. Donigian, R. A. Park, J. T. Love, and J. S. Clough. 2005.
20 Nutrient Criteria Development With a Linked Modeling System: Methodology Development and
21 Demonstration. In: WEF Specialty Conference. WEF TMDL 2005; June 26, 2005; Philadelphia, PA.
- 22 Cattaneou, A., T. Kerimian, M. Roberge, and J. Marty. 1997. Periphyton Distribution and Abundance on
23 Substrata of Different Size Along a Gradient of Stream Trophity. *Hydrobiologia*. 354: 101-110.
- 24 Chapple, S. 1997. The Yellowstone - The Last Best River. National Geographic. Report 191.
- 25 Chapra, S. C. 1997. Surface Water-Quality Modeling, Boston, MA: McGraw-Hill.
- 26 -----. 2003. Engineering Water Quality Models and TMDLs. *Journal of Water Resources Planning and*
27 *Management*. 129(44): 247-256.
- 28 Chapra, S. C. and D. M. Di Toro. 1991a. Delta Method for Estimating Primary Production, Respiration,
29 and Reaeration in Streams. *Journal of Environmental Engineering*. 117(5): 640-655.

- 1 -----. 1991b. Delta Method for Estimating Primary Production, Respiration, and Reaeration in Streams.
2 *Journal of Environmental Engineering*. 117(5): 640-655.
- 3 Chapra, S. C., G. J. Pelletier, and H. Tao. 2008. A Modeling Framework for Simulating River and Stream
4 Water Quality, Version 2.1: Documentaion and Users Manual. Medford, MA: Civil and
5 Environmental Engineering Department, Tufts University.
- 6 Charles, D. and M. Christie. 2011. Potential Influence of Algal Species Composition, and Other Factors,
7 on Primary Productivity in the Yellowstone River, August and September 2007. Philadelphia, PA:
8 Patrick Center for Environmental Research Academy of Natural Sciences. Report #11-01D.
- 9 Chaudhury, R. R., J. A. Sobrinho, R. M. Wright, and M. Sreenivas. 1998. Dissolved Oxygen Modeling of
10 the Blackstone River (Northeastern United States). *Water Research*. 32(8): 2400-2412.
- 11 Chow, V. T. 1959. Open-Channel Hydraulics, New York: McGraw-Hill.
- 12 Crabtree, R. W., I. D. Cluckie, C. F. Forster, and C. P. Crockett. 1986. A Comparison of Two River Quality
13 Models. *Water Research*. 20(1): 53-61.
- 14 Cushing, C. E., G. W. Minshall, and J. D. Newbold. 1993. Transport Dynamics of Fine Particulate Organic
15 Matter in Two Idaho Streams. *Limnology and Oceanography*. 38(6): 1101-1115.
- 16 Cuthbert, I. D. and P. Giorgio. 1992. Toward a Standard Method of Measuring Color in Freshwater.
17 *Limnology and Oceanography*. 37(6): 1319-1326.
- 18 Daley, R. J. and S. R. Brown. 1973. Chlorophyll, Nitrogen, and Photosynthetic Patterns During Growth
19 and Senescence of Two Blue-Green Algae. *Journal of Phycology*. 9(4): 395-401.
- 20 Davies-Colley, R. J. 1992. Yellow Substance in Coastal and Marine Waters Round the South Island, New
21 Zealand. *New Zealand Journal of Marine and Freshwater Research*. 26: 311-322.
- 22 de Azevedo, L. G. T., T. K. Gates, D. G. Fontane, J. W. Labadie, and R. L. Porto. 2000. Integration of Water
23 Quantity and Quality in Strategic River Basin Planning. *Journal of Water Resources Planning and
24 Management*. 126(2): 85-97.
- 25 de Jonge, V. N. 1980. Fluctuations in the Organic Carbon to Chlorophyll a Ratios for Estuarine Benthic
26 Diatom Populations. *Marine Ecology Progress Series*. 2: 345-353.
- 27 deBruyn, A. M. H., D. J. Marcogliese, and J. B. Rasmussen. 2003. The Role of Sewage in a Large River
28 Food Web. *Canadian Journal of Fisheries and Aquatic Sciences*. 60: 1332-1344.
- 29 Deegan, L. A. and B. J. Peterson. 1992. Whole-River Fertilization Stimulates Fish Production in an Arctic
30 Tundra River. *Canadian Journal of Fisheries and Aquatic Sciences*. 49: 1890-1901.

- 1 Di Toro, D. M. 1978. Optics of Turbid Estuarine Waters: Approximations and Applications. *Water Res.* 12:
2 1059-1068.
- 3 ----. 1980. Applicability of Cellular Equilibrium and Monod Theory to Phytoplankton Growth Kinetics.
4 *Ecological Modelling.* 8: 201-218.
- 5 Dilks, D. W., R. P. Canale, and P. G. Meier. 1992. Development of Bayesian Monte Carlo Techniques for
6 Water Quality Model Uncertainty. *Ecological Modelling.* 62(1992): 149-162.
- 7 Dillon, P. J. and W. B. Kirchner. 1975. The Effects of Geology and Land Use on the Export of Phosphorus
8 From Watersheds. *Water Research.* 9(2): 135-148.
- 9 Diskin, M. H. and E. Simon. 1977. A Procedure for the Selection of Objective Functions for Hydrologic
10 Simulation Models. *Journal of Hydrology.* 34(1977): 129-149.
- 11 Dodds, W. K. 1991. Factors Associated With Dominance of the Filamentous Green Algae *Cladophora*
12 *Glomerata.* *Water Research.* 25: 1325-1332.
- 13 ----. 2006. Eutrophication and Trophic State in Rivers and Streams. *Limnology and Oceanography.* 51(1):
14 671-680.
- 15 Dodds, W. K., W. W. Bouska, J. L. Eitzmann, T. J. Pilger, K. L. Pitts, A. J. Riley, J. T. Schloesser, and D. J.
16 Thornbrugh. 2009. Eutrophication of U.S. Freshwaters: Analysis of Potential Economic Damages.
17 *Environmental Science and Technology.* 43(1): 12-19.
- 18 Dodds, W. K. and D. A. Gutter. 1991. Review: The Ecology of *Cladophora.* *Journal of Phycology.* 28: 415-
19 427.
- 20 Dodds, W. K., V. H. Smith, and K. Lohman. 2002. Nitrogen and Phosphorus Relationships to Benthic Algal
21 Biomass in Temperate Streams. *Canadian Journal of Fisheries and Aquatic Sciences.* 59: 865-874.
- 22 ----. 2006. Erratum: Nitrogen and Phosphorus Relationships to Benthic Algal Biomass in Temperate
23 Streams. *Canadian Journal of Fisheries and Aquatic Sciences.* 63: 1190-1191.
- 24 Dodds, W. K., V. H. Smith, and B. Zander. 1997. Developing Nutrient Yargets to Control Benthic
25 Chlorophyll Levels in Streams: A Case Study of the Clark Fork River. *Water Research.* 31(7): 1738-
26 1750.
- 27 Dodds, W. K. and E. B. Welch. 2000. Establishing Nutrient Criteria in Streams. *Journal of the North*
28 *American Benthological Society.* 19: 186-196.
- 29 Drolc, A. and J. Z. Koncan. 1996. Water Quality Modelling of the River Sava, Slovenia. *Water Research.*
30 30(11): 2587-2592.

- 1 ----. 1999. Calibration of QUAL2E Model for the Sava River (Slovenia). *Water Science and Technology*.
2 40(10): 111-118.
- 3 Droop, M. R. 1973. Some Thoughts on Nutrient Limitation in Algae. *Journal of Phycology*. 9: 264-272.
- 4 Dussailant, A., J. F. Munoz, P. Saez, and C. Pantoja. 1997. Water Quality Modelling of Mapocho River,
5 Chile, Using QUAL2E-UNCAS. In: Water Pollution. Fourth International Conference on Water
6 Pollution Modelling, Measuring, and Prediction; Bled, Slovenia. 567-576.
- 7 Edburg, N. and B. V. Hofsten. 1973. Oxygen Uptake of Bottom Sediments Studied in Situ and in the
8 Laboratory. *Wat.Res.* 7(1973): 1285-1294.
- 9 Eppley, R. W. 1972. Temperature and Phytoplankton Growth in the Sea. *Fishery Bulletin*. 70(4): 1063-
10 1085.
- 11 European Inland Fisheries Advisory Council. 1969. Water Quality Criteria for European Freshwater Fish -
12 Extreme PH Values and Inland Fisheries. *Water Research*. 3: 593-611.
- 13 Falkowski, P. G. and J. LaRoche. 1991. Acclimation to Spectral Irradiance in Algae. *Journal of Phycology*.
14 27: 8-14.
- 15 Fang, X., J. Zhang, Y. Chen, and X. Xu. 2008. QUAL2K Model Used in the Water Quality Assessment of
16 Qiantang River, China. *Water Environment Research*. 80(11): 2125-2133.
- 17 Farnsworth, R. K. and E. S. Thompson. 1982. Mean Monthly, Seasonal, and Annual Pan Evaporation for
18 the United States. Washington, D.C.: National Weather Service Office of Hydrology. Report
19 NOAA Technical Report NWS 34.
20 http://www.nws.noaa.gov/oh/hdsc/PMP_related_studies/TR34.pdf.
- 21 Farnsworth, R. K., E. S. Thompson, and E. L. Peck. 1982. Evaporation Atlas for the Contiguous 48 United
22 States. Washington, D.C.: National Weather Service Office of Hydrology. Report NOAA Technical
23 Report NWS 33. http://www.nws.noaa.gov/oh/hdsc/PMP_related_studies/TR33.pdf.
- 24 Flynn, K. and M. Suplee. 2010. Defining Large Rivers in Montana Using a Wadeability Index. Helena, MT.
25 Report Montana DEQ Agency White Paper.
- 26 Frank, D. A. and P. M. Groffman. 2010. Ungulate Vs. Landscape Control of Soil C and N Processes in
27 Grasslands of Yellowstone National Park. *Ecology*. 79(7): 2229-2241.
- 28 Freeman, M. C. 1986. The Role of Nitrogen and Phosphorus in the Development of *Cladophora*
29 *Glomerata* (L.) Kutzing in the Manawatu River, New Zealand. *Hydrobiologia*. 131: 23-30.

- 1 Goldman, J. C., J. J. McCarthy, and D. G. Peavey. 1979. Growth Rate Influence on the Chemical
2 Composition of Phytoplankton in Oceanic Waters. *Nature*. 279(17): 210-215.
- 3 Gücker, B., M. Brauns, and M. T. Pusch. 2006. Effects of Wastewater Treatment Plant Discharge on
4 Ecosystem Structure and Function of Lowland Streams. *Journal of the North American*
5 *Benthological Society*. 25(2): 313-329.
- 6 Hakanson, L., J. M. Malmaeus, U. Bodemer, and V. Gerhard. 2003. Coefficients of Variation for
7 Chlorophyll, Green Algae, Diatoms, Cryptophytes and Blue-Greens in a Rivers As a Basis for
8 Predictive Modelling and Aquatic Management. *Ecological Modelling*. 169(2003): 179-196.
- 9 Hall, J. C., W. T. Hall, D. Di Toro, and T. Gallagher. 2009. Critical Evaluation of EPA's Draft Empirical
10 Approaches for Nutrient Criteria Derivation. In: EPA Science Advisory Board Review; Sept. 9,
11 2009.
- 12 Harmel, R. D., R. J. Cooper, R. M. Slade, R. L. Haney, and J. G. Arnold. 2006. Cumulative Uncertainty in
13 Measured Streamflow and Water Quality Data for Small Watersheds. *Transactions of the ASABE*.
14 49(3): 689-701.
- 15 Harris, G. P. 1986. *Phytoplankton Ecology - Structure, Function, and Fluctuation*, New York, NY:
16 Chapman and Hall Ltd.
- 17 Harvey, C. J., B. J. Peterson, W. B. Bowden, A. E. Hershey, M. C. Miller, L. A. Deegan, and J. C. Finlay.
18 1998. Biological Responses to Fertilization of Oksrukuyik Creek, a Tundra Stream. *Journal of the*
19 *North American Benthological Society*. 17(2): 190-209.
- 20 Heiskary, S., R. W. Bouchard, and H. Markus. 2010. Minnesota Nutrient Criteria Development for Rivers.
21 Saint Paul, MN: Minnesota Pollution Control Agency.
22 <http://www.pca.state.mn.us/index.php/view-document.html?gid=14947>.
- 23 Hessen, D. O., T. Anderson, P. Brettum, and B. A. Faafeng. 2003. Phytoplankton Contribution to Sestonic
24 Mass and Elemental Ratios in Lakes: Implications for Zooplankton Nutrition. *Limnology and*
25 *Oceanography*. 48(3): 1289-1296.
- 26 Hickey, C. W. 1988. Benthic Chambers for Use in Rivers: Testing Against Oxygen Demand Mass Balances.
27 *Journal of Environmental Engineering*. 114(1988): 828-845.
- 28 Hill, W. R. 1996. "Effects of Light," in *Algal Ecology: Freshwater Benthic Ecosystems*, Stevenson, R. J.,
29 Bothwell, M. L., and Lowe, R. L., Ch. 5, (San Diego, CA: Academic Press): 121-148.
- 30 Hill, W. R. and B. C. Harvey. 1990. Periphyton Responses to Higher Trophic Levels and Light in a Shaded
31 Stream. *Canadian Journal of Fisheries and Aquatic Sciences*. 47: 2307-2314.

- 1 Hill, W. R., M. G. Ryon, and E. M. Schilling. 1995. Light Limitation in a Stream Ecosystem: Responses by
2 Primary Producers and Consumers. *Ecology*. 74(4): 1297-1309.
- 3 Hillebrand, H. and U. Sommer. 1999. The Nutrient Stoichiometry of Benthic Microalgal Growth: Redfield
4 Proportions Are Optimal. *Limnology and Oceanography*. 44(2): 440-446.
- 5 Hilsenhoff, W. L. 1987. An Improved Biotic Index of Organic Stream Pollution. *Great Lakes Entomologist*.
6 20(1): 31-39.
- 7 Hjulstrom, F. 1935. Studies of the Morphological Activity of Rivers As Illustrated by the River Fyris.
8 *Bulletin of the Geological Institute, University of Uppsala*. 25(1935): 221-527.
- 9 Holderman, C., G. Hoyle, R. Hardy, P. Anders, P. Ward, and H. Yassien. 2009. Libby Dam Hydro-Electric
10 Project Mitigation: Efforts for Downstream Ecosystem Restoration. In: 33rd IAHR Congress:
11 Water Engineering for a Sustainable Environment. 33rd IAHR Congress: Aug. 9, 2009; Vancouver,
12 BC.
- 13 Holloway, J. M., R. A. Dahlgren, and W. H. Casey. 1998. Contribution of Bedrock Nitrogen to High Nitrate
14 Concentrations in Stream Water. *Nature*. 395: 785-788.
- 15 Homer, C., C. Huang, L. Yang, B. Wylie, and M. Coan. 2004. Development of a 2001 National Landcover
16 Database for the United States. *Photogrammetric Engineering and Remote Sensing*. 70(7): 829-
17 840.
- 18 Hornberger, G. M. and R. C. Spear. 1980. Eutrophication in Peel Inlet, I. The Problem: Defining Behavior
19 and a Mathematical Model for the Phosphorus Scenario. *Water Research*. 14: 29-42.
- 20 Horner, R. R., E. B. Welch, M. R. Seeley, and J. M. Jacoby. 1990. Response of Periphyton to Changes in
21 Current Velocity, Suspended Sediment and Phosphorus Concentrations. *Freshwater Biology*. 24:
22 215-232.
- 23 Horner, R. R., E. B. Welch, and R. B. Veenstra. 1983. "Development of Nuisance Periphytic Algae in
24 Laboratory Streams in Relation to Enrichment and Velocity," in *Periphyton of Freshwater
25 Ecosystems*, Ch. 16, (The Hague: Dr. W. Junk Publishers): 121-134.
- 26 Hoyle, G. M. 2003. Responses of Periphyton, Benthic Macroinvertebrates, and Juvenile White Sturgeon
27 to Experiment Additions of Nitrogen and Phosphorus in the Kootenai River, Idaho.: University of
28 Idaho.
- 29 Hummel, P. R., J. L. Kittle, and M. H. Gray. 2001. WDMUtil - A Tool for Managing Watershed Modeling
30 Time-Series Data, Version 2.27: U.S. Environmental Protection Agency.
- 31 Hydmet, Inc. 2009. Yellowstone River Climatological Database.

- 1 Hynes, H. B. N. 1966. *The Biology of Polluted Waters*, 3rd ed., Liverpool: Liverpool University Press.
- 2 ----- 1969. "The Enrichment of Streams," in *Eutrophication: Causes, Consequences, Correctives*, Rohlich,
3 G. A., Ch. III, (Washington, D.C.: National Academy of Sciences): 188-196.
- 4 Ittekkot, V. and R. W. P. M. Laane. 1991. "Fate of Riverine Particulate Organic Matter," in
5 *Biogeochemistry of Major World Rivers* Scientific Committee On Problems of the Environment
6 (SCOPE) and United Nations Environment Programme (UNEP), Ch. 10, (Chichester, N.Y.: Wiley)
- 7 Jehng-Jung, K. and S. Bau. 1995. Risk Analysis for Flow Duration Curve Based Seasonal Discharge
8 Management Programs. *Water Research*. 30(6): 1369-1376.
- 9 Kahlert, M. 1998. C:N:P Ratios of Freshwater Benthic Algae. *Archiv Für Hydrobiologie - Advances in*
10 *Limnology*. 51(1998): 105-114.
- 11 Kannel, P. R., S. Lee, S. R. L. Y. S. Kanel, and K. H. Ahn. 2006. Application of QUAL2Kw for Water Quality
12 Modeling and Dissolved Oxygen Control in the River Bagmati. *Environmental Monitoring and*
13 *Assessment*. 125: 201-217.
- 14 Karp, Richard W., Duane A. Klarich, Maxwell K. Botz, and William H. Garvin. 1977. Waste Load Allocation
15 Investigation of the Yellowstone River in the Vicinity of Billings, Montana. Helena, MT: Water
16 Quality Bureau, Environmental Sciences Division, Montana Department of Health and
17 Environmental Sciences.
- 18 Kirk, J. T. O. 1994. *Light and Photosynthesis in Aquatic Ecosystems*, Cambridge, U.K.: Cambridge
19 University Press.
- 20 Klarich, Duane A. 1976. Estimates of Primary Production and Periphyton Community Structure in the
21 Yellowstone River (Laurel to Huntley, Montana). Billings, MT: Montana Department of Health
22 and Environmental Sciences.
- 23 ----- 1977. Changes in Periphyton Productivity in the Yellowstone River Between Laurel and Huntley,
24 Montana. *Proceedings of the Montana Academy of Sciences*. Vol. 37: 2-27.
- 25 Klarich, Duane A. and Jim Thomas. 1977. The Effect of Altered Streamflow on the Water Quality of the
26 Yellowstone River Basin, Montana. Helena, MT: Montana Department of Natural Resource and
27 Conservation. Report Yellowstone Impact Study Technical Report No. 3.
- 28 Klausmeier, C. A., E. Litchman, T. Daufresne, and S. A. Levin. 2004. Optimal Nitrogen-to-Phosphorus
29 Stiochiometry of Phytoplankton. *Nature*. 429(2004): 171-174.
- 30 Knudson, Ken and Dick Swanson. 1976. Effects of Decreased Water Quantity and Increased Nutrient
31 Additions on Algal Biomass Accumulation, and Subsequently, the Dissolved Oxygen Balance of
32 the Yellowstone River. Helena, MT: Montana Department of Fish and Game.

- 1 Koch, Roy, Robert Curry, and Mark Weber. 1977. The Effect of Altered Streamflow on the Hydrology and
2 Geomorphology of the Yellowstone River Basin, Montana. Helena, MT: Montana Department of
3 Natural Resources and Conservation. Report Yellowstone Impact Study Technical Report No. 2.
- 4 Kuhn, G. 1991. Calibration, Verification, and Use of a Steady-State Stream Water-Quality Model for
5 Monument and Fountain Creeks, East-Central Colorado. Denver, Colorado. Water Resources
6 Investigations. Report 91-4055.
- 7 Law, J. P. and G. V. Skogerboe. 1972. Potential for Controlling Quality of Irrigation Return Flows. *Journal*
8 *of Environmental Quality*. 1: 140-145.
- 9 Laws, E. A. 2000. Aquatic Pollution, third ed., New York: John Wiley & Sons, Inc.
- 10 Lenat, D. R. and D. L. Penrose. 1996. History of the EPT Taxa Richness Metric. *Bulletin of the North*
11 *American Benthological Society*. 13(2): 305-307.
- 12 Leopold, L. B. and T. Maddock. 1953. The Hydraulic Geometry of Stream Channels and Some
13 Physiographic Implications. Report USGS Professional Paper 252.
14 [http://eps.berkeley.edu/people/lunaleopold/\(040\)%20The%20Hydraulic%20Geometry%20of%20](http://eps.berkeley.edu/people/lunaleopold/(040)%20The%20Hydraulic%20Geometry%20of%20Stream%20Channels%20and%20Some%20Physiographic%20Implications.pdf)
15 [Stream%20Channels%20and%20Some%20Physiographic%20Implications.pdf](http://eps.berkeley.edu/people/lunaleopold/(040)%20The%20Hydraulic%20Geometry%20of%20Stream%20Channels%20and%20Some%20Physiographic%20Implications.pdf).
- 16 Lesica, P. and S. Miles. 2001. Tamarisk Growth at the Northern Margins of Its Naturalized Range in
17 Montana, USA. *Wetlands*. 21(2): 240-246.
- 18 Li, B. and M. T. Brett. 2011. The Impact of Alum Based Advanced Nutrient Removal Processes on
19 Phosphorus Bioavailability. Unpublished work.
- 20 Linacre, E. 1992. Climate Data and Resources: a Reference and Guide, New York, NY: Routledge,
21 Chapman, and Hall, Inc.
- 22 Ling, T., C. Ng, N. Lee, and D. Buda. 2009. Oxygen Sediment Demand From the Semariang Batu River
23 Malaysia. *World Applied Sciences Journal*. 7: 440-447.
- 24 Linsley, R. K., M. A. Kohler, and J. L. H. Paulhus. 1982. Hydrology for Engineers, New York: McGraw-
25 Hill, Inc.
- 26 Little, K. W. and R. E. Williams. 1992. Least-Squares Calibration of QUAL2E. *Water Environment*
27 *Research*. 64(2): 179-185.
- 28 Lohman, K. and John C. Priscu. 1992. Physiological Indicators of Nutrient Deficiency in *Cladophora*
29 (Chlorophyta) in the Clark Fork of the Columbia River, Montana. *Journal of Phycology*. 28: 443-
30 448.

- 1 Lorenzen, C. J. 1972. Extinction of Light in the Ocean by Phytoplankton. *ICES Journal of Marine Science*.
2 34(2): 262-267.
- 3 User's Manual for SWSTAT, a Computer Program for Interactive Computation of Surface-Water
4 Statistics. Ver. Draft. U.S. Geological Survey. 1993.
- 5 Manache, G., W. Bauwens, and C. S. Melching. 2000. Reliability Analysis of a Water-Quality Model
6 Considering Uncertainty in the Model Parameters. In: *Monitoring and Modelling Catchment*
7 *Water Quantity and Quality*; Sept. 27, 2000; Ghent, Belgium. 53-60.
- 8 McBride, G. B. and S. C. Chapra. 2005. Rapid Calculation of Oxygen in Streams: Approximate Delta
9 Method. *Journal of Environmental Engineering*. 131(3): 336-342.
- 10 McCarthy, P. M. 2004. Statistical Summaries of Streamflow in Montana and Adjacent Areas, Water Years
11 1900 Through 2002. Reston, VA: U.S. Geological Survey. Report Scientific Investigations Report
12 2004-5266.
- 13 ----. 2006. A Computer Program for Estimating Instream Travel Times and Concentrations of a Potential
14 Contaminant in the Yellowstone River, Montana. U.S. Geological Survey. Report Scientific
15 Investigations Report 2006-5057.
- 16 ----. 2009. Travel Times, Streamflow Velocities, and Dispersion Rates in the Yellowstone River, Montana.
17 U.S. Geological Survey. Report Scientific Investigations Report 2009-5261.
- 18 McKay, M. D., R. J. Beckman, and W. J. Conover. 1979. A Comparison of Three Methods for Selecting
19 Values of Input Variables in the Analysis of Output From a Computer Code. *Technometrics*.
20 21(2): 239-245.
- 21 McPherson, B. F. and R. L. Miller. 1994. Causes of Light Attenuation in Tampa Bay and Charlotte Harbor,
22 Southwestern Florida. *Water Resources Bulletin*. 30(1): 43-53.
- 23 Melching, C. S. and C. G. Yoon. 1996. Key Sources of Uncertainty in QUAL2E Model of Passaic River.
24 *Journal of Water Resources Planning and Management*. 122(2): 105-113.
- 25 Meybeck, M. 1982. Carbon, Nitrogen, and Phosphorus Transport by World Rivers. *American Journal of*
26 *Science*. 282(1982): 401-450.
- 27 Miller, K. A., M. L. Clark, and P. R. Wright. 2004. Water Quality Assessment of the Yellowstone River
28 Basin, Montana and Wyoming: Water Quality of Fixed Sites 1999-2001. Reston, VA: U.S.
29 Geological Survey. Report Scientific Investigations Report 2004-5113.
- 30 Miller, W. M., J. C. Guitiães, C. N. Mahannah, and H. M. Joung. 1978. Pollutant Contributions From
31 Irrigation Surface Return Flows. *Journal of Environmental Quality*. 7: 35-40.

- 1 Mills, W. B., G. L. Bowie, T. M. Grieb, K. M. Johnson, and R. C. Whittemore. 1986. Stream Sampling for
2 Waste Load Allocation Application. Washington, D.C.: U.S. EPA Office of Research and
3 Development. Report EPA/625/6-86/013.
- 4 Montana Board of Health. 1952. A Report of Water Pollution in the Yellowstone Drainage Basin [A
5 Cooperative State-Federal Report on Water Pollution]. Washington, DC: Federal Security
6 Agency, Public Health Service. Report Pollution Series no. 23, Public Health Service Publication
7 No. 129.
- 8 -----. 1956. Pollution of Yellowstone River As Related to Taste and Odor Problems in Municipal Water
9 Supplies in Montana and North Dakota. Helena, MT: State Board of Health.
- 10 -----. 1963. Water Pollution in the Yellowstone River Drainage in Montana. Helena, MT: Montana State
11 Board of Health. Report Progress Report No. 63-1.
- 12 -----. 1967. 1967 Yellowstone River Survey in Billings, Montana. Division of Environmental Sanitation.
- 13 Montana Bureau of Mines and Geology. 2008. Groundwater Information Center (GWIC).
14 <http://mbmaggwic.mtech.edu/>. Accessed 11/7/08.
- 15 Montana Department of Environmental Quality. 2009. Yellowstone River Assessment Record Segment
16 MT42K001_010 and MT42M001_012. Clean Water Act Information Center.
17 <http://www.cwaic.mt.gov/>. Accessed 6/17/09.
- 18 -----. 2010. Box Elder Creek Nutrient Addition Study: a Project to Provide Key Information on the
19 Development of Nutrient Criteria in Montana Prairie Streams. Helena, MT. Report Quality
20 Assurance Project Plan.
- 21 -----. 2011a. Periphyton Standard Operating Procedure. Water Quality Planning Bureau. Report
22 WQPBWQM-010.
- 23 -----. 2011b. Sample Collection and Laboratory Analysis of Chlorophyll-a, Standard Operating Procedure.
24 Helena, MT: Water Quality Planning Bureau. Report WQPBWQM-011.
- 25 Montana Department of Natural Resources and Conservation. 1976. River Mile Index of the Yellowstone
26 River. Water Resources Division - Department of Natural Resources and Conservation (DNRC).
- 27 Montana Natural Resource Information System. 2009. Yellowstone River Corridor Resource
28 Clearinghouse. <http://nris.mt.gov/yellowstone/>. Accessed 9/15/09.
- 29 Moulder, E. A. and F. A. Kohout. 1958. Ground-Water Factors Affecting Drainage in the First Division,
30 Buffalo Rapids Irrigation Project Prairie and Dawson Counties, Montana. Washington, D.C.:
31 United State Government Printing Office. Report Geological Survey Water-Supply Paper 1424.

- 1 Moulder, E. A., A. E. Torrey, and F. C. Koopman. 1953. Ground-Water Factors Affecting the Drainage of
2 Area IV First Division, Buffalo Rapids Irrigation Project Montana. Washington, D.C.: United States
3 Government Printing Office. Report Geological Survey Circular 198.
- 4 Muller, P., X. Li, and K. Niyogi. 2001. Non-Photochemical Quenching. A Response to Excess Light Energy.
5 *Plant Physiology*. 125(2001): 1558-1566.
- 6 Murdock, J. and W. K. Dodds. 2007. Linking Benthic Algal Biomass to Stream Substratum Topography.
7 *Journal of Phycology*. 43(2007): 449-460.
- 8 National Oceanic and Atmospheric Administration. 2009. National Climatic Data Center (NCDC).
9 <http://www.ncdc.noaa.gov/oa/ncdc.html>. Accessed 5/21/09.
- 10 -----. 2010a. GLOBALVIEW-CO2 Earth System Research Laboratory.
11 http://www.esrl.noaa.gov/gmd/ccgg/globalview/co2/co2_intro.html. Accessed 5/18/10a.
- 12 -----. 2010b. GLOBALVIEW-CO2: Cooperative Atmospheric Data Integration Project - Carbon Dioxide.
13 Boulder, Colorado: Environmental Systems Research Laboratory.
14 http://www.esrl.noaa.gov/gmd/ccgg/globalview/co2/co2_intro.html. Accessed 5/18/10b.
- 15 -----. 2010c. Sunrise/Sunset Calculator. Environmental Systems Research Laboratory.
16 <http://www.srrb.noaa.gov/highlights/sunrise/sunrise.html>. Accessed 10/19/10c.
- 17 National Renewable Energy Laboratory. 2007. National Solar Radiation Database 1991-2005 Update:
18 User's Manual. Report NREL/TP-581-41364.
- 19 Natural Resource Conservation Service. 2003. Yellowstone River Floodplain Vegetation.
20 <http://nris.mt.gov/yellowstone/loweryel/geomorph/vegcover.zip>. Accessed 9/23/09.
- 21 Neff, J. C., A. P. Ballantyne, G. L. Farmer, N. M. Mahowald, J. L. Conroy, C. C. Landry, J. T. Overpeck, T. H.
22 Painter, C. R. Lawrence, and R. L. Reynolds. 2008. Increasing Eolian Dust Deposition in the
23 Western United States Linked to Human Activity. *Nature Geoscience*. 1(2008): 189-195.
- 24 Ning, S. K., N. Chang, L. Yong, H. W. Chen, and H. Y. Hsu. 2000. Assessing Pollution Prevention Program
25 by QUAL2E Simulation Analysis for the Kao-Ping River Basin, Taiwan. *Journal of Environmental*
26 *Management*. 60(2000): 1-17.
- 27 Novotny, V. and H. Olem. 1994. Water Quality Prevention, Identification, and Management of Diffuse
28 Pollution, New York: Van Nostrand Reinhold Press.
- 29 Odum, H. T. 1956. Primary Production in Flowing Waters. *Limnology and Oceanography*. 1: 102-117.

- 1 Omernik, James M. 1977. Nonpoint Source – Stream Nutrient Level Relationships: A Nationwide Study.
2 Corvallis, OR: United States Environmental Protection Agency, Office of Research and
3 Development, Environmental Research Laboratory. Report EPA-600/3-77-105.
- 4 Ongley, E. D. 1996. Control of Water Pollution From Agriculture - FAO Irrigation and Drainage Paper 55.
5 Burlington, Canada: GEMS/Water Collaborating Centre Canada Centre for Inland Waters.
- 6 Palmstrom, N. S., R. E. Carlson, and D. Cooke. 1988. Potential Links Between Eutrophication and the
7 Formation of Carcinogens in Drinking Water. *Lake and Reservoir Management*. 4(2): 1-15.
- 8 Park, S. S. and Y. S. Lee. 2002. A Water Quality Modeling Study of the Nakdong River, Korea. *Ecological*
9 *Modelling*. 152(1): 65-75.
- 10 Paschal, J. E. and D. K. Mueller. 1991. Simulation of Water Quality and the Effects of Waste-Water
11 Effluent on the South Platte River From Chatfield Reservoir Through Denver, Colorado. Denver,
12 Colorado. Water Resources Investigation Report. Report WRI-91-4016.
- 13 Peel, M. C., B. L. Finlayson, and T. A. McMahon. 2007. Updated World Map of the Koppen-Geiger
14 Climate Classification. *Hydrol.Earth Syst.Sci*. 11(5): 1633-1644.
- 15 Shade.Xls: a Tool for Estimating Shade From Riparian Vegetation. Ver. 2. Washington State Department
16 of Ecology. 2007.
- 17 Perrin, C. J., M. L. Bothwell, and P. A. Slaney. 1987. Experimental Enrichment of a Coastal Stream in
18 British Columbia: Effects of Organic and Inorganic Additions on Autotrophic Periphyton
19 Production. *Canadian Journal of Fisheries and Aquatic Sciences*. 44: 1247-1256.
- 20 Peterson, C. G. 1996. "Response of Algae to Natural Physical Disturbance," in *Algal Ecology-Freshwater*
21 *Benthic Ecosystems*, Stevenson, R. Jan, Bothwell, M. L., and Lowe, R. L., (San Diego, CA:
22 Academic Press): 183-227.
- 23 Peterson, D. A. 2009. Algal and Water-Quality Data for the Yellowstone River and Tributaries, Montana
24 and Wyoming, 1999-2000. Report U.S. Geological Survey Data Series 484.
- 25 Peterson, David A. and Stephen D. Porter. 2002. Biological and Chemical Indicators of Eutrophication in
26 the Yellowstone River and Major Tributaries During August 2000. Washington, DC: National
27 Water Quality Monitoring Council.
- 28 Peterson, David A., Stephen D. Porter, and Stacy M. Kinsey. 2001. Chemical and Biological Indicators of
29 Nutrient Enrichment in the Yellowstone River Basin, Montana and Wyoming, August 2000: Study
30 Design and Preliminary Results. Cheyenne, WY: U.S. Geological Survey. Report Water-Resources
31 Investigations Report 01-4238.

- 1 Philadelphia Academy of Natural Sciences. 2008. Yellowstone River Algal Assemblage Ecological
2 Interpretations. Prepared for the Montana Department of Environmental Quality, Water Quality
3 Planning Bureau. September 30, 2008.
- 4 Philips, E. J., M. Cichra, F. J. Aldridge, J. Jembekc, J. Hendrickson, and R. Brody. 2000. Light Availability
5 and Variations in Phytoplaknton Standing Crops in a Nutrient-Rich Blackwater River. *Limnology*
6 *and Oceanography*. 45(4): 916-929.
- 7 Pochop, L. O., K. Warnaka, J. Borrelli, and V. Hasfurther. 1985. Design Information for Evaporation Ponds
8 in Wyoming. Department of Agricultural Engineering, University of Wyoming: Wyoming Water
9 Research Center. Report WWRC-85-21. <http://library.wrds.uwyo.edu/wrp/85-21/85-21.html>.
10 Accessed 5/2/11.
- 11 Porter, K. S. 1975. Nitrogen and Phosphorus. Food Production, Waste, and the Environment. K. S Porter
12 (Ed.), Ann Arbor: Ann Arbor Science.
- 13 Porter, S. D., T. F. Cuffney, M. E. Gurtz, and M. R. Meador. 1993. Methods for Collecting Algal Samples As
14 Part of the National Water-Quality Assessment Program. Raleigh, North Carolina: U.S. Geological
15 Survey. Report Open-File Report 93-409. [http://water.usgs.gov/nawqa/protocols/OFR-93-
16 409/alg1.html](http://water.usgs.gov/nawqa/protocols/OFR-93-409/alg1.html).
- 17 Pretty, J. N., C. F. Mason, D. B. Nedwell, R. E. Hine, S. Leaf, and R. Dils. 2003. Environmental Costs of
18 Freshwater Eutrophication in England and Wales. *Environmental Science & Technology*. 37(2):
19 201-208.
- 20 PRISM Climate Group Oregon Climate Service. 2006. United States Average Daily Maximum
21 Temperature, 1971-2000. http://nris.mt.gov/nsdi/nris/tmax71_00.html. Accessed 3/23/11.
- 22 Quinn, J. M., A. B. Cooper, M. J. Stroud, and G. P. Burrell. 1997. Shade Effects on Stream Periphyton and
23 Invertebrates: An Experiment in Streamside Channels. *New Zealand Journal of Marine and
24 Freshwater Research*. 31: 665-683.
- 25 Rantz, S. E. 1982. Measurement and Computation of Streamflow: Volume 1. Measurement of Stage and
26 Discharge. Washington, DC: United State Government Printing Office. Report USGS Water
27 Supply Paper 2174.
- 28 Rauch, W., M. Henze, L. Koncsos, P. Reichert, P. Shanahan, L. Somlyody, and P. Vanrollegem. 1998.
29 River Water Quality Modelling: I. State of the Art. In: IAWQ Biennial International Conference;
30 June 21, 1998; Vancouver, British Columbia, Canada.
- 31 Reckhow, K. H. 1994. Water Quality Simulation Modeling and Uncertainty Analysis for Risk Assessment.
32 *Ecological Modelling*. 72(1994): 1-20.

- 1 -----. 2003. On the Need for Uncertainty Assessment in TMDL Modeling and Implementation. *Journal of*
2 *Water Resources Planning and Management*. 129(4): 247-256.
- 3 Reckhow, K. H., G. B. Arhonditsis, M. A. Kenney, L. Hauser, J. Tribo, C. Wu, K. J. Elcock, L. J. Steinberg, C.
4 A. Stow, and S. J. McBride. 2005. A Predictive Approach to Nutrient Criteria. *Environmental*
5 *Science and Technology*. 39(9): 2913-2919.
- 6 Reckhow, K. H. and S. C. Chapra. 1983. Confirmation of Water Quality Models. *Ecological Modelling*.
7 20(1983): 113-133.
- 8 -----. 1999. Modeling Excessive Nutrient Loadings in the Environment. *Environmental Pollution*.
9 100(1999): 197-207.
- 10 Redfield, A. C. 1958. The Biological Control of Chemical Factors in the Environment. *American Scientist*.
11 46: 205-221.
- 12 Reynolds, C. S. 1993. *The Ecology of Freshwater Phytoplankton*, Cambridge, Great Britain: University
13 Press.
- 14 Rhee, G. Y. 1973. A Continuous Culture Study of Phosphate Uptake, Growth Rate and Polyphosphate in
15 *Scenedesmus Sp.* *Journal of Phycology*. 9: 495-506.
- 16 -----. 1978. Effects of N:P Atomic Ratios and Nitrate Limiation on Algal Growth, Cell Composition, and
17 Nitrate Uptake. *Limnology and Oceanography*. 23(1): 10-25.
- 18 Rier, S. T., R.J.Stevenson, and G.D.LaLiberte. 2006. Photo-Aclimation Response of Benthic Stream Algae
19 Across Experimentally Manipulated Light Gradients: A Comparison of Growth Rates and Net
20 Primary Productivity. *Journal of Phycology*. 42(2006): 560-567.
- 21 Robertson-Bryan, Inc. 2004. PH Requirements of Freshwater Aquatic Life. Report Technical
22 memorandum.
- 23 Robinson, P. K. and H. A. Hawkes. 1986. Studies of the Growth of *Cladophora Glomerata* in Laboratory
24 Continuous-Flow Culture. *European Journal of Phycology*. 21: 437-444.
- 25 Rosemond, A. D. 1993. Interactions Among Irradiance, Nutrients, and Herbivores Constrain a Stream
26 Algal Community. *Oecologia*. 94: 585-594.
- 27 Royer, T. V., M. B. David, L. E. Gentry, C. A. Mitchell, K. M. Starks, T. N. Heatherly, and M. R. Whiles.
28 2008. Assessment of Chlorophyll-*a* As a Criterion for Establishing Nutrient Standards in the
29 Streams and Rivers of Illinois. *Journal of Environmental Quality*. 37: 437-447.

- 1 Rutherford, J. C., M. R. Scarsbrook, and N. Broekhuizen. 2000. Grazer Control of Stream Algae: Modeling
2 Temperature and Flood Effects. *Journal of Environmental Engineering*. 126(4): 331-339.
- 3 Sadak, M. L. 2005. Lower Yellowstone River Bathymetric Data Development to Support Geomorphic &
4 Aquatic Habitat Analysis. Helena, MT: MT Department of Natural Resources and Conservation.
- 5 Sadiq, R. and M. J. Rodriguez. 2004. Disinfection by-Products (DBPs) in Drinking Water and the
6 Predictivemodels for Their Occurrence: a Review. *Science of the Total Environment*. 321(1-3): 21-
7 46.
- 8 Schwarz, D. 1999. Improving Irrigation Efficiency and Water Quality: A Priority Area Proposal. Report
9 Buffalo Rapids 2000 Priority Area EQIP Proposal.
- 10 ----- . 2002. Buffalo Rapids Project. Report Montana NPS 319 Program Final Report Summary.
- 11 Sheeder, S. A. and B. M. Evans. 2004. Estimating Nutrient and Sediment Threshold Criteria for Biological
12 Impairment in Pennsylvania Watersheds. *Journal of the American Water Resources Association*.
13 40(4): 881-888.
- 14 Shuter, B. J. 1978. Size Dependence of Phosphorus and Nitrogen Subsistence Quotas in Unicellular
15 Microorganisms. *Limnology and Oceanography*. 26(6): 1248-1255.
- 16 Smith, A. J. and C. P. Tran. 2010. A Weight-of-Evidence Approach to Define Nutrient Criteria Protective
17 of Aquatic Life in Large Rivers. *Journal of the North American Benthological Society*. 29(3): 875-
18 891.
- 19 Smith, E. L. 1936. Photosynthesis in Relation to Light and Carbon Dioxide. *Proceedings of the National
20 Academy of Sciences*. 22(1936): 504-511.
- 21 Smith, L. N., J. I. LaFave, T. W. Patton, J. C. Rose, and D. P. McKenna. 2000. Ground-Water Resources of
22 the Lower Yellowstone River Area: Dawson, Fallon, Prairie, Richland, and Wibaux Counties,
23 Montana. Report Montana Ground-water Assessment Atlas No. 1.
24 <http://www.mbmgt.mtech.edu/pdf/groundwateratlas1.pdf>. Accessed 6/10/09.
- 25 Smith, V. H., G. D. Tilman, and J. C. Nekola. 1999. Eutrophication: Impacts of Excess Nutrient Inputs on
26 Freshwater, Marine, and Terrestrial Ecosystems. *Environmental Pollution*. 100(1999): 176-196.
- 27 Snelder, T. H., B. J. F. Biggs, and M. A. Weatherhead. 2004. Nutrient Concentration Criteria and
28 Characterization of Patterns in Trophic State for Rivers in Heterogeneous Landscapes. *Journal of
29 the American Water Resources Association*. 40(1): 1-13.
- 30 State Engineer's Office. 1948. Water Resources Survey Part I: History of Land and Water Use on Irrigated
31 Areas; Custer County, Montana.

- 1 http://www.dnrc.mt.gov/wrd/water_rts/survey_books/custerwrs_1948_part1.pdf. Accessed
2 5/15/09.
- 3 Steele, J. H. 1962. Environmental Control of Photosynthesis in the Sea. *Limnology and Oceanography*.
4 7(1962): 137-150.
- 5 Stevenson, R. J. 1990. Benthic Algal Community Dynamics in a Stream During and After a Spate. *Journal*
6 *of the North American Benthological Society*. 9(3): 277-288.
- 7 ----- 1996. "The Stimulation and Drag of Current," in *Algal Ecology-Freshwater Benthic Ecosystems*,
8 Stevenson, R. Jan, Bothwell, M. L., and Lowe, R. L., (San Diego, CA: Academic Press): 183-227.
- 9 Stevenson, R. J., M. L. Bothwell, and R. Lowe. 1996. *Algal Ecology - Freshwater Benthic Ecosystems*, San
10 Diego, CA: Academic Press.
- 11 Stow, C. A., K. H. Reckhow, S. S. Qian, E. C. Lamon, G. B. Arhonditsis, M. E. Borsuk, and D. Seo. 2007.
12 Approaches to Evaluate Water Quality Model Parameter Uncertainty for Adaptive TMDL
13 Implementation. *Journal of the American Water Resources Association*. 43(6): 1499-1507.
- 14 Streeter, H. W. and E. B. Phelps. 1925. A Study of the Pollution and Natural Purification of the Ohio
15 River. III. Factors Concerned in the Phenomena of Oxidation and Reaeration. U.S. Health
16 Service. Report Bulletin No. 146.
- 17 Suplee, M. W., K. F. Flynn, and M. W. Van Liew. 2006a. Quality Assurance Project Plan (QAPP) - Using a
18 Computer-Water Quality Model to Derive Numeric Nutrient Criteria for a Segment of the
19 Yellowstone River.
- 20 ----- 2006b. Sampling and Analysis Plan (SAP) - Using a Computer-Water Quality Model to Derive
21 Numeric Nutrient Criteria for a Segment of the Yellowstone River.
- 22 Suplee, M. W. and R. Sada de Suplee. 2011. Assessment Methodology for Determining Wadeable Stream
23 Impairment Due to Excess Nitrogen and Phosphorus Levels. Helena, MT: Montana Department
24 of Environmental Quality Water Quality Planning Bureau. Report WQPMASTR-01.
- 25 Suplee, M. W., A. Varghese, and J. Cleland. 2007. Developing Nutrient Criteria for Streams: An Evaluation
26 of the Frequency Distribution Method. *Journal of the American Water Resources Association*.
27 43(2): 456-472.
- 28 Suplee, M. W., V. Watson, M. E. Teply, and H. McKee. 2009. How Green Is Too Green? Public Opinion of
29 What Constitutes Undesirable Algae Levels in Streams. *Journal of the American Water Resources*
30 *Association*. 45(1): 123-140.

- 1 Suplee, M. W., V. Watson, A. Varghese, and J. Cleland. 2008. Scientific and Technical Basis of the
2 Numeric Nutrient Criteria for Montana's Wadeable Streams and Rivers.
3 http://www.deq.state.mt.us/wqinfo/Standards/WhitePaper_FNL3_Nov12-08.pdf.
- 4 Suzuki, L. and C. H. Johnson. 2001. Algae Know the Time of Day: Circadian and Photoperiodic Programs.
5 *Journal of Phycology*. 37(2001): 933-942.
- 6 Tao, H. 2008. Calibration, Sensitivity, and Uncertainty Analysis in Surface Water Quality Modeling. PhD.
7 Medford, MA: Tufts University.
- 8 Thomann, R. V. 1982. Verification of Water Quality Models. *Journal of Environmental Engineering*.
9 108(5): 923-940.
- 10 ----- . 1998. The Future Golden Age of Predictive Models for Surface Water Quality and Ecosystem
11 Management. *Journal of Environmental Engineering*. 124(2): 94-103.
- 12 Thomann, R. V. and J. A. Mueller. 1987. Principles of Surface Water Quality Modeling and Control, New
13 York, NY: Harper & Row Publishers.
- 14 Thomas, J. L. and R. L. Anderson. 1976. Water-Energy Conflicts in Montana's Yellowstone River Basin.
15 *American Water Resources Association*. 12(4): 829-842.
- 16 Tischler, L. F., R. M. Bradley, S. J. Park, and D. G. Rhee. 1985. Water Quality Modeling of the Lower Han
17 River, Korea. *Water Science Technology*. 17: 979-990.
- 18 Tomlinson, L. M., M. T. Auer, H. A. Bootsma, and E. M. Owens. 2010. The Great Lakes Cladophora Model:
19 Development, Testing, and Application to Lake Michigan. *Journal of Great Lakes Research*. 36:
20 287-297.
- 21 Torrey, A. E. and F. A. Kohout. 1956. Geology and Ground-Water Resources of the Lower Yellowstone
22 River Valley, Between Glendive and Sidney, Montana. Washington, D.C.: United States
23 Government Printing Office. Report Geological Survey Water-Supply Paper 1355.
- 24 Torrey, A. E. and F. A. Swenson. 1951. Ground-Water Resources of the Lower Yellowstone River Valley
25 Between Miles City and Glendive Montana. Washington, D.C.: United States Government
26 Printing Office.
- 27 Triska, F. J., J. R. Sedell, K. Cromack, and S. V. Gregory. 1984. Nitrogen Budget for a Small Coniferous
28 Forest Stream. *Ecological Monographs*. 54(1): 119-140.
- 29 Troxler, R. W. and E. L. Thackston. 1975. Effect of Meteorological Variables on Temperature Changes in
30 Flowing Streams. Report Ecological Research Series EPA-660/3-75-002.

- 1 Turner, D. F., G. J. Pelletier, and B. Kasper. 2009. Dissolved Oxygen and PH Modeling of a Periphyton
2 Dominated, Nutrient Enriched River. *Journal of Environmental Engineering*. 135(8): 645-652.
- 3 U.S. Environmental Protection Agency. 1972. Water Quality Criteria 1972: A Report of the Committee on
4 Water Quality Criteria. U.S.Environmental Protection Agency (Ed.), EPA-R3-73-033 ed.,
5 Washington D.C.: U.S. Government Printing Office.
- 6 -----. 1976. Quality Criteria for Water. U.S.Environmental Protection Agency (Ed.), Washington , D.C.: U.S.
7 Government Printing Office.
- 8 -----. 1985. Technical Support Document for Water Quality-Based Toxics Control. Washington, D.C.:
9 Office of Water. Report EPA-440/4-85-032.
- 10 -----. 1986a. Quality Criteria for Water 1986. U.S.Environmental Protection Agency (Ed.), EPA 440/5-86-
11 001 ed., Washington, D.C.: U.S. Government Printing Office.
- 12 -----. 1986b. "Stream Design Flow for Steady-State Modeling (Chapter 1)," in *Book VI, Design Conditions –*
13 *Technical Guidance Manual for Performing Wasteload Allocations*, EPA440/4/86-014 ed., Ch. 1
- 14 -----. 1991. Technical Support Document for Water Quality-Based Toxics Control. Washington, D.C.:
15 Office of Water. Report EPA/505/2-90-001.
- 16 -----. 1998. National Strategy for the Development of Regional Nutrient Criteria. Report EPA 822-R-98-
17 002. <http://www.epa.gov/waterscience/criteria/nutrient/strategy/nutstra3.pdf>. Accessed
18 6/8/09.
- 19 -----. 2000a. Ambient Water Quality Criteria Recommendations: Information Supporting the
20 Development of State and Tribal Nutrient Criteria: Rivers and Streams in Nutrient Ecoregion II.
21 Washington, D.C.: U.S. Environmental Protection Agency.
- 22 -----. 2000b. Nutrient Criteria Technical Guidance Manual: Rivers and Streams. Report EPA-822-B-00-002.
23 <http://www.epa.gov/waterscience/criteria/nutrient/guidance/rivers/rivers-streams-full.pdf>.
24 Accessed 6/8/09b.
- 25 -----. 2001. Ambient Water Quality Criteria Recommendations, Information Supporting the Development
26 of State and Tribal Nutrient Criteria Rivers and Streams in Nutrient Ecoregion IV. Office of
27 Water. Report EPA 822-B-01-013.
- 28 -----. 2008a. State Adoption of Numeric Nutrient Standards (1998-2008). Office of Water. Report EPA-
29 821-F-08-007.
30 [http://water.epa.gov/scitech/swguidance/waterquality/standards/upload/2009_01_21_criteria](http://water.epa.gov/scitech/swguidance/waterquality/standards/upload/2009_01_21_criteria_nutrient_report1998-2008.pdf)
31 [_nutrient_report1998-2008.pdf](http://water.epa.gov/scitech/swguidance/waterquality/standards/upload/2009_01_21_criteria_nutrient_report1998-2008.pdf). Accessed 10/11/10a.

- 1 -----. 2008b. STOrage and RETrieval (STORET) Database Availble on the World Wide Web.
2 <http://www.epa.gov/storet/>. Accessed 10/3/08b.
- 3 -----. 2010a. Clean Air Status and Trends Network (CASTNET). <http://www.epa.gov/castnet/index.html>.
4 Accessed 2/4/10a.
- 5 -----. 2010b. Clean Air Status and Trends Network (CASTNET). <http://www.epa.gov/castnet/index.html>.
6 Accessed 2/4/10b.
- 7 -----. 2010c. Integrated Compliance Information System (ICIS).
8 <http://www.epa.gov/compliance/data/systems/icis/index.html>. Accessed 1/11/10c.
- 9 U.S. Fish and Wildlife Service. 2008. Fish Passage.
10 <http://www.fws.gov/yellowstonerivercoordinator/fishpassage.html>. Accessed 3/23/11.
- 11 U.S. Geological Survey. 2008. National Water Information System (NWISWeb) Data Availble on the
12 World Wide Web. <http://waterdata.usgs.gov/nwis/>. Accessed 9/25/08.
- 13 Uchrin, C. G. and W. K. Ahlert. 1985. In Situ Sediment Oxygen Deman Determinations Inthe Passaic River
14 (NJ) During the Late Summer/Early Fall 1983. *Wat.Res.* 19(1985): 1141-1144.
- 15 University of Utah Department of Atmospheric Sciences. 2009. MesoWest.
16 <http://mesowest.utah.edu/index.html>. Accessed 5/28/09.
- 17 Vaillancourt, B. 2008. The Importance of Quenching. [http://sogasex.wordpress.com/2008/03/27/the-](http://sogasex.wordpress.com/2008/03/27/the-importance-of-quenching/)
18 [importance-of-quenching/](http://sogasex.wordpress.com/2008/03/27/the-importance-of-quenching/).
- 19 Van Duin, E. H. S., G. Blom, F. Johannes Los, R. Maffione, R. Zimmerman, C. F. Cerco, M. Dortch, and E. P.
20 H. Best. 2001. Modeling Underwater Light Climate in Relation to Sedimenation, Resuspension,
21 Water Quality and Autotrophic Growth. *Hydrobiologia.* 444(2001): 25-42.
- 22 Van Nieuwenhuysse, E. E. and J. R. Jones. 1996. Phosphorus-Chlorophyll Relationships in Temperate
23 Streams and Its Variation With Stream Catchment Area. *Can.J.Fish.Aquat.Sci.* 53(1996): 99-105.
- 24 Van Orden, G. N. and C. G. Uchrin. 1993. The Study of Dissolved Oxygen Dynamics in the Whippany
25 River, New Jersey Using the QUAL2E Model. *Ecological Modelling.* 70(1-2): 1-17.
- 26 Vandenberghe, V., W. Bauwens, and P. A. Vanrolleghem. 2007. Evaluation of Uncertainty Propagation
27 into River Water Quality Predictions to Guide Future Monitoring Campaigns. *Environmental*
28 *Modelling and Software.* 22(2007): 725-732.
- 29 Vannote, R. L., G. W. Minshall, K. W. Cummins, J. R. Sedell, and C. E. Cushing. 1980. The River Continuum
30 Concept. *Canadian Journal of Fisheries and Aquatic Sciences.* 37(1980): 130-137.

- 1 Vasconcelos, V. 2006. Eutrophication, Toxic Cyanobacteria and Cyanotoxins: When Ecosystems Cry for
2 Help. *Limnetica*. 25(1-2): 425-432.
- 3 Vemula, V. R. S., P. P. Mujumdar, and S. Ghosh. 2004. Risk Evaluation in Water Quality Management of a
4 River System. *Journal of Water Resources Planning and Management*. 130(5): 411-423.
- 5 Vitousek, P. M., J. D. Aber, R. W. Howarth, G. E. Likens, P. A. Matson, D. W. Schindler, W. H. Schlesinger,
6 and D. G. Tilman. 1997. Human Alteration of the Global Nitrogen Cycle: Sources and
7 Consequences. *Ecological Applications*. 7(3): 737-750.
- 8 Walling, D. E. and B. W. Webb. 1992. "Water Quality: I. Physical Characteristics," in *The Rivers*
9 *Handbook*, Calow, P. and Petts, G. E., (Oxford: Blackwell Scientific): 48-72.
- 10 Wang, L., D. M. Robertson, and P. J. Garrison. 2007. Linkages Between Nutrients and Assemblages of
11 Macroinvertebrates and Fish in Wadeable Streams: Implication to Nutrient Criteria
12 Development. *Environmental Management*. 39: 194-212.
- 13 Watson, Vicki, Perry Berlind, and Loren L. Bahls. 1990. Control of Algal Standing Crop By P and N in the
14 Clark Fork River. In: Proceedings of the 1990 Clark Fork River Symposium. Apr. 20, 1990.
15 Missoula, MT: University of Montana.
- 16 Watson, Vicki and Bonnie Gestring. 1996. Monitoring Algae Levels in the Clark Fork River. *Intermountain*
17 *Journal of Sciences*. 2: 17-26.
- 18 Weigel, B. M. and D. M. Robertson. 2007. Identifying Biotic Integrity and Water Chemistry Relations in
19 Nonwadeable Rivers of Wisconsin: Toward the Development of Nutrient Criteria. *Environmental*
20 *Management*. 40(2007): 691-708.
- 21 Weitkamp, D. E. and M. Katz. 1980. A Review of Dissolved Gas Supersaturation Literature. *Transactions*
22 *of the American Fisheries Society*. 109: 659-702.
- 23 Welch, E. B. 1992. *Ecological Effects of Wastewater*, London: Chapman and Hill.
- 24 Welch, E. B., J. M. Jacoby, R. R. Horner, and M. R. Seeley. 1988. Nuisance Biomass Levels of Periphytic
25 Algae in Streams. *Hydrobiologia*. 157: 161-168.
- 26 Western Regional Climate Center. 2009. Western Regional Climate Center (WRCC) Online Access.
27 <http://www.wrcc.dri.edu/>. Accessed 5/15/09.
- 28 Wetzel, R. G. and G. E. Likens. 1991. *Limnological Analyses*, 2nd ed., New York, NY: Springer-Verlag.
- 29 White, R. G. and R. G. Bramblett. 1993. The Yellowstone River: Its Fish and Fisheries. In L.W. Hesses, C.B.
30 Stalnaker, N.G. Bensons (Eds.). In: Department of the Interior, National Biological Survey.

- 1 Biological Report 19 (ed.). Proceedings of the Symposium on Restoration Planning for the
2 Rivers of the Mississippi River Ecosystem. Washington, D.C. 396-414.
- 3 Whitehead, P. W. and P. Young. 1979. Water Quality in River Systems: Monte-Carlo Analysis. *Water*
4 *Resources Research*. 15(2): 451-459.
- 5 Whiting, P. J., G. Matisoff, W. Fornes, and F. M. Soster. 2005. Suspended Sediment Sources and
6 Transport Distances in the Yellowstone River Basin. *Geological Society of American Bulletin*.
7 117(3-4): 515-529.
- 8 Whitton, B. A. 1970. Review Paper: Biology of *Cladophora* in Freshwaters. *Water Research*. 4: 457-476.
- 9 Wilcox, S. and W. Marion. 2008. Users Manual for TMY3 Data Sets. Report NREL/TP-581-43156.
- 10 Wilson, M. A. and S. R. Carpenter. 1999. Economic Valuation of Freshwater Ecosystem Services in the
11 United States: 1971-1997. *Ecological Applications*. 9(3): 772-783.
- 12 Wong, S. L. and B. Clark. 1975. Field Determination of the Critical Nutrient Concentrations for
13 *Cladophora* in Streams. *Journal of the Fisheries Research Board of Canada*. 33: 85-92.
- 14 Wool, T. A. 2009. TMDL Modeling Toolbox. <http://www.epa.gov/athens/wwqtsc/Toolbox-overview.pdf>.
15 Accessed 5/1/07.
- 16 Zelt, R. B., G. K. Boughton, K. A. Miller, J. P. Mason, and L. M. Gianakos. 1999. Environmental Setting of
17 the Yellowstone River Basin, Montana, North Dakota, and Wyoming. Cheyenne, WY: U.S.
18 Geological Survey. Report Water-Resources Investigations Report 98-4269.
19
20